

---

# Instrument Set Catalogue

---

## Anterior Cervical Plate System Instrument Set

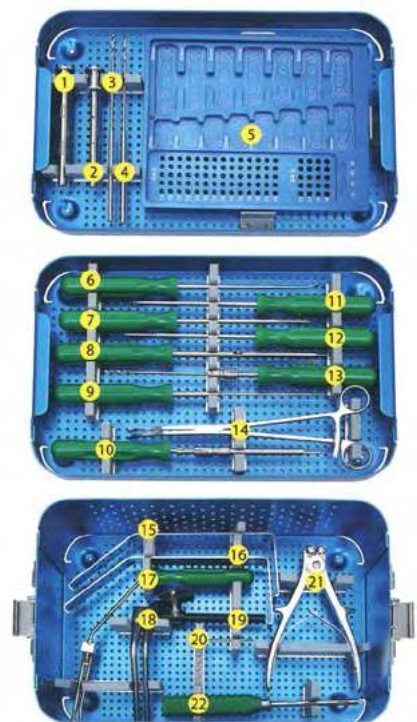

A2200-0200	ANTERIOR CERVICAL PLATE SYSTEM INSTRUMENT SET
A2200-0201	SCREWDRIVER SLEEVE
A2200-0202	SCREWDRIVER SLEEVE
A2200-0203	DRILL BIT
A2200-0204	DRILL BIT
A2200-0205	PLATE AND SCREW BOX
A2200-0206	CURETTE
A2200-0207	HEXAGONAL SCREWDRIVER
A2200-0208	BRACE SCREWDRIVER
A2200-0209	AWL
A2200-0210	TAP
A2200-0211	NUT SCREWDRIVER
A2200-0212	HEXAGONAL SCREWDRIVER
A2200-0213	HEXAGONAL SCREWDRIVER
A2200-0214	PLATE HOLDING FORCEPS
A2200-0215	CERVICAL HOOK
A2200-0216	CERVICAL HOOK
A2200-0217	GUIDE
A2200-0218	DISTRACTOR
A2200-0219	BRACE SCREW
A2200-0220	LOCATION SCREW
A2200-0221	PLATE BENDER
A2200-0222	LOCATION SCREW SCREWDRIVER
A2200-0223	ALUMINIUM BOX

## Posterior Cervical Fixation System Instrument Set

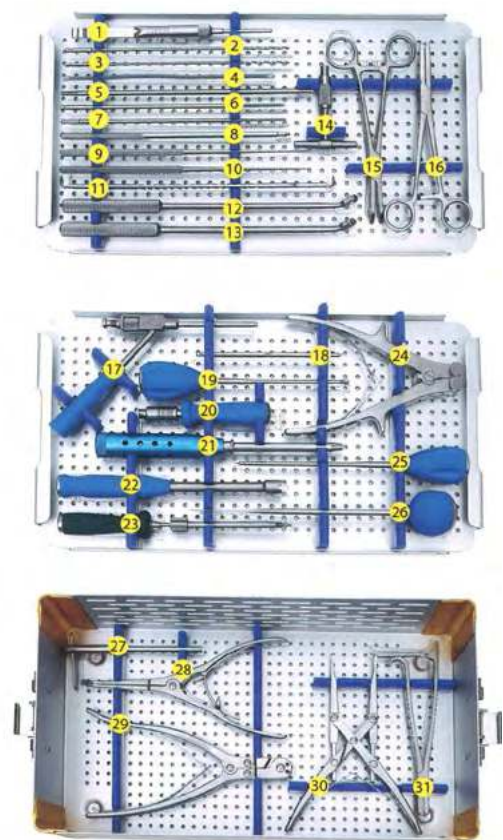

A2200-0300	POSTERIOR CERVICAL FIXATION SYSTEM INSTRUMENT SET
A2200-0301	DEPTH GAUGE 4-40 MM
A2200-0302	DRILL BIT 2,7 MM
A2200-0303	DRILL BIT 2,4 MM
A2200-0304	TRAIL ROD
A2200-0305	SCREWDRIVER HEXAGONAL 2,5 MM
A2200-0306	TAP Ø4,0
A2200-0307	TAP Ø3,5
A2200-0308	NUT HOLDER
A2200-0309	FEELER FOR SCREW CHANNEL BENT
A2200-0310	FEELER FOR SCREW CHANNEL STRAIGHT
A2200-0311	DISTRACTOR
A2200-0312	IN-SITU BENDING IRON L
A2200-0313	IN-SITU BENDING IRON R
A2200-0314	T-HANDLE QUICK COUPLING
A2200-0315	HOOK HOLDING FORCEPS
A2200-0316	ROD HOLDING FORCEPS
A2200-0317	GUIDE
A2200-0318	SCREWDRIVER HEXAGONAL 2,5 MM
A2200-0319	ROD PUSHING FORCEPS
A2200-0320	STRAIGHT HANDLE QUICK COUPLING
A2200-0321	INSERT DEVICE FOR FIXATION PIN
A2200-0322	COUNTER TORQUE
A2200-0323	SCREWDRIVER FOR POLYAXIAL SCREW
A2200-0324	ROD BENDER
A2200-0325	AWL
A2200-0326	AWL
A2200-0327	PROTECTION SLEEVE
A2200-0328	DISTRACTION FORCEPS
A2200-0329	ROD CUTTER
A2200-0330	PARALLEL COMPRESSION FORCEPS
A2200-0331	ROD TWIST
A2200-0332	ALUMINIUM BOX

## Anterior Thoracic & Thoracolumbar Plate Instrument Set

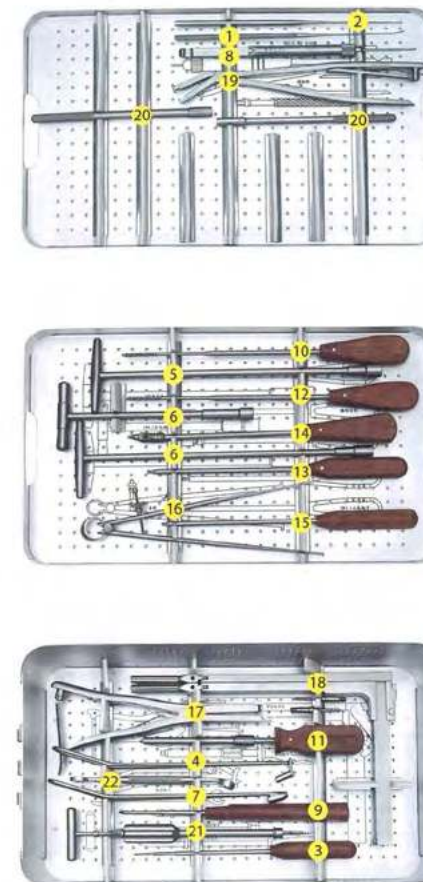

A2200-0400	ANTERIOR THORACIC & THORACOLUMBAR PLATE SYSTEM INSTRUMENT SET
A2200-0401	CURVED GUIDE PIN
A2200-0402	STRAIGHT GUIDE PIN
A2200-0403	DRILL BIT
A2200-0404	OBTURATOR
A2200-0405	NUT DRIVER SW8
A2200-0406	NUT DRIVER SW8
A2200-0407	DRILL GUIDE
A2200-0408	DETECTOR
A2200-0409	HOLE ENLARGER
A2200-0410	TAP 6,5 MM
A2200-0411	SCREW HOLDING DRIVER
A2200-0412	TAP 6 MM
A2200-0413	SCREWDRIVER
A2200-0414	UNIVERSAL SCREWDRIVER
A2200-0415	SCREWDRIVER
A2200-0416	CALIPERS
A2200-0417	COMPRESSION CLAMP 3 MM
A2200-0418	DISTRACTOR CLAMP
A2200-0419	PLATE HOLDING CLAMP
A2200-0420	HOLDING BOLT SW8
A2200-0421	COMBINATION WRENCH
A2200-0422	WRENCH SW11
A2200-0423	ALUMINIUM BOX

## Spinal Pedicle Screw System Instrument Set

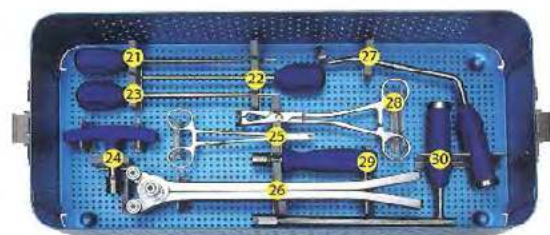
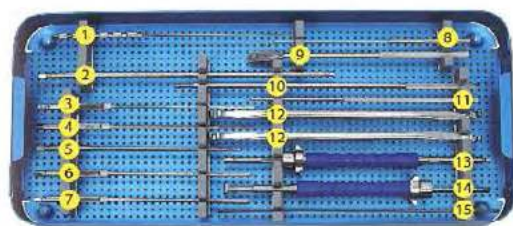

A2200-0100	SPINAL PEDICLES CREW SYSTEM INSTRUMENT SET
A2200-0101	FEELER FOR SCREW CHANNEL STRAIGHT
A2200-0102	HEXAGONAL SCREWDRIVER FOR SREW NUT SW5,0
A2200-0103	TAP Ø4,0
A2200-0104	TAP Ø5,0
A2200-0105	SCREWDRIVER HEXAGONAL 3,5 MM FOR CROSSLINK NUT
A2200-0106	TAP Ø6,0
A2200-0107	TAP Ø7,0
A2200-0108	FEELER FOR SCREW CHANNEL BENT
A2200-0109	SCREW CUTTER FOR LONG ARM SCREW
A2200-0110	SCREW NUT HOLDER HEXAGONAL
A2200-0111	CROSSLINK NUT HOLDER HEXAGONAL
A2200-0112	IN-SITU BENDING IRON
A2200-0113	SCREWDRIVER FOR POLYAXIAL SCREW
A2200-0114	SCREWDRIVER FOR MONOAXIAL SCREW
A2200-0115	TRAIL ROD
A2200-0116	INSERT DEVICE FOR FIXATION PIN
A2200-0117	ROD PUSHERIAL
A2200-0118	PARALLEL SPREADER
A2200-0119	PARALLEL COMPRESSOR
A2200-0120	ROD TWIST
A2200-0121	PEDICLE PROBE STRAIGHT
A2200-0122	PEDICLE PROBE BENT
A2200-0123	AWL
A2200-0124	T-HANDLE QUICK COUPLING
A2200-0125	ROD HOLDING FORCEPS
A2200-0126	ROD BENDER
A2200-0127	COUNTER TORQUE FOR CUTTER
A2200-0128	ROD PUSHING FORCEPS
A2200-0129	STRAIGHT HANDLE QUICK COUPLING
A2200-0130	COUNTER TORQUE
A2200-0131	ALUMINIUM BOX

## Humeral Intramedullary Nail Instrument Set

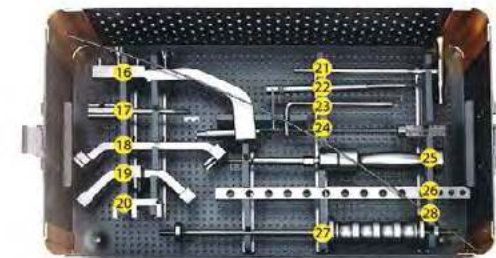
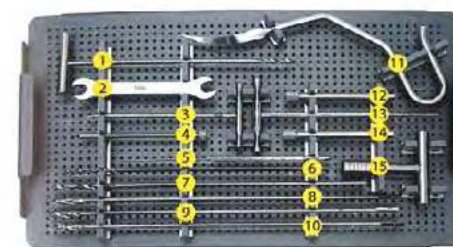

## Tibia Intramedullary Nail Instrument Set

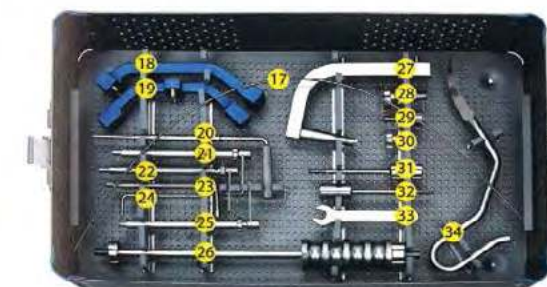
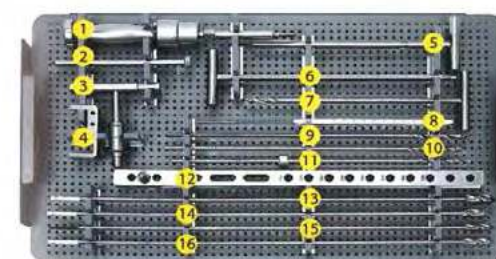

A1200-0100	HUMERAL INTRAMEDULLARY NAIL INSTRUMENT SET
A1200-0101	DRILL BIT 5,2 MM
A1200-0102	OPEN WRENCH
A1200-0103	TAP 3,5 MM
A1200-0104	DISTAL POSITIONING FRAME
A1200-0105	DEPTH GAUGE 0-60 MM
A1200-0106	DRILL BIT 2,9*250 MM
A1200-0107	DRILL BIT 5,2*300 MM
A1200-0108	REAMER 8,5*340 MM
A1200-0109	REAMER 8,0*340 MM
A1200-0110	REAMER 7,5*340 MM
A1200-0111	AWL
A1200-0112	SLEEVE
A1200-0113	SCREWDRIVER SW2,5
A1200-0114	SLEEVE
A1200-0115	QUICK COUPLING T-HANDLE
A1200-0116	SIGHTING DEVICE HANDLE
A1200-0117	NAIL CONNECTOR
A1200-0118	DISTAL GUIDE
A1200-0119	PROXIMAL GUIDE
A1200-0120	FIXED CONNECTOR
A1200-0121	LOCATION ROD
A1200-0122	DRILL SLEEVE
A1200-0123	HEXAGONAL WRENCH
A1200-0124	GAUGE CANNULA
A1200-0125	UNIVERSAL JOINT
A1200-0126	GUIDE ROD
A1200-0127	HAMMER
A1200-0128	GUIDE WIRE
A1200-0129	ALUMINIUM BOX

A1200-0200	TIBIAL INTRAMEDULLARY NAIL INSTRUMENT SET
A1200-0201	UNIVERSAL JOINT
A1200-0202	DRILL SLEEVE
A1200-0203	QUICK COUPLING T-HANDLE
A1200-0204	FIXED CONNECTOR
A1200-0205	LOCATION ROD
A1200-0206	SCREWDRIVER
A1200-0207	T-HANDLE DRILL BIT 5,2 MM
A1200-0208	DEPTH GAUGE 10-100 MM
A1200-0209	DRILL BIT 5,2*300 MM
A1200-0210	DRILL BIT 4,0* 300 MM
A1200-0211	DRILL BIT WITH LIMITATOR 4,0*300 MM
A1200-0212	GUIDE ROD
A1200-0213	REAMER 8 MM
A1200-0214	REAMER 9 MM
A1200-0215	REAMER 10 MM
A1200-0216	REAMER 11 MM
A1200-0217	GUIDE WIRE
A1200-0218	DISTAL GUIDE
A1200-0219	PROXIMAL GUIDE
A1200-0220	LOCATION FORCEPS
A1200-0221	DRILL SLEEVE
A1200-0222	DRILL SLEEVE
A1200-0223	HEXAGONAL WRENCH
A1200-0224	HEXAGONAL WRENCH
A1200-0225	DRILL SLEEVE
A1200-0226	HAMMER
A1200-0227	SIGHTING DEVICE HANDLE
A1200-0228	BOLT
A1200-0229	BOLT
A1200-0230	BOLT
A1200-0231	NAIL CONNECTOR SOLID
A1200-0232	NAIL CONNECTOR CANNULATED
A1200-0233	OPEN WRENCH
A1200-0234	AWL
A1200-0235	ALUMINIUM BOX

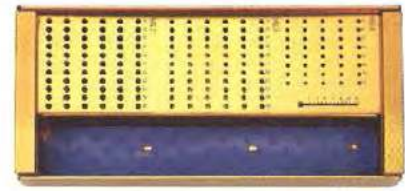

1.5/2.0/2.7 Screw Box 5100-0101



3.5/4.0 Screw Box 5100-0201



4.5/6.5 Screw Box 5100-0301



3.5/4.0 Screw Rack 5100-0401



4.5/6.5 Screw Rack 5100-0501



K-wire Rack 5100-1201



Small Fragment Locking Screw Rack 5100-0601



Large Fragment Locking Screw Rack 5100-0701

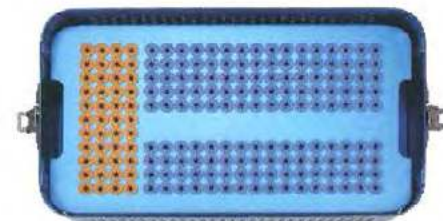

Spinal Pedicle Screw Box 5100-0801

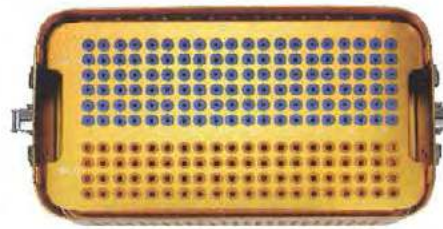

Posterior Cervical Screw Box 5100-0901

### Small Fragment Locking Plate Instrument Set



- A3200-0100 SMALL FRAGMENT LOCKING PLATE INSTRUMENT SET
- A3200-0101 DRILL BIT Ø2,0X110 MM
- A3200-0102 DRILL BIT Ø2,7X130 MM
- A3200-0103 DRILL BIT Ø3,2X130 MM
- A3200-0104 TAP FOR CORTEX SCREW 2,7 MM
- A3200-0105 TAP FOR CORTEX SCREW 3,5 MM
- A3200-0106 TAP CANCELLOUS 4,0 MM
- A3200-0107 HOLLOW REAMER SMALL
- A3200-0108 COUNTERSINK Ø6,0
- A3200-0109 EXTRACTION SCREW HEXAGONAL 2,5 MM CONICAL
- A3200-0110 HEXAGONAL SCREWDRIVER SHAFT 2,0 MM QUICK COUPLING
- A3200-0111 HEXAGONAL SCREWDRIVER SHAFT 2,5 MM QUICK COUPLING
- A3200-0112 HEXAGONAL SCREWDRIVER 2,0 MM
- A3200-0113 HEXAGONAL SCREWDRIVER 2,5 MM
- A3200-0114 BENDING IRON SMALL RIGHT
- A3200-0115 BENDING IRON SMALL LEFT
- A3200-0116 SELF-CENTERING BONE HOLDING FORCEPS (190 MM)
- A3200-0117 SHARP REDUCTION FORCEP (170 MM)
- A3200-0118 OBLIQUE REDUCTION FORCEP (190 MM)
- A3200-0119 SLEEVE KEY
- A3200-0120 GUIDE WIRE Ø1,8X200 MM
- A3200-0121 NEUTRAL AND LOAD DRILL GUIDE
- A3200-0122 THREADED DRILL GUIDE (SLEEVE) 2,0 MM
- A3200-0123 THREADED DRILL GUIDE (SLEEVE) 2,7 MM
- A3200-0124 SCREW FORCEPS
- A3200-0125 T-HANDLE QUICK COUPLING
- A3200-0126 TORQUE LIMITING HANDLE 0,8N,M
- A3200-0127 TORQUE LIMITING HANDLE 1,5N,M
- A3200-0128 DEPTH GAUGE 0-50 MM
- A3200-0129 DEPTH GAUGE 0-70 MM
- A3200-0130 ALUMINIUM CASE & TRAYS

### Large Fragment Locking Plate Instrument Set



- A3200-0200 LARGE FRAGMENT LOCKING PLATE INSTRUMENT SET
- A3200-0201 DRILL BIT Ø3,2X150 MM
- A3200-0202 DRILL BIT Ø4,1X250 MM
- A3200-0203 DRILL BIT Ø4,5X190 MM
- A3200-0204 TAP FOR CORTEX SCREW 4,5 MM
- A3200-0205 TAP FOR CORTEX SCREW 5,0 MM
- A3200-0206 TAP CANCELLOUS 6,5 MM
- A3200-0207 HOLLOW REAMER LARGE
- A3200-0208 COUNTERSINK Ø8,0
- A3200-0209 EXTRACTION SCREW HEXAGONAL 3,5 MM CONICAL
- A3200-0210 HEXAGONAL SCREWDRIVER SHAFT 3,5 MM QUICK COUPLING
- A3200-0211 HEXAGONAL SCREWDRIVER 3,5 MM
- A3200-0212 SLEEVE KEY
- A3200-0213 GUIDE WIRE Ø1,8X250 MM
- A3200-0214 NEUTRAL AND LOAD DRILL GUIDE 3,2/4,5 MM
- A3200-0215 THREADED DRILL GUIDE (SLEEVE) 4,1 MM
- A3200-0216 SCREW FORCEPS
- A3200-0217 BENDING IRON LARGE RIGHT
- A3200-0218 BENDING IRON LARGE LEFT
- A3200-0219 SELF-CENTERING BONE HOLDING FORCEPS (270 MM)
- A3200-0220 SHARP REDUCTION FORCEP (200 MM)
- A3200-0221 OBLIQUE REDUCTION FORCEP (230 MM)
- A3200-0222 ALUMINIUM CASE & TRAYS (LARGE)
- A3200-0223 T-HANDLE QUICK COUPLING
- A3200-0224 TORQUE LIMITING HANDLE 4,0N,M
- A3200-0225 DEPTH GAUGE 0-120 MM

## Reversed Femoral & Gama Intramedullary Nail Instrument Set

### A1200-0800

- 1200-0801 LOCKING PIPE
- 1200-0802 SOFT TISSUE SEPARATING DEVICE LONG
- 1200-0803 LOCKING DRILLS Ø4,3
- 1200-0804 LOCKING NAIL BONE DRILL Ø4,3
- 1200-0805 LIMIT DEVICE Ø4,3
- 1200-0806 LOCKING HOLE DEPTH GAUGE
- 1200-0807 LOCKING SPANNER SW4,0
- 1200-0808 FEMUR NECK NAIL/TAIL SPANNER SWS/M3,5
- 1200-0809 FEMUR NECK NAIL DRILL Ø6,4
- 1200-0810 LIMIT DEVICE Ø6,4
- 1200-0811 FEMUR NECK NAIL DRILL Ø6,4
- 1200-0812 FEMUR NECK GUIDE DEPTH GAUGE Ø2,5\*320
- 1200-0813 FEMUR NECK SCREW GUIDE PIN Ø2,5\*320
- 1200-0814 FEMUR NECK GUIDE PIN Ø2,5\*320
- 1200-0815 FEMUR NECK GUIDE DRILL SET Ø2,5
- 1200-0816 PROXIMAL ENLARGEMENT
- 1200-0817 PROXIMAL HARD ENLARGE LIMIT DEVICE
- 1200-0818 LIMIT SPANNER SW3
- 1200-0819 PROTECTION SKIN BOARD
- 1200-0820 GUIDE PIN DEVICE
- 1200-0821AWL
- 1200-0822 HANDLE
- 1200-0823 REDUCTION ROD (GUIDE PIN)
- 1200-0824 SOFT KNIFE ROD Ø2,5/Ø8
- 1200-0825 SOFT KNIFE ROD Ø8,5
- 1200-0826 SOFT KNIFE ROD Ø9
- 1200-0827 SOFT KNIFE ROD Ø9,5
- 1200-0828 SOFT KNIFE ROD Ø10
- 1200-0829 SOFT KNIFE ROD Ø10,5
- 1200-0830 SOFT KNIFE ROD Ø11
- 1200-0831 SOFT KNIFE ROD Ø11,5
- 1200-0832 SOFT KNIFE ROD Ø12
- 1200-0833 SOFT KNIFE ROD Ø12,5
- 1200-0834 SOFT KNIFE ROD Ø13
- 1200-0835 BALL HEAD GUIDE PIN Ø2,5/Ø4
- 1200-0835 PROXIMAL GUIDE ROD
- 1200-0837 CONNECTING SCREW SPANNER SW6,5
- 1200-0838 DISTAL GUIDE ROD
- 1200-0839 DISTAL POSITIONING FRAME
- 1200-0840 CONNECTING GUIDE PIN LOCKING WHEEL
- 1200-0841 POSITIONING CARD
- 1200-0842 POSITIONING ROD
- 1200-0843 PULL DEVICE
- 1200-0844 HANDLE
- 1200-0845 CONNECTING SCREW
- 1200-0846 CONNECTING HANDLE WHEEL
- 1200-0847 LOCKING WHEEL SPANNER SW5
- 1200-0848 POSITIONING PIPE
- 1200-0849 SOFT TISSUE SEPARATING DEVICE SHORT
- 1200-0850 POSITIONING DRILL SET Ø5,2
- 1200-0851 POSITIONING BONE DRILL Ø5,2
- 1200-0852 POSITIONING FLAT DRILL Ø5,2
- 1200-0853 CONNECTING SCREW UNIVERSAL SPANNER SW6,5
- 1200-0854 MAIN NAIL PULL CONNECTING ROD
- 1200-0855 ALUMINIUM BOX

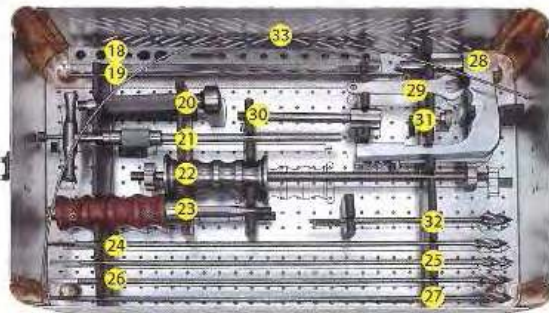
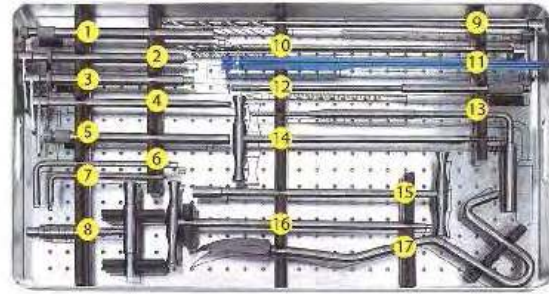

## Femoral Reconstruction Intramedullary Nail Instrument Set

- A1200-0501 AWL
- A1200-0502 K-WIRE
- A1200-0503 DRILL BIT WITH LIMITATOR Ø3,5
- A1200-0504 DRILL BIT
- A1200-0505 DRILL BIT
- A1200-0506 T-HANDLE QUICK COUPLING LOCK
- A1200-0507 LOCK
- A1200-0508 T-LOCATION FORCEPS
- A1200-0509 DEPTH GAUGE
- A1200-0510 STRAIGHT HANDLE
- A1200-0511 WIRE DEPTH GAUGE
- A1200-0512 L-SHAPED LOCATION FORCEPS
- A1200-0513 LOCATION FORCEPS
- A1200-0514 FORCING CONE
- A1200-0515 TAP
- A1200-0516 FORCING CONE
- A1200-0517 WRENCH
- A1200-0518 HEXAGONAL SCREWDRIVER
- A1200-0519 L-SHAPED LOCATION FORCEPS
- A1200-0520 WRENCH
- A1200-0521 L-WRENCH LARGE
- A1200-0522 L-WRENCH SMALL
- A1200-0523 GUIDE DRILL + SLEEVE
- A1200-0524 GUIDE DRILL + SLEEVE
- A1200-0525 GUIDE DRILL + SLEEVE
- A1200-0526 GUIDE DRILL + SLEEVE
- A1200-0527 GUIDE DRILL + SLEEVE
- A1200-0528 GUIDE HANDLE
- A1200-0529 GUIDE ROD
- A1200-0530 IMPACTOR AND EXTRACTOR
- A1200-0531 REAMER Ø10,4
- A1200-0532 REAMER Ø11
- A1200-0533 REAMER Ø12
- A1200-0534 REAMER Ø12,5
- A1200-0535 REAMER Ø13
- A1200-0536 UNIVERSAL JOINT
- A1200-0537 GUIDE WIRE
- A1200-0538 GUIDE BAR
- A1200-0539 ALUMINIUM BOX

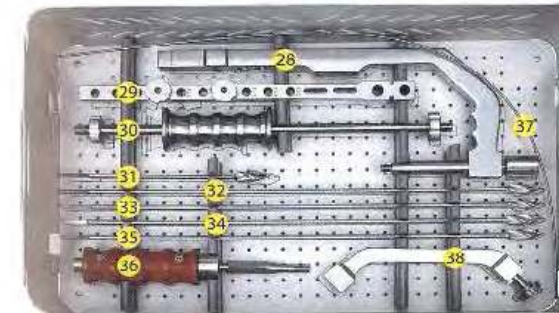
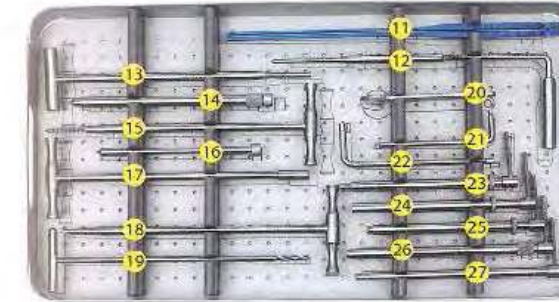
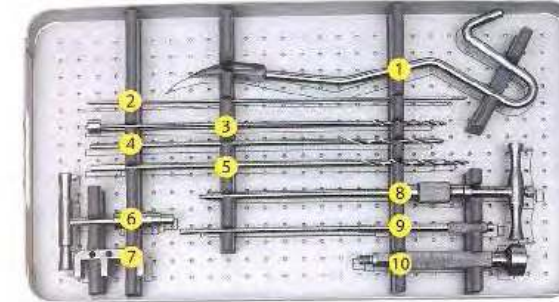

## Elastic Nail Instrument Set

- A1200-0600 ELASTIC NAIL INSTRUMENT SET
- A1200-0601 HAMMER
- A1200-0602 AWL
- A1200-0603 LOCKING PLIERS
- A1200-0604 CUTTER
- A1200-0605 HAMMER GUIDE
- A1200-0606 CUTTER
- A1200-0607 DOUBLE DRILL SLEEVE 3,2/4,5 MM
- A1200-0608 END CUP INSERTER SMALL
- \*A1200-0609 END CUP INSERTER LARGE
- A1200-0610 DRILL BIT Ø2,7\*115 MM
- A1200-0611 DRILL BIT Ø3,2\*150 MM
- A1200-0612 DRILL BIT Ø4,5\*150 MM
- A1200-0613 ELASTIC NAIL INSERTER
- A1200-0614 STANDARD TAMP
- A1200-0615 BEVELED TAMP
- A1200-0616 BENDER
- A1200-0617 BENDER
- A1200-0618 ALUMINIUM BOX

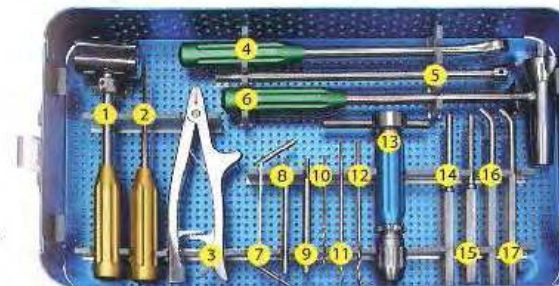
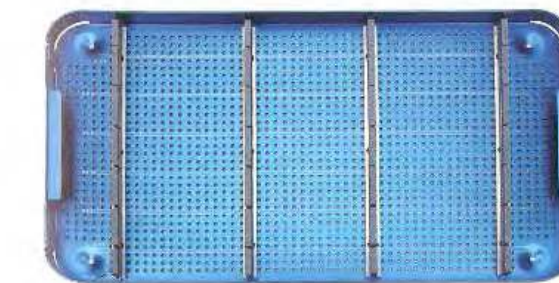

## New Femoral Reconstruction Intramedullary Nail Instrument Set

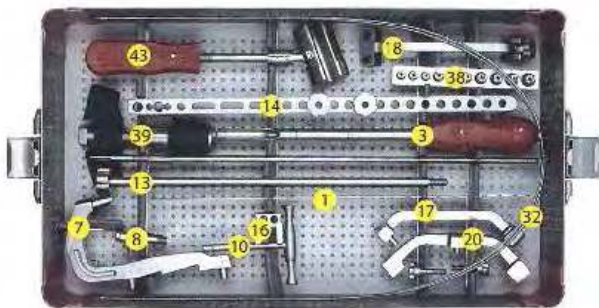
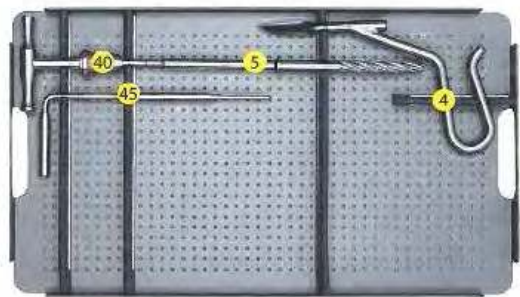
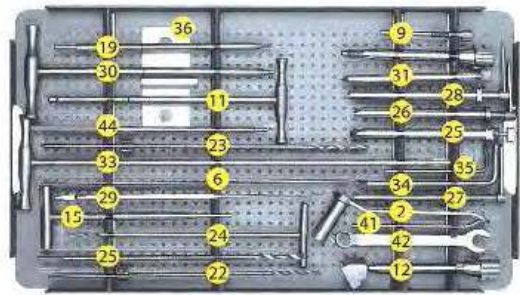

- A1200-0500 FEMORAL SHORT-LONG RECONSTRUCTION INTRAMEDULLARY NAIL INSTRUMENT SET
- A1200-0501 AWL
- A1200-0502 K-WIRE
- A1200-0503 DRILL BIT WITH LIMITATOR Ø3,5
- A1200-0504 DRILL BIT
- A1200-0505 DRILL BIT
- A1200-0506 T-HANDLE QUICK COUPLING
- A1200-0507 LOCK
- A1200-0508 T-LOCATION FORCEPS
- A1200-0509 DEPTH GAUGE
- A1200-0510 STRAIGHT HANDLE
- A1200-0511 WIRE DEPTH GAUGE
- A1200-0512 L-SHAPED LOCATION FORCEPS
- A1200-0513 LOCATION FORCEPS
- A1200-0514 FORCING CONE
- A1200-0515 TAP
- A1200-0516 FORCING CONE
- A1200-0517 WRENCH
- A1200-0518 HEXAGONAL SCREWDRIVER
- A1200-0519 L-SHAPED LOCATION FORCEPS
- A1200-0520 WRENCH
- A1200-0521 L-WRENCH LARGE
- A1200-0522 L-WRENCH SMALL
- A1200-0523 GUIDE DRILL + SLEEVE
- A1200-0524 GUIDE DRILL + SLEEVE
- A1200-0525 GUIDE DRILL + SLEEVE
- A1200-0526 GUIDE DRILL + SLEEVE
- A1200-0527 GUIDE DRILL + SLEEVE
- A1200-0528 GUIDE HANDLE
- A1200-0529 GUIDE ROD
- A1200-0530 IMPACTOR AND EXTRACTOR
- A1200-0531 REAMER Ø10,4
- A1200-0532 REAMER Ø11
- A1200-0533 REAMER Ø12
- A1200-0534 REAMER Ø12,5
- A1200-0535 REAMER Ø13
- A1200-0536 UNIVERSAL JOINT
- A1200-0537 GUIDE WIRE
- A1200-0538 GUIDE BAR
- A1200-0539 ALUMINIUM BOX

## ANT Tibia Intramedullary Nail Instrument Set

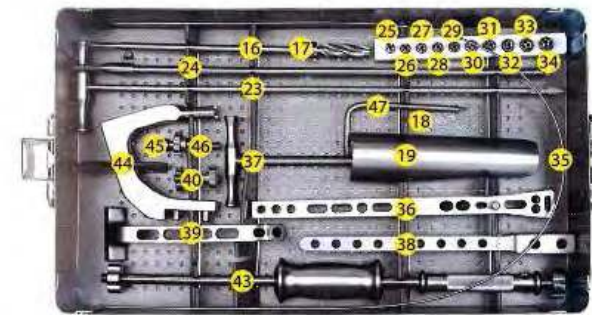
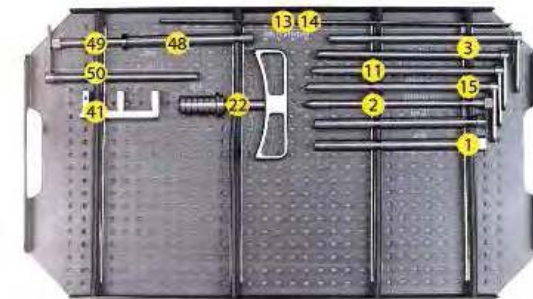
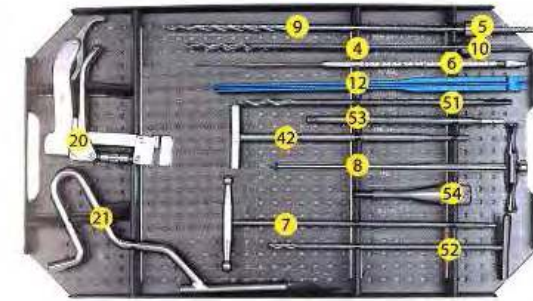

- A1200-0900 ANT TIBIAL INTRAMEDULLARY NAIL INSTRUMENT SET
- A1200-0901 PROXIMAL KNIFE ROD T HANDLE
- A1200-0902 PROXIMAL KNIFE ROD Ø12/Ø3,2
- A1200-0903 RIGHT ANGLE LOCKING ROD
- A1200-0904" CANNULATED AWL
- A1200-0905" NAIL DRIVER EXTRACTOR CONNECTOR
- A1200-0906" WRENCH
- A1200-0907" CONNECTOR WRENCH
- A1200-0908" PROTECTION SLEEVE Ø12
- A1200-0909" POSITIONING ROD SLEEVE Ø3,2
- A1200-0910" FRAME RODS LOCKING SCREW DRIVER SW5
- A1200-0911" DRILL STOPPER SCREW DRIVER SW3
- A1200-0912" CANCELLOUS SCREW DRILL SLEEVE SET Ø3,2,8,6,11
- A1200-0913" DRILL SLEEVE SET Ø4,0
- A1200-0914" TROCAR
- A1200-0915" NAIL EXTRACT CONNECTION ROD
- A1200-0816" COMPRESSION BOLT
- A1200-0917" BONE DRILL Ø3,2
- A1200-0918" DRILL STOPPER
- A1200-0919" BONE DRILL Ø5,2
- A1200-0920" POSITIONING ROD FLAT HEAD DRILL Ø5,2
- A1200-0921" POSITION ROD
- A1200-0922" DEPTH GAUGE
- A1200-0923 THREADED GUIDE PIN
- A1200-0924 GUIDE PIN GUIDE
- A1200-0925 BONE DRILL Ø4,0
- A1200-0926 DRILL STOPPER Ø4,0
- A1200-0927 HEXAGONAL SCREW HOLDER SW3,5
- A1200-0928" CONNECTING ROD UNIVERSAL DRIVER SW6,5
- A1200-0929" LOCKING SCREW DRIVER SW3,5
- A1200-0930" PROTECTION PLATE
- A1200-0931" GUIDE PIN
- A1200-0932" SLIDING HAMMER
- A1200-0933" FRAME GUIDE ROD
- A1200-0934" GUIDE PIN HOLDER
- A1200-0935" REAMER SHAFT
- A1200-0935" SLIDING HAMMER GUIDE ROD
- A1200-0937" DEVELOPING CALCULATOR
- A1200-0938" CONNECTING BOLT
- A1200-0939" INSERTION HANDLE
- A1200-0940" U-SHAPED LOCKING BLOCK
- A1200-0941" CONNECTING ROD SCREWDRIVER SW6,5
- A1200-0942 DISTAL TARGET DEVICE
- A1200-0943 FLEXIBLE REAMER BIT Ø7,5-12
- A1200-0944 CANNULATED CHISEL Ø12/3,2
- A1200-0945 PROXIMAL TARGET DEVICE
- A1200-0946 PROXIMAL CANCELLOUS TARGET DEVICE
- A1200-0947 PROXIMAL CANCELLOUS TARGET DEVICE
- A1200-0948 ALUMINIUM BOX

## Small Fragment Instrument Set

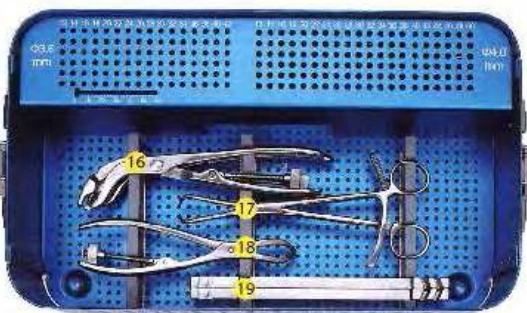
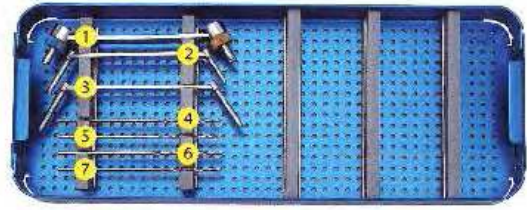

- A4200-0100 SMALL FRAGMENT INSTRUMENT SET
- A4200-0101 NEUTRAL AND LOAD DRILL GUIDE Ø2,5
- A4200-0102 DRILL & TAP GUIDE (Ø2,5/Ø3,5)
- A4200-0103 DRILL & TAP GUIDE (Ø3,5/Ø4,0)
- A4200-0104 DRILL BIT (Ø2,5\*115 MM)
- A4200-0105 DRILL BIT (Ø2,5\*115 MM)
- A4200-0106 DRILL BIT (Ø3,2\*115 MM)
- A4200-0107 DRILL BIT (Ø3,2\*115 MM)
- A4200-0108 PERIOSTEAL ELEVATOR 6 MM
- A4200-0109 TAP CANCELLOUS 4,0 MM
- A4200-0110 DEPTH GAUGE (0-60 MM)
- A4200-0111 COUNTERSINK
- A4200-0112 EXTRACTION SCREW HEXAGONAL 2,5 MM CONICAL
- A4200-0113 PERIOSTEAL ELEVATOR 12 MM
- A4200-0114 HOLLOW REAMER Ø6,0
- A4200-0115 TAP CORTEX 3,5 MM
- A4200-0116 SILICON HANDLE SCREWDRIVER HEXAGONAL 2,5 MM
- A4200-0117 SELF-CENTERING BONE HOLDING FORCEPS (190 MM)
- A4200-0118 SHARP REDUCTION FORCEPS (190 MM)
- A4200-0119 OBLIQUE REDUCTION FORCEPS (170 MM)
- A4200-0120 BENDING IRON
- A4200-0121 ALUMINIUM BOX

## Large Fragment Instrument Set

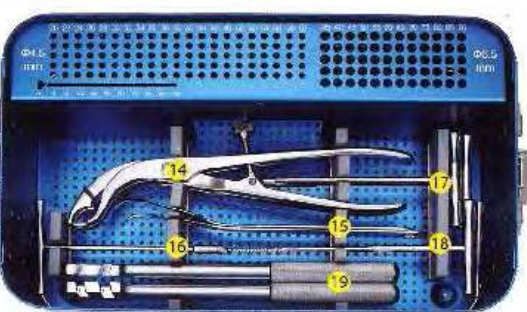
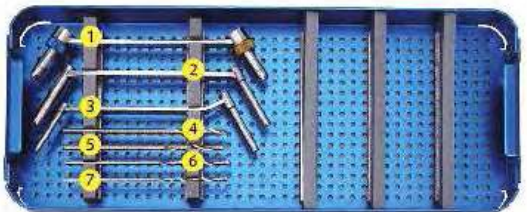

- A4200-0200 LARGE FRAGMENT INSTRUMENT SET
- A4200-0201 NEUTRAL AND LOAD DRILL GUIDE Ø3,2
- A4200-0202 DRILL & TAP GUIDE (Ø4,5/Ø6,5)
- A4200-0203 DRILL & TAP GUIDE (Ø3,2/Ø4,5)
- A4200-0204 DRILL BIT (Ø4,5\*115 MM)
- A4200-0205 DRILL BIT (Ø4,5\*115 MM)
- A4200-0206 DRILL BIT (Ø3,2\*115 MM)
- A4200-0207 DRILL BIT (Ø3,2\*115 MM)
- A4200-0208 DEPTH GAUGE (0-90 MM)
- A4200-0209 PERIOSTEAL ELEVATOR 15 MM
- A4200-0210 OBLIQUE REDUCTION FORCEPS (230 MM)
- A4200-0211 PERIOSTEAL ELEVATOR 8 MM
- A4200-0212 SHARP REDUCTION FORCEPS (200 MM)
- A4200-0213 SILICON HANDLE SCREWDRIVER HEXAGONAL 3,5 MM
- A4200-0214 SELF-CENTERING BONE HOLDING FORCEPS (270 MM)
- A4200-0215 RETRACTOR WIDTH 40 MM/18 MM
- A4200-0216 COUNTERSINK Ø8,0
- A4200-0217 HOLLOW REAMER Ø8,0
- A4200-0218 EXTRACTION SCREW HEXAGONAL 3,5 MM CONICAL
- A4200-0219 TAP CORTEX 4,5 MM
- A4200-0220 TAP CANCELLOUS 6,5 MM
- A4200-0221 BENDING IRON
- A4200-0222 ALUMINIUM BOX

## Micro Plate Instrument Set

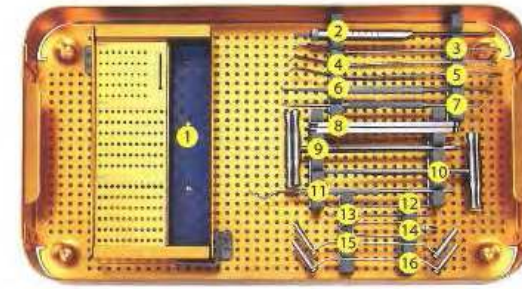

- A4200-0300 MICRO PLATE INSTRUMENT SET
- A4200-0301 SCREW BOX(1,5/2,0/2,7 MM)
- A4200-0302 DEPTH GAUGE(0-40 MM)
- A4200-0303 BONE ELEVATOR LARGE
- A4200-0304 BONE ELEVATOR MEDIUM
- A4200-0305 BONE ELEVATOR SMALL
- A4200-0306 DISSECTOR 5 MM
- A4200-0307 DISSECTOR 3 MM
- A4200-0308 BENDING IRON
- A4200-0309 COUNTERSINK HA2,7
- A4200-0310 COUNTERSINK HA2,0
- A4200-0311 TAP HA2,0
- A4200-0312 TAP HA2,7
- A4200-0313 SHARP HOOK
- A4200-0314 DRILL BIT (Ø1,5)
- A4200-0315 DRILL BIT (Ø2,0)
- A4200-0316 SCREW FORCEPS
- A4200-0317 GUIDE(Ø2,0/Ø2,7)
- A4200-0318 GUIDE(Ø1,5/Ø2,0)
- A4200-0319 PLATE-BENDING FORCEPS
- A4200-0320 WIRE CUTTER
- A4200-0321 BONE RIBBING RONGEUR
- A4200-0322 POINTED-TIP REDUCTION FORCEPS
- A4200-0323 BENT-TIP REDUCTION FORCEPS
- A4200-0324 PLATE-HOLD FORCEPS
- A4200-0325 HEXAGONAL SCREWDRIVER SW2,0
- A4200-0326 SKIN RETRACTOR
- A4200-0327 ALUMINIUM BOX

## Mini Fragment Instrument Set

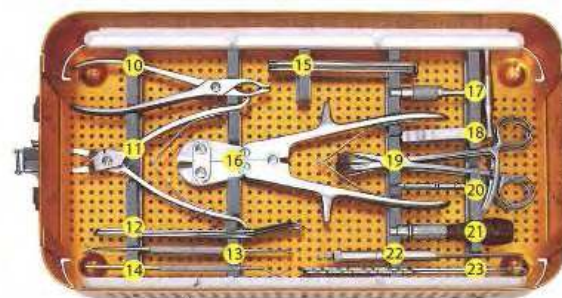
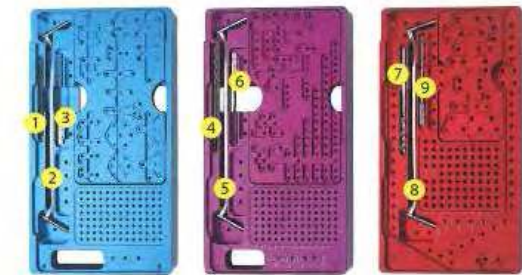

- A4200-0400 MINI FRAGMENT INSTRUMENT SET
- A4200-0401 TAP HA 1,5
- A4200-0402 GUIDE 1,1/1,5
- A4200-0403 DRILL BIT 1,1\*80 MM
- A4200-0404 TAP HA2,0
- A4200-0405 GUIDE 1,5/2,0
- A4200-0406 DRILL BIT 1,5\*80 MM
- A4200-0407 TAP HA2,7
- A4200-0408 GUIDE 2,0/2,7
- A4200-0409 DRILL BIT 2,0\*80 MM
- A4200-0410 PLATE-HOLDING FORCEPS
- A4200-0411 PLATE-BENDING FORCEPS
- A4200-0412 RETRACTORS 1\*3
- A4200-0413 DISSECTOR 5MM
- A4200-0414 DISSECTOR 3MM
- A4200-0415 SHARP HOOK
- A4200-0416 BENDING IRON
- A4200-0417 WIRE CUTTER
- A4200-0418 T-HANDLE QUICK COUPLING
- A4200-0419 SCREW FORCEPS
- A4200-0420 POINTED-TIP REDUCTION FORCEPS
- A4200-0421 BENT-TIP REDUCTION FORCEPS
- A4200-0422 SHAPE-MADE FORCEPS
- A4200-0423 QUICK COUPLING SCREWDRIVER HEXAGONAL (SW2,0)
- A4200-0424 COUNTERSINK
- A4200-0425 DEPTH GAUGE 0-40MM
- A4200-0426 SKIN RETRACTOR
- A4200-0427 ALUMINIUM BOX

Rib Plate Instrument Set

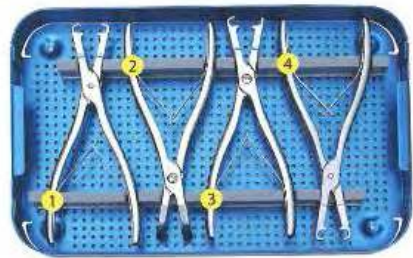

- A4200-0900 RIB PLATE INSTRUMENT SET
- A4200-0901 REDUCTION FORCEPS DOUBLE LARGE
- A4200-0902 REDUCTION FORCEPS CURVED
- A4200-0903 REDUCTION FORCEPS DOUBLE SMALL
- A4200-0904 REDUCTION FORCEPS SINGLE
- A4200-0905 PLATE INSERT FORCEPS
- A4200-0906 RIB PLATE CUTTER
- A4200-0907 PERIOSTEAL ELEVATOR 9 MM
- A4200-0908 PERIOSTEAL ELEVATOR 12 MM
- A4200-0909 ALUMINIUM BOX

1,5/2,0 mm Maxillofacial Plate Instrument Set



1,5/2,0mm Maxillofacial Plate Cutter & Bender L 3128-0123  
1,5/2,0mm Maxillofacial Plate Cutter & Bender R 3128-0122

- A3128-0100 1,5/2,0mm MAXILLOFACIAL PLATE INSTRUMENT SET
- A3128-0101 HOLLOW REAMER 1,5 MM
- A3128-0102 HOLLOW REAMER 2,0 MM
- A3128-0103 SCREWDRIVER FOR 1,5 MM SCREW
- A3128-0104 SCREWDRIVER FOR 2,0 MM SCREW
- A3128-0105 SCREWDRIVER FOR 2,0 MM SCREW
- A3128-0106 LIMITED DRILL BIT 1,6\*5 MM
- A3128-0107 LIMITED DRILL BIT 1,6\*6 MM
- A3128-0108 LIMITED DRILL BIT 1,6\*7 MM
- A3128-0109 LIMITED DRILL BIT 1,6\*9 MM
- A3128-0110 LIMITED DRILL BIT 1,6\*11MM
- A3128-0111 LIMITED DRILL BIT 1,6\*13 MM
- A3128-0112 LIMITED DRILL BIT 1,6\*15 MM
- A3128-0113 LIMITED DRILL BIT 1,1\*4 MM
- A3128-0114 LIMITED DRILL BIT 1,1\*5 MM
- A3128-0115 LIMITED DRILL BIT 1,1\*6 MM
- A3128-0116 LIMITED DRILL BIT 1,1\*7 MM
- A3128-0117 LIMITED DRILL BIT 1,1\*9 MM
- A3128-0118 LIMITED DRILL BIT 1,1\*11 MM
- A3128-0119 QUICK COUPLING HANDLE
- A3128-0120 GUIDE 1,1 MM & 1,6 MM
- A3128-0121 ALUMINIUM BOX

2,4 mm Maxillofacial Plate Instrument Set

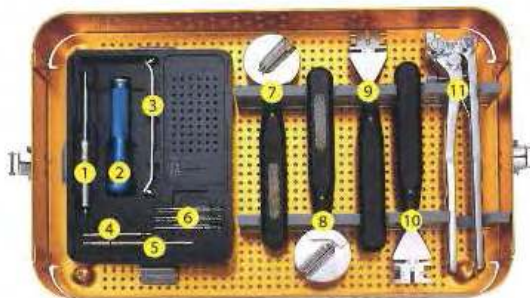

- A3128-0200 2,4 MAXILLOFACIAL PLATE INSTRUMENT SET
- A3128-0201 DEPTH GAUGE 0-30 MM
- A3128-0202 QUICK COUPLING HANDLE
- A3128-0203 GUIDE 1,9 MM
- A3128-0204 COUNTERSINK DRILL 2,0 MM
- A3128-0205 SCREWDRIVER FOR 2,4 MM SCREW
- A3128-0206 LIMITED DRILL BIT 1,9\*5 MM
- A3128-0207 LIMITED DRILL BIT 1,9\*7 MM
- A3128-0208 LIMITED DRILL BIT 1,9\*9 MM
- A3128-0209 LIMITED DRILL BIT 1,9\*11 MM
- A3128-0210 LIMITED DRILL BIT 1,9\*13 MM
- A3128-0211 LIMITED DRILL BIT 1,9\*15 MM
- A3128-0212 PLATE SHAPING FORCEPS ROUND
- A3128-0213 PLATE SHAPING FORCEPS ROUND
- A3128-0214 PLATE BENDER
- A3128-0215 PLATE BENDER
- A3128-0216 PLATE SHAPING FORCEPS
- A3128-0217 ALUMINIUM BOX

Intramedullary Nail Removal Instrument Set

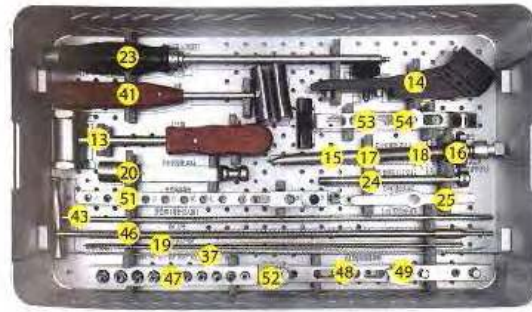
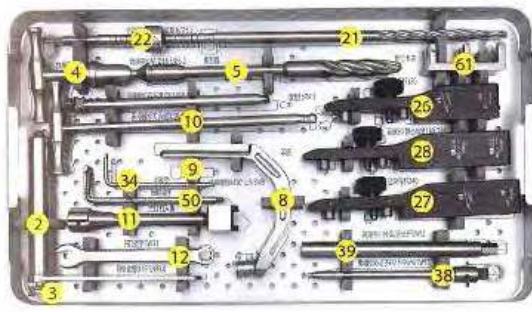
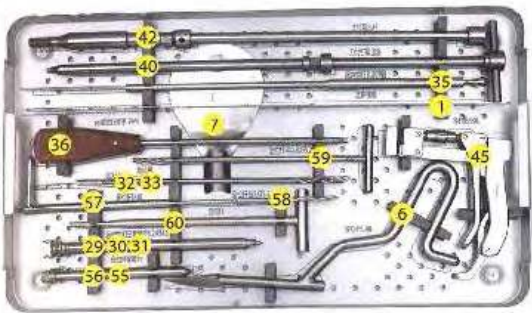

- A1200-1200 INTRAMEDULLARY NAIL REMOVAL INSTRUMENT SET
- 1200-1201 T-HANDLE QUICK COUPLING
- 1200-1202 WRENCH
- 1200-1203 OPEN WRENCH T1,5
- 1200-1204 END CAP WRENCH 180 MM
- 1200-1205 LOCKING SCREW EXTRACTOR 250 MM
- 1200-1206 HEXAGONAL SCREWDRIVER SW2,5\*250 MM
- 1200-1207 HEXAGONAL SCREWDRIVER SW3,5\*250 MM
- 1200-1208 HEXAGONAL SCREWDRIVER SW4,0\*250 MM
- 1200-1209 HEXAGONAL SCREWDRIVER SW4,5\*250 MM
- 1200-1210 HEXAGONAL SCREWDRIVER SW5,0\*250 MM
- 1200-1211 WIRE CUTTER
- 1200-1212 SAW BLADE EXTRACTOR CHUCK SW4,0 RIGHT/LEFT
- 1200-1213 EXTRACTOR CHUCK M8\*1 MM
- 1200-1214 EXTRACTOR CHUCK M8
- 1200-1215 EXTRACTOR CHUCK M10
- 1200-1216 EXTRACTOR CHUCK M10\*1MM\*
- 1200-1217 EXTRACTOR CHUCK UNIVERSAL LARGE
- 1200-1218 EXTRACTOR CHUCK M11
- 1200-1219 EXTRACTOR CHUCK M6
- 1200-1220 EXTRACTOR CHUCK UNIVERSAL SMALL
- 1200-1221 HAMMER
- 1200-1222 SAW BLADE DRIVER
- 1200-1223 UNIVERSAL JOINT
- 1200-1224 ALUMINIUM BOX

### 4,0 mm Cannulated Screw Instrument Set

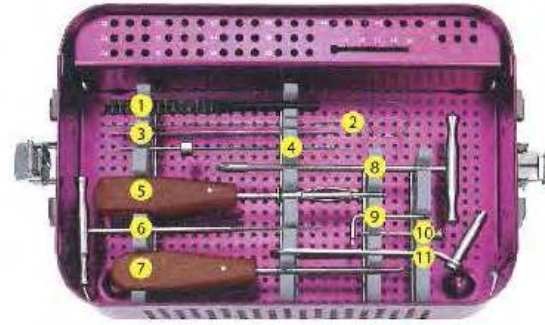

- A4200-0600 4,0 MM CANNULATED SCREW INSTRUMENT SET
- A4200-0601 DEPTH GAUGE (0-80 MM)
- A4200-0602 CLEANING STYLET 1,2 MM
- A4200-0603 THREADED GUIDE WIRE 1,2 MM
- A4200-0604 CANNULATED DRILL BIT WITH LIMITED BLOCK 2,7 MM
- A4200-0605 SCREWDRIVER HEXAGONAL 2,5 MM
- A4200-0606 CANNULATED TAP CANNULATED SCREW 4,0 MM
- A4200-0607 CANNULATED SCREWDRIVER HEXAGONAL 2,5 MM
- A4200-0608 CANNULATED COUNTERSINK Ø6,5
- A4200-0609 HEXAGONAL KEY
- A4200-0610 DRILL SLEEVE 1,2 MM
- A4200-0611 PROTECTION SLEEVE
- A4200-0612 ALUMINIUM BOX

### 6,5 mm Cannulated Screw Instrument Set

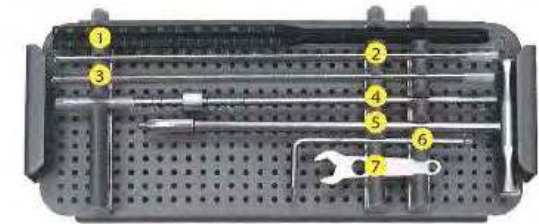

- A4200-0700 6,5 MM CANNULATED SCREW INSTRUMENT SET
- A4200-0701 DEPTH GAUGE (0-120 MM)
- A4200-0702 THREADED GUIDE WIRE 2,5 MM
- A4200-0703 THREADED GUIDE WIRE 2,5 MM
- A4200-0704 CANNULATED DRILL BIT WITH LIMITED BLOCK 4,5 MM
- A4200-0705 CANNULATED COUNTERSINK Ø9
- A4200-0706 HEXAGONAL KEY
- A4200-0707 WRENCH FOR ADJUSTABLE PARALLEL WIRE GUIDE
- A4200-0708 MULTIPLE WIRE GUIDE
- A4200-0709 TAP CANNULATED SCREW 6,5 MM
- A4200-0710 SCREWDRIVER HEXAGONAL 3,5 MM
- A4200-0711 CLEANING STYLET 2,5 MM
- A4200-0712 DRILL SLEEVE
- A4200-0713 ADJUSTABLE PARALLEL WIRE GUIDE
- A4200-0714 CANNULATED SCREWDRIVER HEXAGONAL 3,5 MM
- A4200-0715 ALUMINIUM BOX

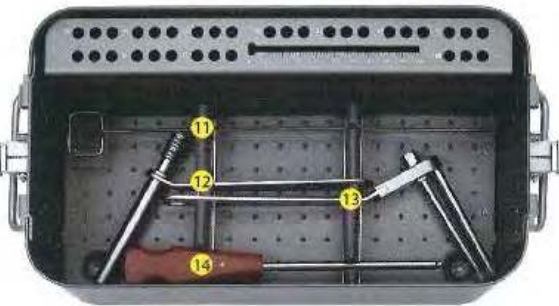

### DHS/DCS Plate Instrument Set

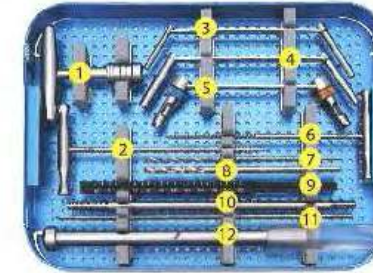
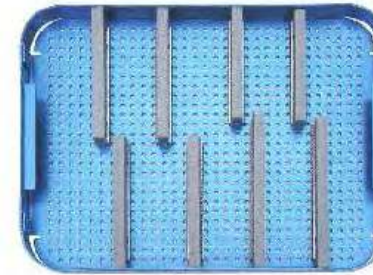

- A4200-0500 DHS & DCS INSTRUMENT SET
- A4200-0501 T-HANDLE QUICK COUPLING
- A4200-0502 TAP CORTICAL 4,5 MM
- A4200-0503 DOUBLE DRILL SLEEVE (Ø4,5/Ø6,5)
- A4200-0504 DOUBLE DRILL SLEEVE (Ø4,5/Ø3,2)
- A4200-0505 NEUTRAL AND LOAD DRILL GUIDE Ø2,5
- A4200-0506 TAP CANCELLOUS 6,5 MM
- A4200-0507 DRILL BIT Ø4,5\*150 MM
- A4200-0508 DRILL BIT Ø3,5\*150 MM
- A4200-0509 LAG SCREW DEPTH MEASURING DEVICE
- A4200-0510 TAP CANCELLOUS 12 MM
- A4200-0511 THREADED K-WIRE Ø2,5\*225 MM
- A4200-0512 DHS/DCS IMPACTOR LARGE
- A4200-0513 DEPTH GAUGE(0-100 MM)
- A4200-0514 DHS/DCS IMPACTOR SMALL
- A4200-0515 DHS/DCS WRENCH,PURPLE SLEEVE
- A4200-0516 DHS/DCS WRENCH,GOLDEN SLEEVE
- A4200-0517 SCREWDRIVER HEXAGONAL 3,5 MM
- A4200-0518 DCS ANGLE GUIDE 95 DEGREE
- A4200-0519 DHS ANGLE GUIDE 135 DEGREE
- A4200-0520 DHS REAMER
- A4200-0521 DCS REAMER
- A4200-0522 ALUMINIUM BOX
- A4200-0523 THREADED DRILL GUIDE(SLEEVE) 4,3 MM
- A4200-0524 THREADED DRILL GUIDE(SLEEVE) 4,3 MM
- A4200-0525 THREADED DRILL GUIDE(SLEEVE) 4,3 MM

### Pelvic Reconsruction Plate Instrument Set

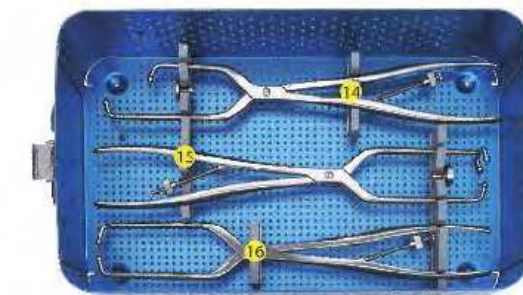
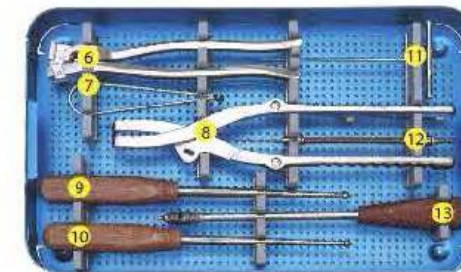
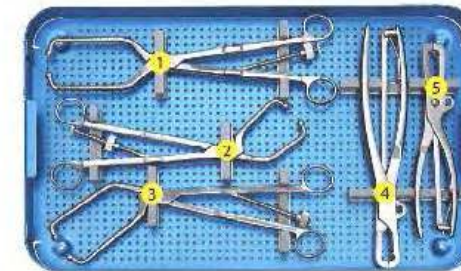

- A4200-0802 PELVIC REDUCTION FORCEP 280 MM
- A4200-0803 ANGLED PELVIC REDUCTION FORCEP 250 MM
- A4200-0804 ANGLED PELVIC REDUCTION FORCEP 280 MM
- A4200-0805 PELVIC REDUCTION FORCEP MEDIUM 250 MM
- A4200-0806 PELVIC REDUCTION FORCEP SMALL 200 MM
- A4200-0807 PLATE BLANDER
- A4200-0808 DRILL GUIDER 2,5 FOR FOEXIBLE DRILL BIT
- A4200-0809 PELVIC REDUCTION FORCEP LARGE 330 MM
- A4200-0810 STRIGHT BALL SPIKE 300 MM
- A4200-0811 TOP COTEX 3,5 MM
- A4200-0812 FEXIBLE DRILL BIT Ø2,5
- A4200-0813 UNIVERSAL SCREWDRIVER HEXAGONAL 2,5 MM
- A4200-0814 PELVIC ASYMMETRIC REDUCTION FORCEP WITH SPIKED DISC ROUND CURVED/FLAT
- A4200-0815 PELVIC ASYMMETRIC REDUCTION FORCEP 400 MM
- A4200-0816 PELVIC ASYMMETRIC REDUCTION FORCEP WITH 3 BALL-TIPED
- A4200-0817 ALUMINIUM BOX

## Herbert Cannulated Screw Instrument Set

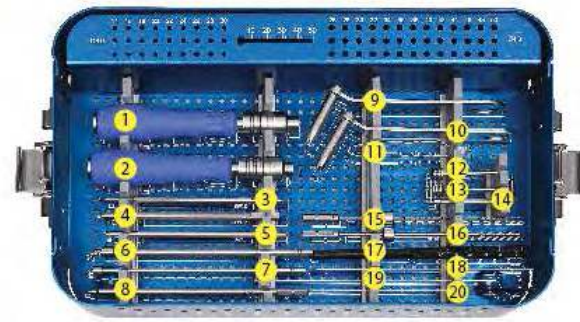

- A4200-1500011 Cannulated Tap, 4.5mm 1
- A4200-11012 Cannulated Screwdriver, 4.5mm 1
- A4200-11013 Trephine, 4.5mm 1
- A4200-11014 Pilot Drill Bit, 3.8mm 1
- A4200-11015 Main Drill Bit, 3.1mm 1
- A4200-11016 Guide Pin, Partially Threaded, 1.6mm 1
- A4200-11021 Cannulated Tap, 6.5mm 1
- A4200-11022 Cannulated Screwdriver, 6.5mm 1
- A4200-11023 Trephine 1
- A4200-11024 Pilot Drill Bit, 5.5mm 1
- A4200-11026 Guide Pin, Partially Threaded, 2.0mm 1
- A4200-11027 Main Drill Bit, 4.6mm 1
- A4200-1180-040 Depth Guide 1
- A4200-4808-020 Parallel Drill Guide, 2.0mm 1
- A4200-11085 Sterilization Tray 1

## Headless Cannulated Screw Set



- A4200-13-1 4.5 mm Headless Compression Screw Graphic Case
- A4200-13-2 Screw Rack for 4.5 mm Headless Compression Screws
- A4200-13-3 Measuring Device, for 4.5 mm Headless Compression Screws
- A4200-13-4 Compression Sleeve, for 4.5 mm Headless Compression Screws
- A4200-13-5 Sleeve for Compression Sleeve Handle, for 4.5 mm Headless Compression Screws
- A4200-13-6 Headless Compression Screws
- A4200-13-7 Compression Sleeve Attachment, for 4.5 mm Headless Compression Screws
- A4200-13-8 3.2 mm Cannulated Drill Bit
- A4200-13-9 Cannulated Tap
- A4200-13-10 Cannulated StarDrive Screwdriver, T15
- A4200-13-11 4.0 mm Cannulated Drill Bit
- A4200-13-12 T-Handle, with quick coupling
- A4200-13-13 1.6 mm Trocar
- A4200-13-14 3.2 mm/1.6 mm Drill Sleeve
- A4200-13-15 7.0 mm/3.2 mm Drill Sleeve
- A4200-13-16 9.5 mm/7.0 mm Protection Sleeve
- A4200-13-17 StarDrive Screwdriver Shaft, quick coupling, T15
- A4200-13-18 1.75 mm Cleaning Brush
- A4200-13-19 1.6 mm Cleaning Stylet

## Angled Blade Plate Instrument Set



- A4200-1600-1 Seating Chisel for Adult
- A4200-1600-2 Seating Chisel for Infants
- A4200-1600-3 Seating Chisel for Adolescent and children
- A4200-1600-4 Inserter - Extractor for Adolescent and Children
- A4200-1600-5 Inserter-Extractor for adults
- A4200-1600-6 Impactor for angular plates
- A4200-1600-7 Slotted Hammer
- A4200-1600-8 Chisel Guide
- A4200-1600-9 Traingular Positioning Plate 80/70/30
- A4200-1600-10 Chisel Guide
- A4200-1600-12 Traingular Positioning Plate 90/50/40
- A4200-1600-13 Quadrangular Positioning Plate 110/90/90/70
- A4200-1600-14 Quadrangular Positioning Plate 100/60/20

## Ayfix External Fixator Instrument Set



- A5200-0100 Trocar
- A5200-0100 Hexagonal Wrench 6.0 mm
- A5200-0100 Hexagonal Wrench 4.0 mm
- A5200-0100 Hexagonal Wrench 5.0 mm
- A5200-0100 Sleeve Guide
- A5200-0100 Drill Guide
- A5200-0100 Drill Guide and Sleeve Guide
- A5200-0100 T-Wrench (Quick Coupling Drill)
- A5200-0100 Wrench
- A5200-0100 T-Handle with Jacob's Chuck
- A5200-0100 T-Handle Shaft
- A5200-0100 T-Handle Adapter 4.0 /5.0/6.0 mm
- A5200-0100 Two Side Open Wrench
- A5200-0100 Single Side Open Wrench
- A5200-0100 One Side Open One Side Circular Wrench
- A5200-0100 Drill Bit with Stopper
- A5200-0100 Long Bone Drill

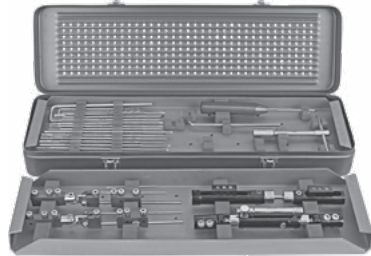

## Mini Rail Instrument Set



- A5200-0100 T-Wrench for bone screw
- A5200-0100 Threaded wire Ø1,6 mm (pack of 4) total length 40 mm, thread length 15 mm
- A5200-0100 Threaded wire Ø2,0 mm (pack of 4) total length 45 mm, thread length 20 mm
- A5200-0100 Threaded wire extractor
- A5200-0100 Allen wrench 3 mm
- A5200-0100 T-wrench for clamp screws
- A5200-0100 Drill Sleeve 2,0/2,5 mm
- A5200-0100 Bone Drill 1,6/2,0 mm

## Tubular Fixator Instrument Set



- A5200-0300 Hoffmann External Fixation Small
- A5200-0300 Fragment Set
- A5200-0300 Rod-Rod Coupling (5mm Rod) 12
- A5200-0300 Rod-Pin Coupling (3/4mm Pin, 5mm Rod) 12
- A5200-0300 Hole Pin Clamp (3/4mm Pin) 3
- A5200-0300 Pin Clamp (3/4mm Pin) 1
- A5200-0300 Straight Post 2
- A5200-0300 Degree Angled Post 4
- A5200-0300 Apex Pin Self-drilling 3\*80mm 4
- A5200-0300 Apex Pin Self-drilling 3\*100mm 4
- A5200-0300 Apex Pin Self-drilling 4\*80mm 4
- A5200-0300 Apex Pin Self-drilling 4\*100mm 4
- A5200-0300 Apex Pin Self-drilling 4\*120mm 4
- A5200-0300 Drill Sleeve 3mm 1
- A5200-0300 Drill Sleeve 4mm 1
- A5200-0300 Carbon Fiber Connecting Rod 5\*120mm 4
- A5200-0300 Carbon Fiber Connecting Rod 5\*150mm 4
- A5200-0300 Carbon Fiber Connecting Rod 5\*180mm 2
- A5200-0300 Carbon Fiber Connecting Rod 5\*200mm 4
- A5200-0300 T-shaped Clamp Wrench 5# 1
- A5200-0300 Reduction Wrench 1
- A5200-0300 Elbow Joint 5mm 1
- A5200-0300 Apex Pin Chuck 3mm 1
- A5200-0300 Apex Pin Chuck 4mm 1
- A5200-0300 T-shaped Pin Wrench 3mm 1
- A5200-0300 T-shaped Pin Wrench 4mm 1
- A5200-0300 Arc Drilling Stand 1
- A5200-0300 Adjust Wheel 1
- A5200-0300 Aluminum Box 1

## Hybrid Fixator Instrument Set

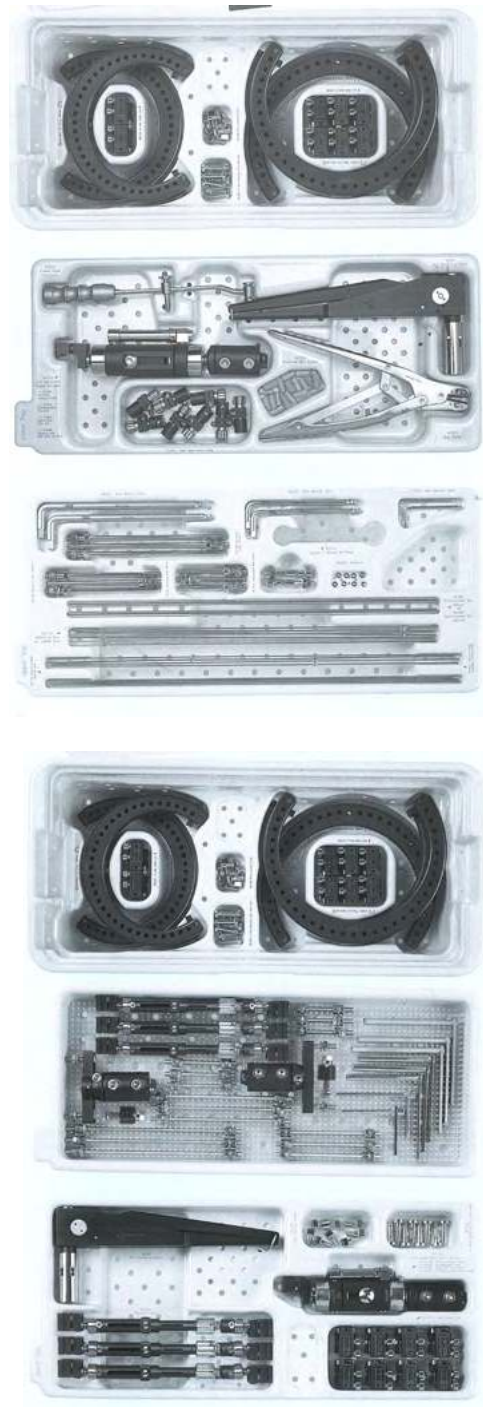

- A5200-0400 2x30017Two-Hole X-Wire Securing Pin Three-Hole Wire Clamp
- A5200-0400 Slider Unit
- A5200-0400 Wire Guide Wire Tensioner
- A5200-0400 Hybrid Fixator Standard Assembly Kit
- A5200-0400 Consisting of: 7 ProCallus Standard Central Body, Compression-Distractor Unit Standard; 7 ProCallus Straight Clamp;
- A5200-0400 Hybrid Coupling with Ball-Joint. Wire Cutter
- A5200-0400 Supplementary Screw Holder Clamp
- A5200-0400 X-Wire Covers (pack of 20)
- A5200-0400 Allen Wrench 6 mm Allen Wrench 5 mm
- A5200-0400 RadioLucent Rings (see p. 36)
- A5200-0400 Lower Tray (Generic)
- A5200-0400 2x80035 Sheffield Clamp
- A5200-0400 2x80074 Single Screw Clamp
- A5200-0400 3x80047 Reduction Unit
- A5200-0400 3x11137 Screw Guide, length 80 mm
- A5200-0400 3x 11103 Screw Guide, length 100 mm
- A5200-0400 1x 11105 Drill Guide 0 4.8 mm, length 80 mm
- A5200-0400 1x 11138 Drill Guide 0 4.8 mm, length 60 mm
- A5200-0400 1x80034 Bolts 60 mm (set of 3)
- A5200-0400 1x80036 Threaded Bars,length 80 mm (set of 3)
- A5200-0400 1x80037 Threaded Bars,length 120 mm (set of 3)
- A5200-0400 1x80038 Threaded Bars,length 160 mm (set of 3)
- A5200-0400 1x80039 Threaded Bars,length 200 mm (set of 3)
- A5200-0400 Upper Tray
- A5200-0400 Allen Wrench 3 mm Independent Wire Clamp Post, length 50 mm
- A5200-0400 Post, length 100 mm Post, length 150 mm
- A5200-0400 F.F.S. Large Washers (pack of 4) Supplementary Screw Holder Bar 0 6 mm,
- A5200-0400 Wire Tensioner
- A5200-0400 Ring Locking Screw
- A5200-0400 Two-Hole X-Wire Securing Pin Hybrid Fixator Short Assembly Kit
- A5200-0400 Consisting of:- 7 ProCallus Straight Clamp, ProCallus Short Central Body, 7 Compression
- A5200-0400 Supplementary Screw Holder Bar 0 6 mm, length 400 mm X-Wire with lateral olive
- A5200-0400 2 mm, length 400 mm X-Wire with central olive 0 2 mm, length 400 mm X-Wire with central olive 0 2 mm, length 450 mm X-Wire without olive
- A5200-0400 2 mm, length 400 mm X-Wire without olive
- A5200-0400 2 mm, length 450 mm

## Circular External Fixator (Adult) Instrument Set

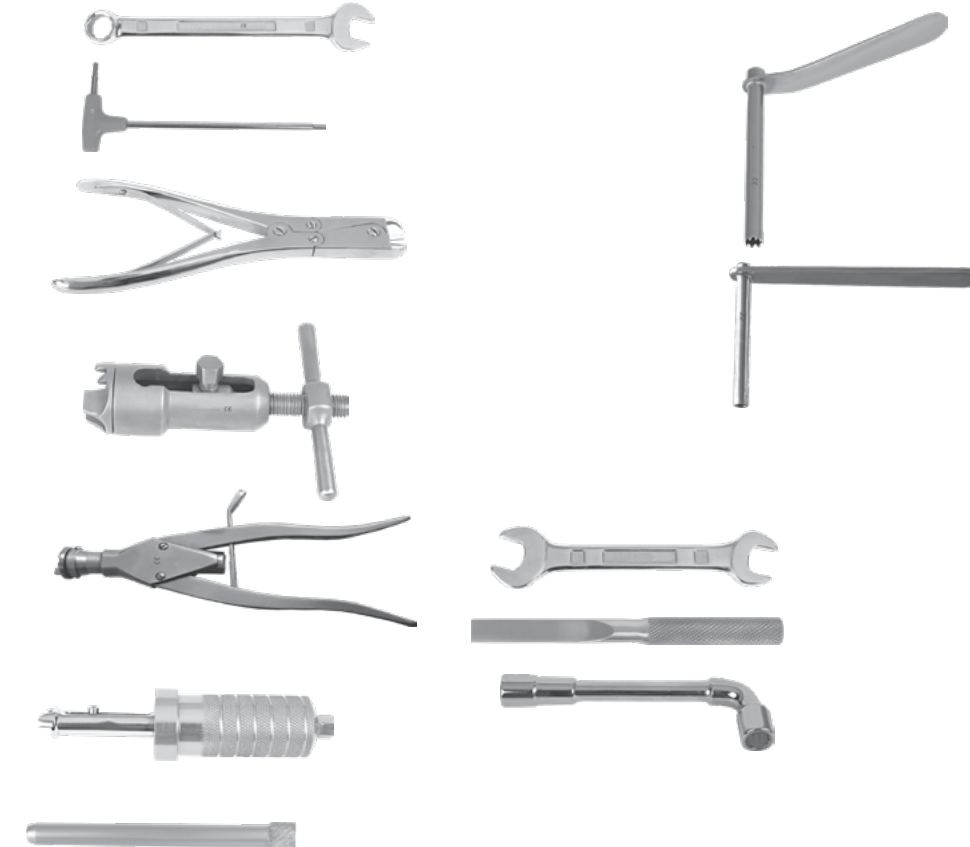

- A5200-0500 Hybrid External Fixator (For Adaptation to External Circular Fixation System)
- A5200-0500 T-Wrench
- A5200-0500 Wrench with Open-Circular Ends
- A5200-0500 Hexagonal Wrench
- A5200-0500 Wrench with two Open Ends
- A5200-0500 Osteotome
- A5200-0500 Wire Cutter
- A5200-0500 Double Ended Offset Socket Wrench
- A5200-0500 Wire Tensioner
- A5200-0500 Wire Tightener
- A5200-0500 Sleeve Guide
- A5200-0500 Wire Tensioner
- A5200-0500 Drill Guide
- A5200-0500 Drill Guide without Handle
- A5200-0500 Adjustable Wrench
- A5200-0500 Adjustable Wrench End Piece

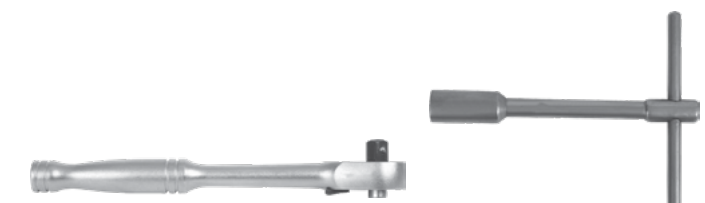

## Circular External Fixator (Pediatric) Instrument Set

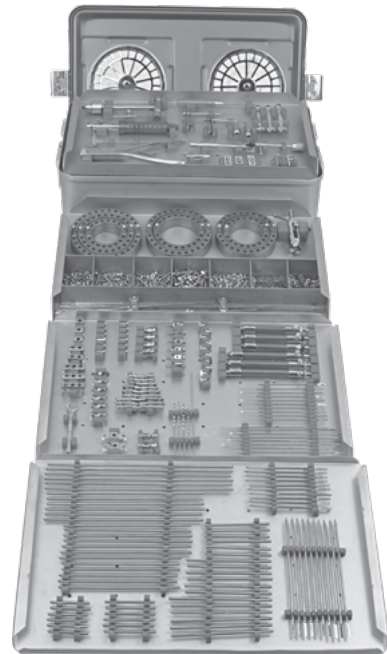

- A5200-0600 Hybrid External Fixator (For Adaptation to External Circular Fixation System)
- A5200-0600 T-Wrench
- A5200-0600 Wrench with Open-Circular Ends
- A5200-0600 Hexagonal Wrench
- A5200-0600 Wrench with two Open Ends
- A5200-0600 Osteotome
- A5200-0600 Wire Cutter
- A5200-0600 Double Ended Offset Socket 7100-0020-009 Wrench
- A5200-0600 Wire Tensioner
- A5200-0600 Wire Tightener
- A5200-0600 Sleeve Guide
- A5200-0600 Wire Tensioner
- A5200-0600 Drill Guide
- A5200-0600 Drill Guide without Handle
- A5200-0600 Adjustable Wrench
- A5200-0600 Adjustable Wrench End Piece

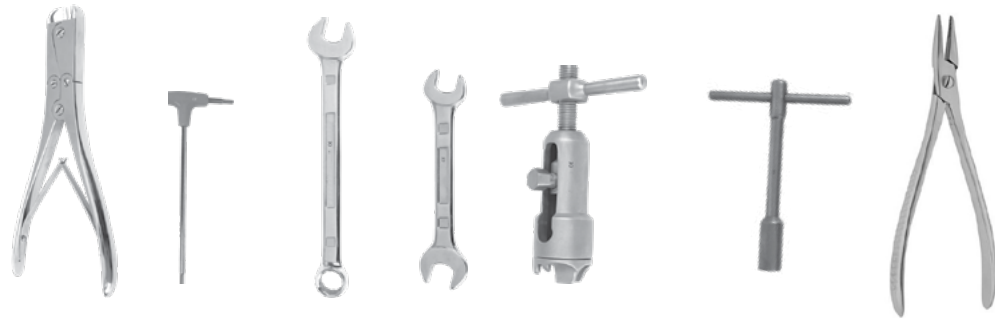

## Wire Pin Instrument Set



- A6200-0100 Drill Guide
- A6200-0100 391.885 x1--Forceps
- A6200-0100 Depth Gauge
- A6200-0100 Plier
- A6200-0100 Screw driver



## Cable-crim Block Instrument Set

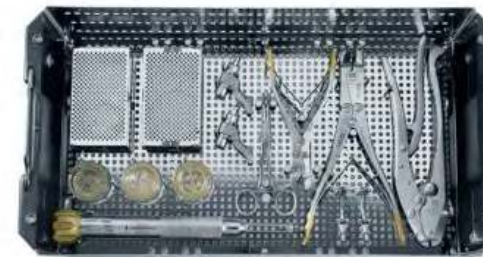

- A4200-1700 Sterilization Case
- A4200-1700 Attachment Bits
- A4200-1700 Cable Tensioner
- A4200-1700 Medium Cable Passer-Curved
- A4200-1700 Large Cable Passer-Curved
- A4200-1700 Large Cable Passer
- A4200-1700 Large Cable Passer-45°
- A4200-1700 Medium cable Passer
- A4200-1700 Forceps
- A4200-1700 Provisional Tensioning Devices
- A4200-1700 Cable Tensioner
- A4200-1700 Cable Crimper
- A4200-1700 Cable Cutter-Large
- A4200-1700 Cable Cutter-Standard

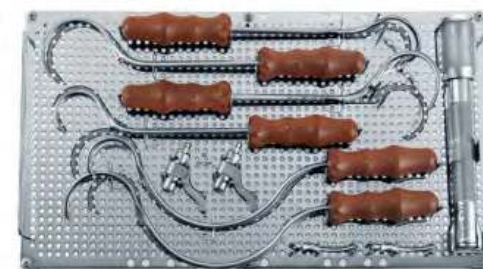



**Aysam İstanbul**

Molla Gürani Mah. Molla Gürani Cad. No:59/9 Fındıkzade/Fatih  
0 212 531 12 00  
istanbul@aysam.com.tr

**Aysam Samsun**

Ulugazi Mah. İstiklal Cad. No: 28/5 SAMSUN  
Tel: +90 362 435 37 72 - Fax: +90 362 420 02 94  
info@aysam.com.tr

**Aysam Workshop**

Organize Sanayi Sitesi M.Erdoğan Cebeci Bulv. No: 34 Kutlukent / SAMSUN  
Tel: +90 362 266 69 70  
fabrika@aysam.com.tr

**Aysam Warehouse**

Örnek Sanayi Sitesi 34. Sokak No: 10 Kutlukent / SAMSUN  
depo@aysam.com.tr

[www.aysam.com.tr](http://www.aysam.com.tr)

[aysam@aysam.com.tr](mailto:aysam@aysam.com.tr)