

5009

PRODUCT RANGE

wire pins... mini plates & screws... angled plates... cannulated screws... headless screws... locking plates... intramedullary nails... spinal systems... dhs/dcs plates... elastic nails... locking plates... locking screws... external fixators... angled plates... trochanteric plates

quality & trust

Implant Catalog

www.aysam.com.tr





**“We supply WORLD’s
Orthopedic & Trauma
Implants...”**





Implant Products

We continue to add new products to our 5009 trauma products

01

SMALL/LARGE FRAGMENT LOCKING/NON LOCKING PLATES & SCREWS

These products, components, treatment kits and tools are manufactured with medical interventions for the treatment of patients.

02

FEMUR/HUMERUS/TIBIA INTRAMEDULLARY NAILS

All nail implants, according to the type, model, size (details are given in Aysam catalog) are used in the treatment of bone fractures, congenital or later acquired disorders of skeletal system. Surgeons select the right type, size of implants according to conditions of patients.

03

POSTERIOR SPINAL SYSTEMS, CERVICAL PLATES & SCREWS

All Spinal System implants; type, model, size (details are given on Aysam catalog) and according to the surgeon's choice are used in the treatment of bone fractures, congenital or later acquired orthopedic, traumatological disorders of spinal column.

04

AYFIX DYNAMIC AXIAL, MINI RAIL, TUBULAR, HYBRID, CIRCULAR EXTERNAL FIXATORS

External fixator implants and components are used for treatment of Orthopedic & Traumatologic disorders for fixation, distraction & compression purposes of different bones & joints in human body.

05

WIRES, PINS, STAPLES & DRILL BITS

The wire-pin implants are designed and implemented to perform bone fixation in fractures. Fixation in corrective osteotomies, pseudoarthroses, arthrodesis, joint dislocations, replantation treatments, bone reconstructive & skeletal traction procedures. All type, model, size of implants are detailed in Aysam catalog.

OUR VISION IS TO BE THE LEADING COMPANY WORLD WIDE IN ORTHOPAEDIC TRAUMA WITH SUSTAINABLE GROWTH, BY FOLLOWING “CONTINUOUS IMPROVEMENT” AND “QUALITY IS IN DETAILS” PRINCIPLE.

Aysam has adopted the Total Quality Management System beginning from raw materials to the end of sales services. With this understanding it has certified its quality with certificates such as CE , ISO 9001 , ISO 13485.

Aysam aims to ensure the continuity of customer, patient and physician satisfaction in all conditions by educating and informing its staff at an advanced level in order to respond to requests from its customers faster and with higher quality. It increases it's individual and institutional quality by updating it with continuous trainings and seminars.

Aysam continues to add new products to its 17344 product range with R&D studies. It combines its 20 years of knowledge with modern technology and produces it's products in a more innovative and qualified way.



f aysam.orthopedics

t aysamortho

in aysam

YouTube aysam orthopaedics

Instagram aysamorthopaedics

With its customer feedbacks, R&D studies, specialist physicians, experienced engineers and modern infrastructure compatible with the requirements of the age, Aysam has adopted high quality, improved and innovative production as its principle.

With export to five continents for 20 years, Aysam is increasing its number of distributors day by day and advancing its goals with firm steps. Aysam continues its activities in full harmony and loyalty with its dealers and distributor companies & participates in the national, international fairs and congresses and introduces its products that it offers to the service of the Medical World.

Aysam is rapidly approaching its goals with its understanding of service that does not compromise on patient, physician and health personnel health, customer satisfaction and quality, and with its structure open to innovations.



QUALITY

We produce best quality products according to ISO 13485/MDD.

TRUST

We always support our customers and distributors in the market.

EXPERIENCE

Aysam has over 20 years experience on orthopaedic implant production.

INNOVATION

Innovation is our indispensable condition to move forward.

INDEX

SMALL FRAGMENT LOCKING & NON-LOCKING PLATES

- Small Fragment Locking Plates _____ 007
- Small Fragment Non-Locking Plates _____ 023

SMALL FRAGMENT LOCKING & NON-LOCKING SCREWS

- Small Fragment Locking Screws _____ 031
- Small Fragment Non-Locking Screws _____ 035

LARGE FRAGMENT LOCKING & NON-LOCKING PLATES

- Large Fragment Locking Plates _____ 039
- Large Fragment Non-Locking Plates _____ 054

DHS - DCS PLATES & LAG-COMPRESSION SCREWS

- DHS-DCS Plates _____ 063
- DHS-DCS Lag & Compression Screws _____ 066

LARGE FRAGMENT LOCKING & NON-LOCKING SCREWS

- Large Fragment Locking Screws _____ 067
- Large Fragment Non-Locking Screws _____ 073

MINI FRAGMENT LOCKING PLATES & SCREWS

- 1.5 mm Mini Fragment Locking Plates and Screws _____ 077
- 2.0 mm Mini Fragment Locking Plates and Screws _____ 080
- 2.4 mm Mini Fragment Locking Plates and Screws _____ 083
- 2.7 mm Mini Fragment Locking Plates and Screws _____ 085

CHEST WALL PLATES, SCREWS & SPLINTS

- Chest Wall Locking Plates _____ 89
- Chest Wall Locking Screws _____ 92
- Rib Intramedullary Splints _____ 92

ANGLED BLADE PLATES & PEDIATRIC PLATES

- Angled Blade Plates _____ 93
- Pediatric Locking Plates _____ 96
- Pediatric Eight Plates _____ 96

TROCHANTERIC PLATES & CABLE SYSTEMS

- Straight Cable Grip Plates _____ 97
- Trochanteric Cable Hook Plates _____ 98
- Trochanteric Cable Hook Grip Plates _____ 99
- Cable Locking Screws _____ 100
- Cable-Crimp Blocks _____ 100

CANNULATED SCREWS

- Cannulated Screws _____ 101

HEADLESS & HERBERT SCREWS

- Headless Screws _____ 109
- Herbert Screws _____ 111
- Interference Screws _____ 112

INTRAMEDULLARY NAILS

Humerus Intramedullary Nails

- Humerus Intramedullary Nails _____ 114

Femur Intramedullary Nails

- Femur Intramedullary Nails (ANTEGRADE) _____ 115
- Femur Intramedullary Nails (DFN/RETROGRADE) _____ 116
- Femur Short Reconstruction Intramedullary Nails (PFN) _____ 116
- Femur Long Reconstruction Intramedullary Nails _____ 117
- APFNA Femur Short Intramedullary Nails _____ 118
- AROCOM Proximal Femur Antirotation Compression Intramedullary Nails _____ 119
- ANTIRO Proximal Femur Antirotation Compression Intramedullary Nails _____ 121

Tibia Intramedullary Nails

- Tibia Intramedullary Nails _____ 123
- ANT Tibia Intramedullary Nails _____ 124

ELASTIC NAILS _____ 125

SPINAL SYSTEMS

- Posterior Spinal Systems _____ 127
- Cervical Plates & Screws _____ 132
- Anterior Thoracic-Lumbar Plates, Bolts & Screws _____ 134

EXTERNAL FIXATORS

- Ayfix Dynamic Axial External Fixators _____ 135
- Mini Rail External Fixators _____ 148
- Tubular External Fixators _____ 150
- Hybrid External Fixators _____ 154
- Circular External Fixators _____ 159
- Pediatric Circular External Fixators _____ 166

WIRES, PINS, STAPLES & DRILL BITS

- Kirschner Wires _____ 172
- Steinmann Pins _____ 173
- Schanz Screws _____ 174
- Rush Pins _____ 175
- Staples _____ 176
- Tibial Bolts _____ 177
- Knowless Hip Pins _____ 177
- Drill Bits _____ 178
- Gigli Saw _____ 178

"We supply WORLD's
Orthopedic & Trauma
Implants..."

Small Fragment Plates

Locking/Non-Locking



Small Fragment Locking Plates

3,5 mm Clavicle Locking Compression Plate



SS	TI	HOLES	SIDE	LENGTH (mm)
A1031906	A1031806	6	Left	70
A1031907	A1031807	7	Left	84
A1031908	A1031808	8	Left	98
A1031909	A1031809	9	Left	112
A1042906	A1042806	6	Right	70
A1042907	A1042807	7	Right	84
A1042908	A1042808	8	Right	98
A1042909	A1042809	9	Right	112

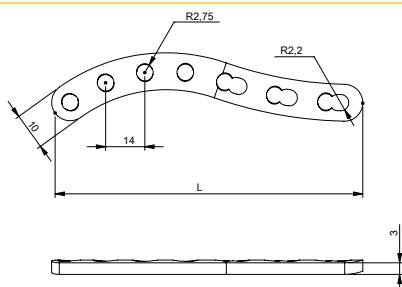

Intended use : Temporary fixation of fractures, malunions, nonunions, osteotomies and pseudoarthroses of the clavicle, particularly for patients with osteopenic bone.

3,5 mm Clavicle Hook Locking Plate



SS	TI	HOLES	SIDE	LENGTH (mm)
A26009141	A26009041	4	Left	63
A26009151	A26009051	5	Left	75
A26009161	A26009061	6	Left	86
A26009171	A26009071	7	Left	97
A26009142	A26009042	4	Right	63
A26009152	A26009052	5	Right	75
A26009162	A26009062	6	Right	86
A26009172	A26009072	7	Right	97

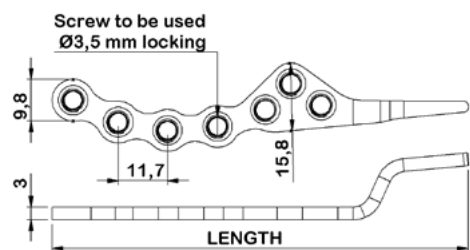

Intended use : Intended use: Temporary fixation of fractures, malunions, nonunions, osteotomies and pseudoarthroses of the clavicle, for the treatment of acromioclavicular dislocations, particularly for patients with osteopenic bone.

Small Fragment Locking Plates

2,7/3,5 mm Distal Clavicle Locking Compression Plate



SS	TI	HOLES	SIDE	LENGTH (mm)
A5521903	A1021803	3	Left	66,5
A5521904	A1021804	4	Left	78,7
A5521905	A1021805	5	Left	91,1
A5521906	A1021806	6	Left	103,2
A5521907	A1021807	7	Left	113,8
A5522903	A1022803	3	Right	66,5
A5522904	A1022804	4	Right	78,7
A5522905	A1022805	5	Right	91,1
A5522906	A1022806	6	Right	103,2
A5522907	A1022807	7	Right	113,8

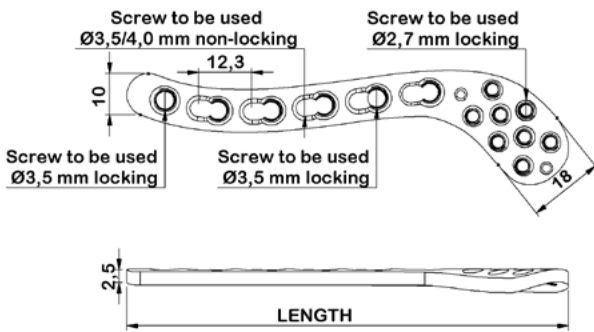

Intended use : Temporary fixation of fractures, malunions, nonunions, osteotomies and pseudoarthroses of the clavicle, for the treatment of acromioclavicular dislocations, particularly for patients with osteopenic bone.

3,5 mm Clavicle Reconstruction Locking Compression Plate



SS	TI	HOLES	SIDE	LENGTH (mm)
A1531806	A1530806	6	Left	94,3
A1531807	A1530807	7	Left	107,8
A1531813	A1530813	8	Left	121
A1531809	A1530809	9	Left	133
A1531906	A1530906	6	Right	94,3
A1531907	A1530907	7	Right	107,8
A1531913	A1530913	8	Right	121
A1531910	A1530910	9	Right	133

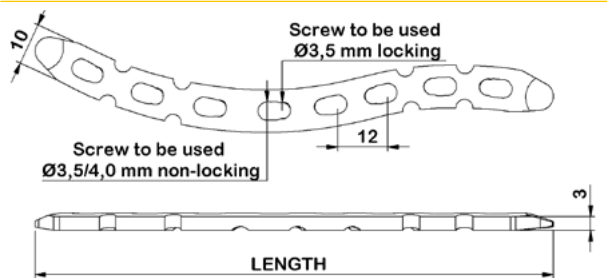

Intended use : Temporary fixation of fractures, malunions, nonunions, osteotomies and pseudoarthroses of the clavicle, particularly for patients with osteopenic bone.

Small Fragment Locking Plates

3,5 mm Proximal Humerus Locking Compression Plate 1



SS	TI	HOLES	LENGTH (mm)
A1620903	A1620803	3	61,1
A1620904	A1620804	4	73,1
A1620905	A1620805	5	85,1
A1620906	A1620806	6	97,1
A1620907	A1620807	7	109,1
A1620908	A1620808	8	121,1

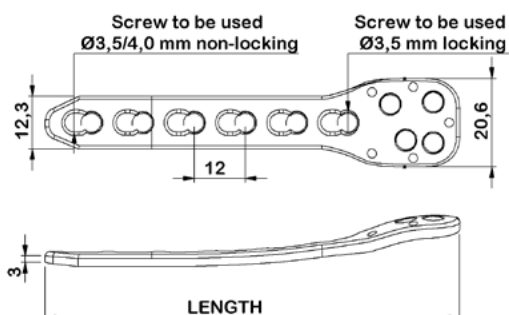

Intended use : Temporary fixation of fractures and fracture dislocations, malunions, nonunions, osteotomies and pseudoarthroses of the proximal humerus, particularly for adult patients with osteopenic bone.

3,5 mm Proximal Humerus Locking Compression Plate 2

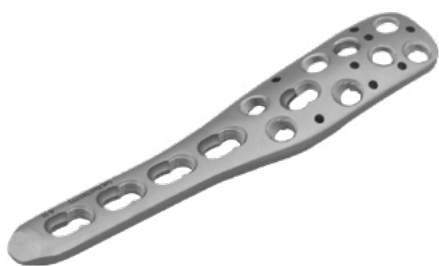

SS	TI	HOLES	LENGTH (mm)
A1630903	A1630803	3	87
A1630904	A1630804	4	99
A1630905	A1630805	5	111
A1630906	A1630806	6	123
A1630907	A1630807	7	135
A1630908	A1630808	8	147
A1630909	A1630809	9	159

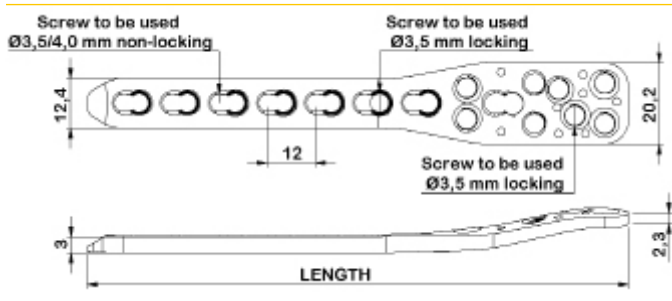

Intended use : Temporary fixation of fractures and fracture dislocations, malunions, nonunions, osteotomies and pseudoarthroses of the proximal humerus, particularly for adult patients with osteopenic bone.

Small Fragment Locking Plates

3,5 mm Proximal Humerus Locking Compression Plate 3

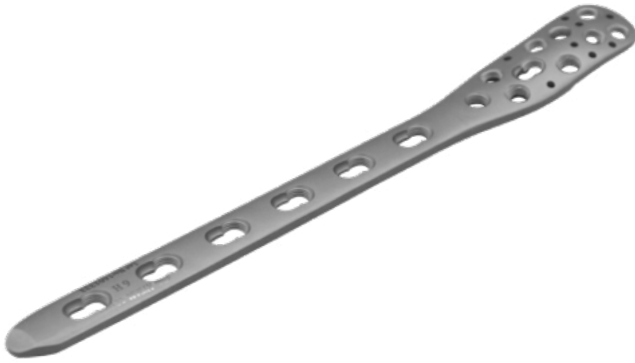

SS	TI	HOLES	LENGTH (mm)
A1640903	A1640803	3	122
A1640904	A1640804	4	140
A1640905	A1640805	5	158
A1640906	A1640806	6	176
A1640907	A1640807	7	194

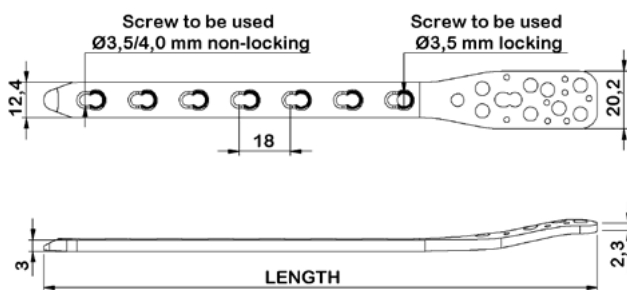

Intended use : Temporary fixation of fractures and fracture dislocations, malunions, nonunions, osteotomies and pseudoarthroses of the proximal humerus, particularly for adult patients with osteopenic bone.

3,5 mm Cloverleaf Locking Plate



SS	TI	HOLES	LENGTH (mm)
A101 02 270 0003	A111 02 270 0003	3	88,1
A101 02 270 0004	A111 02 270 0004	4	104,1
A101 02 270 0005	A111 02 270 0005	5	120,1
A101 02 270 0006	A111 02 270 0006	6	136,1
A101 02 270 0007	A111 02 270 0007	7	152,1
A101 02 270 0008	A111 02 270 0008	8	168,1

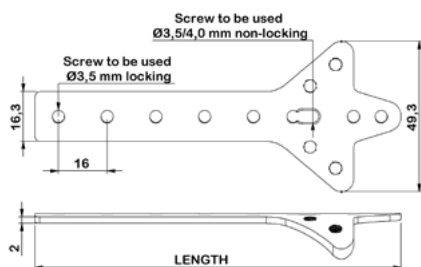

Intended use : Temporary fixation of intra-articular fractures of the distal tibia and proximal humerus fractures in adult patients.

Small Fragment Locking Plates

3,5 mm Distal Lateral Humerus Locking Plate



SS	TI	HOLES	SIDE	LENGTH (mm)
A5248105	A5238105	5	Left	56,5
A5248107	A5238107	7	Left	83,5
A5248109	A5238109	9	Left	108,5
A5248111	A5238111	11	Left	133,5
A5248113	A5238113	13	Left	158,5
A5248115	A5238115	15	Left	183,5
A5248205	A5238205	5	Right	56,5
A5248207	A5238207	7	Right	83,5
A5248209	A5238209	9	Right	108,5
A5248211	A5238211	11	Right	133,5
A5248213	A5238213	13	Right	158,5
A5248215	A5238215	15	Right	183,5

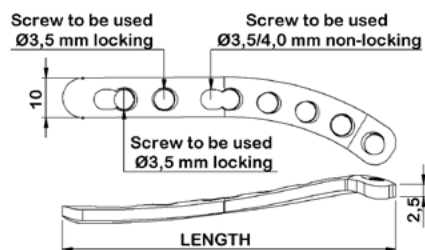

Intended use : Temporary fixation of fractures, malunions, nonunions, osteotomies and pseudoarthroses of the distal humerus (lateral approach), particularly for adult patients with osteopenic bone.

2,7/3,5 mm Distal Humerus Dorsolateral Locking Plate

with lateral support

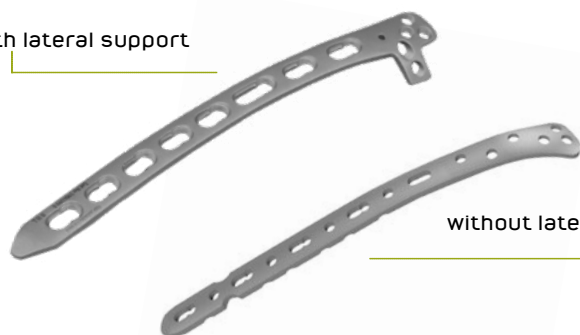

SS	TI	HOLES	SIDE	LENGTH (mm)
A9248105	A9238105	5	Left	103,9
A9248107	A9238107	7	Left	126,9
A9248109	A9238109	9	Left	152,9
A9248111	A9238111	11	Left	178,9
A9248113	A9238113	13	Left	204,9
A9248205	A9238205	5	Right	103,9
A9248207	A9238207	7	Right	126,9
A9248209	A9238209	9	Right	152,9
A9248211	A9238211	11	Right	178,9
A9248213	A9238213	13	Right	204,9

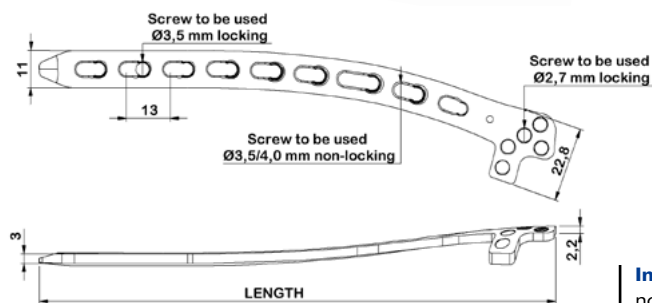

Intended use : Temporary fixation of fractures, malunions, nonunions, osteotomies and pseudoarthroses of the distal humerus (dorsolateral approach), particularly for adult patients with osteopenic bone.

Small Fragment Locking Plates

3,5 mm Distal Medial Humerus Locking Plate 1



SS	TI	HOLES	LENGTH (mm)
A5249206	A5249106	6	69,5
A5249208	A5249108	8	94
A5249210	A5249110	10	114
A5249212	A5249112	12	138,5
A5249214	A5249114	14	163
A5249216	A5249116	16	184

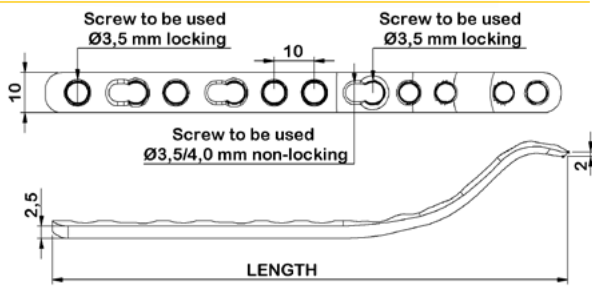

Intended use : Temporary fixation of fractures, malunions, nonunions, osteotomies and pseudoarthroses of the distal humerus (medial approach), particularly for adult patients with osteopenic bone.

2,7/3,5 mm Distal Medial Humerus Locking Plate 2



SS	TI	HOLES	SIDE	LENGTH (mm)
A1015279106	A1115278106	6	Left	84,8
A1015279108	A1115278108	8	Left	109,3
A1015279110	A1115278110	10	Left	133,8
A1015279112	A1115278112	12	Left	158,3
A1015279114	A1115278114	14	Left	182,8
A1015279116	A1115278116	16	Left	207,3
A1015279206	A1115278206	6	Right	84,8
A1015279208	A1115278208	8	Right	109,3
A1015279210	A1115278210	10	Right	133,8
A1015279212	A1115278212	12	Right	158,3
A1015279214	A1115278214	14	Right	182,8
A1015279216	A1115278216	16	Right	207,3

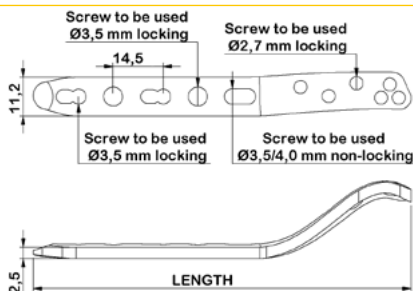

Intended use : Temporary fixation of fractures, malunions, nonunions, osteotomies and pseudoarthroses of the distal humerus (medial approach), particularly for adult patients with osteopenic bone.

Small Fragment Locking Plates

3,5 mm Y-Distal Humerus Locking Plate 1



SS	TI	HOLES	SIDE	LENGTH (mm)
A5319103	A5318103	3	Left	91,4
A5319104	A5318104	4	Left	106,4
A5319105	A5318105	5	Left	121,4
A5319106	A5318106	6	Left	136,4
A5319107	A5318107	7	Left	151,4
A5319108	A5318108	8	Left	166,4
A5319203	A5318203	3	Right	91,4
A5319204	A5318204	4	Right	106,4
A5319205	A5318205	5	Right	121,4
A5319206	A5318206	6	Right	136,4
A5319207	A5318207	7	Right	151,4
A5319208	A5318208	8	Right	166,4

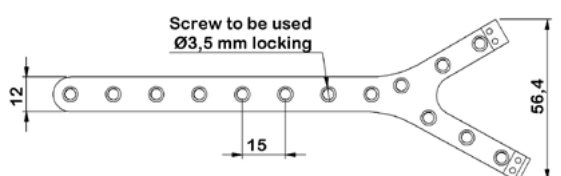

Intended use : Temporary fixation of fractures, malunions, nonunions, osteotomies and pseudoarthroses of the distal humerus, particularly for adult patients with osteopenic bone.

3,5 mm Olecranon Locking Compression Plate 1



SS	TI	HOLES	SIDE	LENGTH (mm)
A1651904	A1651804	4	Left	128,8
A1651906	A1651806	6	Left	153,7
A1651908	A1651808	8	Left	179,8
A1662904	A1662804	4	Right	128,8
A1662906	A1662806	6	Right	153,7
A1662908	A1662808	8	Right	179,8

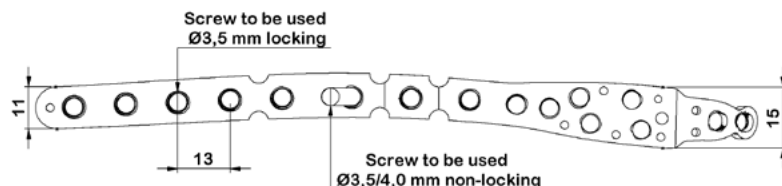

Intended use : Temporary fixation of fractures, malunions, nonunions, osteotomies and pseudoarthroses of the proximal ulna, particularly for adult patients with osteopenic bone.

Small Fragment Locking Plates

3,5 mm Olecranon Locking Compression Plate 2



SS	TI	HOLES	SIDE	LENGTH (mm)
A22024130	A22014130	3	Left	67,2
A22024140	A22014140	4	Left	79,6
A22024150	A22014150	5	Left	92,1
A22024160	A22014160	6	Left	104,6
A22024170	A22014170	7	Left	117
A22024180	A22014180	8	Left	129,4
A22024230	A22014230	3	Right	67,2
A22024240	A22014240	4	Right	79,6
A22024250	A22014250	5	Right	92,1
A22024260	A22014260	6	Right	104,6
A22024270	A22014270	7	Right	117
A22024280	A22014280	8	Right	129,4

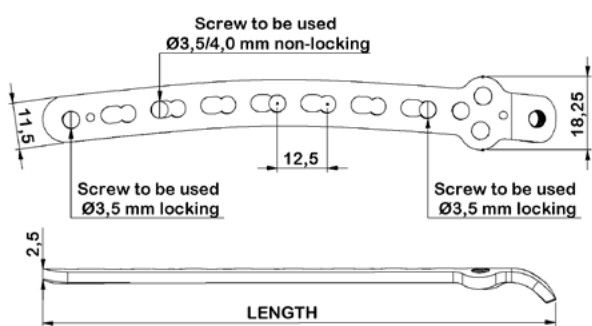

Intended use : Temporary fixation of fractures, malunions, nonunions, osteotomies and pseudoarthroses of the proximal ulna, particularly for adult patients with osteopenic bone.

3,5 mm Metaphysis Locking Compression Plate



SS	TI	HOLES	LENGTH (mm)
A1060906	A1060806	6	86
A1060907	A1060807	7	99
A1060908	A1060808	8	112
A1060909	A1060809	9	125
A1060911	A1060811	11	151
A1060913	A1060813	13	177

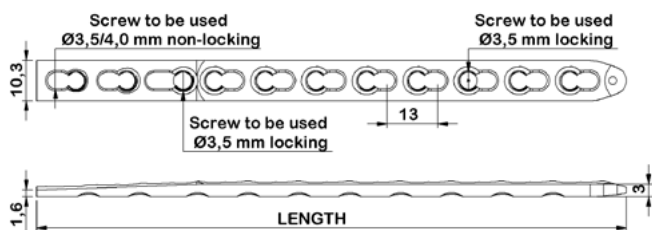

Intended use : Temporary fixation of fractures, malunions, nonunions, osteotomies and pseudoarthroses of the various long bones, excluding the femur in adult patients, particularly for patients with osteopenic bone.

Small Fragment Locking Plates

3,5 mm Locking Compression Hook Plate



SS	TI	HOLES	LENGTH (mm)
A1610905	A1610805	5	64,4
A1610906	A1610806	6	72,9
A1610907	A1610807	7	81,4
A1610908	A1610808	8	89,9
A1610909	A1610809	9	98,4
A1610910	A1610810	10	106,9
A1610911	A1610811	11	115,4
A1610912	A1610812	12	123,9
A1610913	A1610813	13	132,4

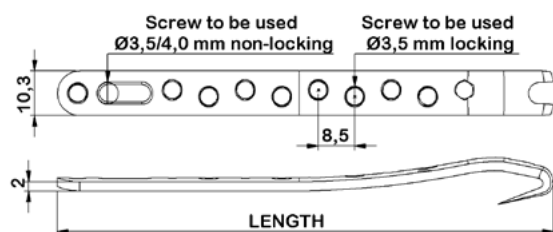

Intended use : Temporary fixation of fractures, malunions, nonunions, osteotomies and pseudoarthroses of the ulna, radius and fibula, particularly for adult patients with osteopenic bone.

3,5 mm Locking Compression Plate



SS	TI	HOLES	LENGTH (mm)
A1840904	A1820804	4	58
A1840905	A1820805	5	72
A1840906	A1820806	6	86
A1840907	A1820807	7	100
A1840908	A1820808	8	114
A1840909	A1820809	9	128
A1840910	A1820810	10	142
A1840911	A1820811	11	156
A1840912	A1820812	12	170

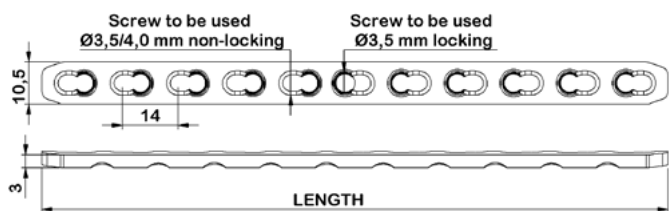

Intended use : Temporary fixation of fractures, malunions, nonunions, osteotomies and pseudoarthroses of the clavicle, scapula, olecranon, humerus, radius, ulna, pelvis, distal tibia, fibula, particularly in osteopenic bone for adult patients. These plates are also indicated for fracture fixation of diaphyseal and metaphyseal areas of long bones in pediatric patients.

Small Fragment Locking Plates

1/3 Tubular Locking Plate



SS	TI	HOLES	LENGTH (mm)
A5051004	A5050004	4	54
A5051005	A5050005	5	66
A5051006	A5050006	6	78
A5051007	A5050007	7	90
A5051008	A5050008	8	102
A5051009	A5050009	9	114
A5051010	A5050010	10	126
A5051011	A5050011	11	138
A5051012	A5050012	12	150
A5051013	A5050013	13	162

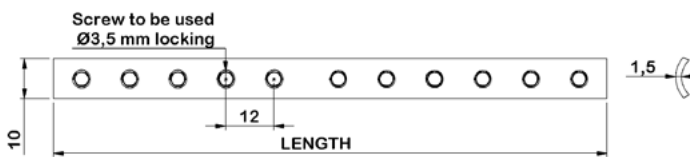

Intended use : Temporary fixation of fractures, malunions, nonunions, osteotomies and pseudoarthroses of small bones, including the ulna, radius and fibula, particularly for patients with osteopenic bone.

3,5 mm Reconstruction Locking Plate



SS	TI	HOLES	LENGTH (mm)
A1050904	A1050804	4	48
A1050905	A1050805	5	60
A1050906	A1050806	6	72
A1050907	A1050807	7	84
A1050908	A1050808	8	96
A1050909	A1050809	9	108
A1050910	A1050810	10	120
A1050911	A1050811	11	132
A1050912	A1050812	12	144

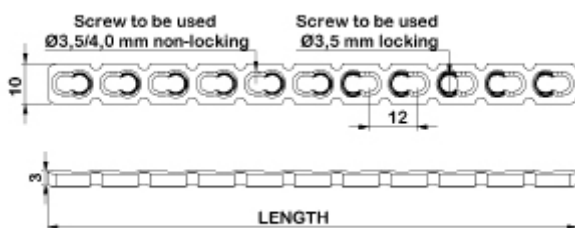

Intended use : Temporary fixation of fractures, malunions, nonunions, osteotomies and pseudoarthroses of the clavicle, scapula, olecranon, humerus, radius, ulna, pelvis, distal tibia, fibula for adult patients. These plates are also indicated for fracture fixation of diaphyseal and metaphyseal areas of long bones in pediatric patients.

Small Fragment Locking Plates

3,5 mm Ulna/Radius Anatomic Locking Plate



SS	TI	HOLES	LENGTH (mm)
A1822005	A1821005	5	69
A1822006	A1821006	6	82
A1822007	A1821007	7	95,4
A1822008	A1821008	8	108,8
A1822009	A1821009	9	121,2

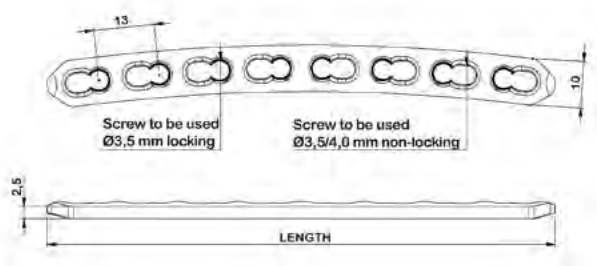

Intended use : Temporary fixation of fractures, malunions, nonunions, osteotomies and pseudoarthroses of the midshaft ulna and radius, particularly for patients with osteopenic bone.

3,5 mm Curved Reconstruction Locking Plate



SS	TI	HOLES	LENGTH (mm)
A101 02 221 0004	A111 02 221 0004	4	61,4
A101 02 221 0005	A111 02 221 0005	5	77,8
A101 02 221 0006	A111 02 221 0006	6	93,7
A101 02 221 0007	A111 02 221 0007	7	109,4
A101 02 221 0008	A111 02 221 0008	8	125,0
A101 02 221 0009	A111 02 221 0009	9	140,2
A101 02 221 0010	A111 02 221 0010	10	155,0
A101 02 221 0011	A111 02 221 0011	11	169,9
A101 02 221 0012	A111 02 221 0012	12	184,7
A101 02 221 0013	A111 02 221 0013	13	198,0
A101 02 221 0014	A111 02 221 0014	14	212,0

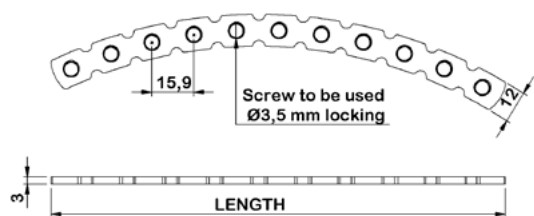

Intended use : Temporary fixation of fractures, malunions, nonunions, osteotomies and pseudoarthroses of the pelvis, particularly for patients with osteopenic bone.

Small Fragment Locking Plates

2,7/3,5 mm Distal Radius Locking Plate 1



SS	TI	HOLES	SIDE	LENGTH (mm)
A5159303	A5159103	3	Left	54
A5159304	A5159104	4	Left	62
A5159305	A5159105	5	Left	70
A5159306	A5159106	6	Left	78
A5159307	A5159107	7	Left	86
A5159403	A5159203	3	Right	54
A5159404	A5159204	4	Right	62
A5159405	A5159205	5	Right	70
A5159406	A5159206	6	Right	78
A5159407	A5159207	7	Right	86

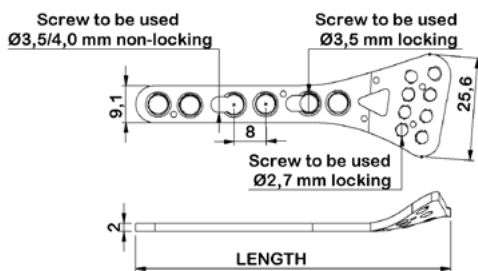

Intended use : Temporary fixation of complex intra-articular and extra-articular fractures and osteotomies of the distal radius in adults, skeletally mature adolescents.

2,7/3,5 mm Distal Radius Locking Plate 2



SS	TI	HOLES	SIDE	LENGTH (mm)
A5169303	A5169103	3	Left	63,2
A5169304	A5169104	4	Left	71,2
A5169305	A5169105	5	Left	79,2
A5169306	A5169106	6	Left	87,2
A5169307	A5169107	7	Left	95,2
A5169403	A5169203	3	Right	63,2
A5169404	A5169204	4	Right	71,2
A5169405	A5169205	5	Right	79,2
A5169406	A5169206	6	Right	87,2
A5169407	A5169207	7	Right	95,2

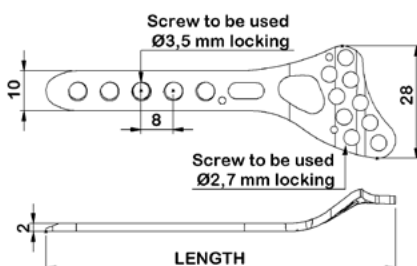

Intended use : Temporary fixation of complex intra-articular and extra-articular fractures and osteotomies of the distal radius in adults, skeletally mature adolescents.

Small Fragment Locking Plates

3,5 mm Locking Compression T-Plate, Right-Angled (3 Holes on Head)



SS	TI	HOLES	LENGTH (mm)
A1480903	A1480803	3	49
A1480904	A1480804	4	61
A1480905	A1480805	5	73
A1480906	A1480806	6	85

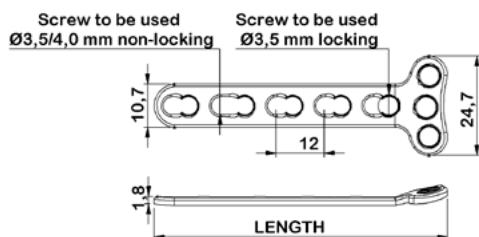

Intended use : Temporary fixation of complex intra-articular and extra-articular fractures and osteotomies of the distal radius in adults, skeletally mature adolescents.

3,5 mm Locking Compression T-Plate Oblique-Angled



SS	TI	HOLES	SIDE	LENGTH (mm)
A1511903	A1511803	3	Left	53
A1511904	A1511804	4	Left	66,5
A1511905	A1511805	5	Left	80
A1511906	A1511806	6	Left	93,5
A1522903	A1522803	3	Right	53
A1522904	A1522804	4	Right	66,5
A1522905	A1522805	5	Right	80
A1522906	A1522806	6	Right	93,5

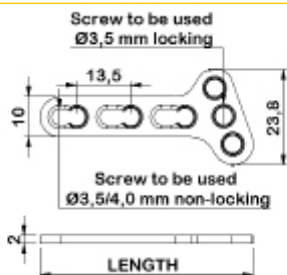

Intended use : Temporary fixation of complex intra-articular and extra-articular fractures and osteotomies of the distal radius in adults, skeletally mature adolescents.

Small Fragment Locking Plates

3,5 mm Locking Compression T-Plate, Right-Angled (4 Holes on Head)



SS	TI	HOLES	LENGTH (mm)
A1480930	A1480830	3	46
A1480940	A1480840	4	57
A1480950	A1480850	5	68
A1480960	A1480860	6	80

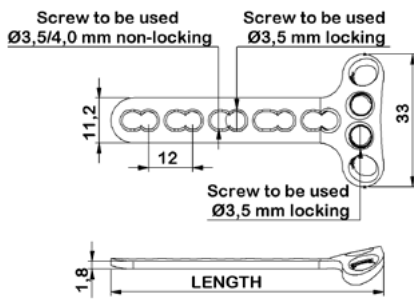

Intended use : Temporary fixation of complex intra-articular and extra-articular fractures and osteotomies of the distal radius in adults, skeletally mature adolescents.

2,7 mm Radius Head Locking Plate



SS	TI	HOLES	LENGTH (mm)
A5159603	A5159503	3	33
A5159605	A5159505	5	47

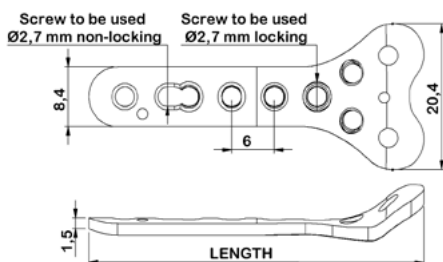

Intended use : Temporary fixation of extra-articular and intra-articular fractures of the proximal radius and multifragmented radial neck fractures in adults, skeletally mature adolescents.

Small Fragment Locking Plates

2,7 mm Hallux-Valgus Locking Plate



TI	HOLES	SIDE	LENGTH (mm)
A312 02 062 0402	2	90° Left	33
A312 02 062 0403	3	90° Left	35
A312 02 062 0404	4	90° Left	37
A312 02 062 0202	2	110° Left	33
A312 02 062 0203	3	110° Left	35
A312 02 062 0204	4	110° Left	37
A312 02 061 0302	2	90° Right	33
A312 02 061 0303	3	90° Right	35
A312 02 061 0304	4	90° Right	37
A312 02 061 0102	2	110° Right	33
A312 02 061 0103	3	110° Right	35
A312 02 061 0104	4	110° Right	37

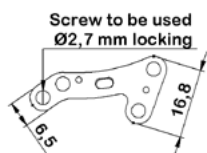

Intended use : Temporary fixation of hallux valgus osteotomies of adult patients.

Attachment Locking Plate Small



TI	TYPE
A110 02 190 0006	Small

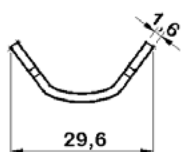

Intended use : For augmented temporary fixation of fractures, used as an attachment of 3.5 mm locking compression plates.



Small Fragment Non-Locking Plates

3,5 mm Clavicle Plate



SS	TI	HOLES	SIDE	LENGTH (mm)
A5089106	A5088106	6	Left	70
A5089107	A5088107	7	Left	84
A5089108	A5088108	8	Left	98
A5089109	A5088109	9	Left	112
A5089206	A5088206	6	Right	70
A5089207	A5088207	7	Right	84
A5089208	A5088208	8	Right	98
A5089209	A5088209	9	Right	112

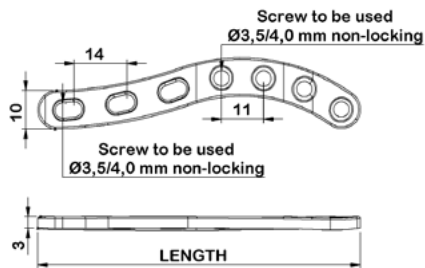

Intended use : Temporary fixation of fractures, malunions, nonunions, osteotomies and pseudoarthroses of the clavicle.

3,5 mm Clavicle Hook Plate



SS	TI	HOLES	SIDE	LENGTH (mm)
A5269104	A5268104	4	Left	63
A5269105	A5268105	5	Left	75
A5269106	A5268106	6	Left	86
A5269107	A5268107	7	Left	97
A5269204	A5268204	4	Right	63
A5269205	A5268205	5	Right	75
A5269206	A5268206	6	Right	86
A5269207	A5268207	7	Right	97

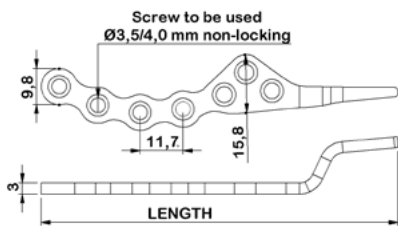

Intended use : Temporary fixation of fractures, malunions, nonunions, osteotomies and pseudoarthroses of the clavicle, for the treatment of acromioclavicular dislocations

Small Fragment Non-Locking Plates

3,5 mm Cloverleaf Plate



SS	TI	HOLES	LENGTH (mm)
A100 02 270 0003	A110 02 270 0003	3	88,1
A100 02 270 0004	A110 02 270 0004	4	104,1
A100 02 270 0005	A110 02 270 0005	5	120,1
A100 02 270 0006	A110 02 270 0006	6	136,1
A100 02 270 0007	A110 02 270 0007	7	152,1
A100 02 270 0008	A110 02 270 0008	8	168,1

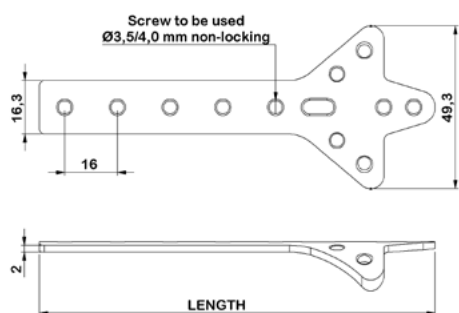

Intended use : Temporary fixation of intra-articular fractures of the distal tibia and proximal humerus fractures in adult patients.

3,5 mm Y-Distal Humerus Plate 1

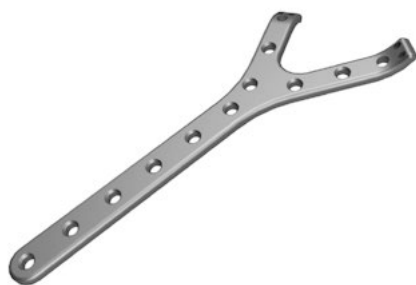

SS	TI	HOLES	SIDE	LENGTH (mm)
A5219103	A5218103	3	Left	91,4
A5219104	A5218104	4	Left	106,4
A5219105	A5218105	5	Left	121,4
A5219106	A5218106	6	Left	136,4
A5219107	A5218107	7	Left	151,4
A5219108	A5218108	8	Left	166,4
A5219203	A5218203	3	Right	91,4
A5219204	A5218204	4	Right	106,4
A5219205	A5218205	5	Right	121,4
A5219206	A5218206	6	Right	136,4
A5219207	A5218207	7	Right	151,4
A5219208	A5218208	8	Right	166,4

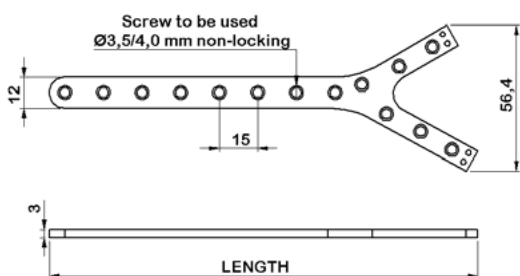

Intended use : Temporary fixation of fractures, malunions, nonunions, osteotomies and pseudoarthroses of the distal humerus in adult patients.

Small Fragment Non-Locking Plates

3,5 mm Y-Distal Humerus Plate 2



SS	TI	HOLES	LENGTH (mm)
A100 02 224 1205	A110 02 224 1205	5	137
A100 02 224 1206	A110 02 224 1206	6	153
A100 02 224 1207	A110 02 224 1207	7	169
A100 02 224 1209	A110 02 224 1209	9	201

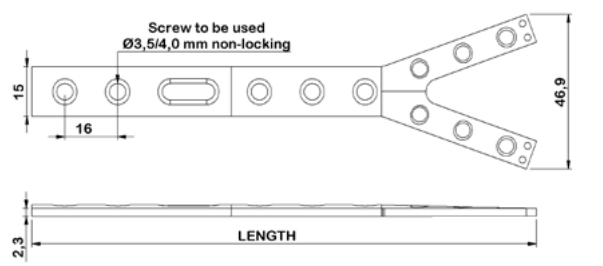

Intended use : Temporary fixation of fractures, malunions, nonunions, osteotomies and pseudoarthroses of the distal humerus in adult patients.

3,5 mm Ulnar Olecranon Plate



SS	TI	HOLES	SIDE	LENGTH (mm)
A100 02 224 1104	A22014040	4	Left	79,6
A100 02 224 1105	A22014050	5	Left	92,1
A100 02 224 1103	A22014060	6	Left	104,6
A100 02 224 1004	A22014030	4	Right	79,6
A100 02 224 1005	A22014070	5	Right	92,1
A100 02 224 1003	A22014080	6	Right	104,6

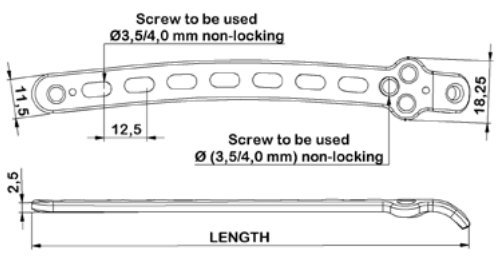

Intended use : Temporary fixation of fractures, malunions, nonunions, osteotomies and pseudoarthroses of the proximal ulna in adult patients.

Small Fragment Non-Locking Plates

3,5 mm Distal Medial Humerus Reconstruction Plate



TI	HOLES	LENGTH (mm)
A5249010	10	69,6
A5249012	12	85
A5249014	14	100,4

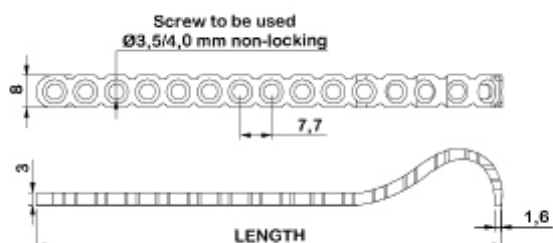

Intended use : Temporary fixation of fractures, malunions, nonunions, osteotomies and pseudoarthroses of the distal humerus (medial approach) in adults.

3,5 mm Y-Distal Humerus Reconstruction Plate

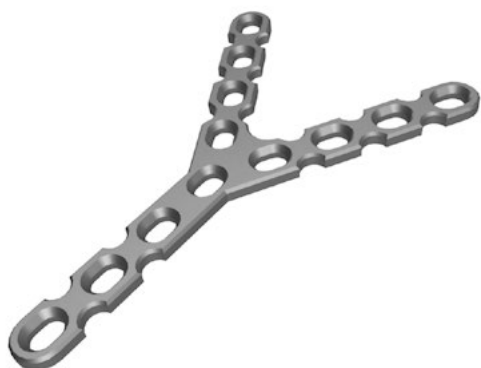

SS	TI	LENGTH (mm)
A100 02 224 0000	A110 02 224 0000	88,6

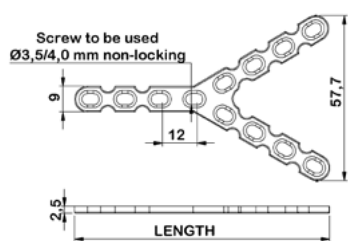

Intended use : Temporary fixation of fractures, malunions, nonunions, osteotomies and pseudoarthroses of the distal humerus in adults.

Small Fragment Non-Locking Plates

1/3 Tubular Plate

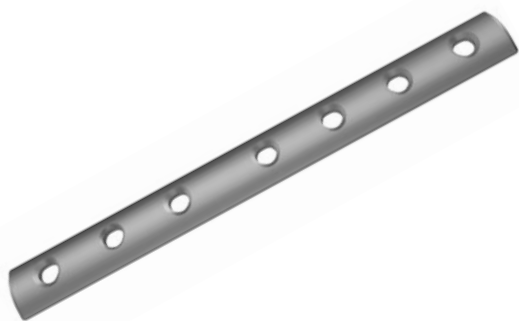

SS	TI	HOLES	LENGTH (mm)
A100 02 181 0004	A110 02 181 0004	4	54
A100 02 181 0005	A110 02 181 0005	5	66
A100 02 181 0006	A110 02 181 0006	6	78
A100 02 181 0007	A110 02 181 0007	7	90
A100 02 181 0008	A110 02 181 0008	8	102
A100 02 181 0009	A110 02 181 0009	9	114
A100 02 181 0010	A110 02 181 0010	10	126
A100 02 181 0011	A110 02 181 0011	11	138
A100 02 181 0012	A110 02 181 0012	12	150

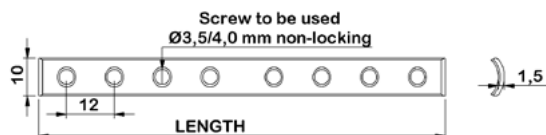

Intended use : Fractures, osteotomies, nonunions and malunions of small bones, including the ulna, radius and fibula.

Quarter 1/4 Tubular Plate



SS	TI	HOLES	LENGTH (mm)
A100 02 182 0003	A110 02 170 0003	3	23
A100 02 182 0004	A110 02 170 0004	4	31
A100 02 182 0005	A110 02 170 0005	5	39
A100 02 182 0006	A110 02 170 0006	6	47
A100 02 182 0007	A110 02 170 0007	7	55
A100 02 182 0008	A110 02 170 0008	8	63
A100 02 182 0009	A110 02 170 0009	9	71
A100 02 182 0010	A110 02 170 0010	10	79

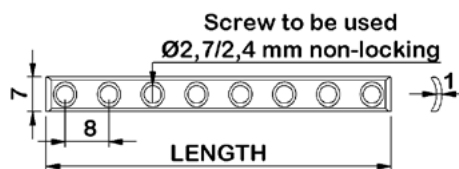

Intended use : Temporary fixation of fractures, malunions, nonunions, osteotomies and pseudoarthroses of small bones, including the ulna, radius and fibula, metacarpal and metatarsal bones.

Small Fragment Non-Locking Plates

3,5 mm Thin Narrow Plate DCP



SS	TI	HOLES	LENGTH (mm)
A100 02 171 0004	A110 02 171 0004	4	54
A100 02 171 0005	A110 02 171 0005	5	66
A100 02 171 0006	A110 02 171 0006	6	78
A100 02 171 0007	A110 02 171 0007	7	90
A100 02 171 0008	A110 02 171 0008	8	102
A100 02 171 0009	A110 02 171 0009	9	114
A100 02 171 0010	A110 02 171 0010	10	126
A100 02 171 0012	A110 02 171 0012	12	150

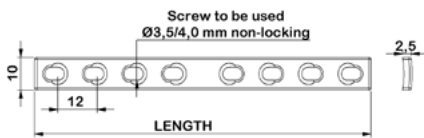

Intended use : Temporary fixation of fractures, malunions, nonunions, osteotomies and pseudoarthroses of the clavicle, scapula, olecranon, humerus, radius, ulna, pelvis, distal tibia, fibula. These plates are also indicated for fracture fixation of diaphyseal and metaphyseal areas of long bones in pediatric patients.

3,5 mm Straight Reconstruction Plate



SS	TI	HOLES	LENGTH (mm)
A100 02 220 0004	A110 02 220 0004	4	48
A100 02 220 0005	A110 02 220 0005	5	60
A100 02 220 0006	A110 02 220 0006	6	72
A100 02 220 0007	A110 02 220 0007	7	84
A100 02 220 0008	A110 02 220 0008	8	96
A100 02 220 0009	A110 02 220 0009	9	108
A100 02 220 0010	A110 02 220 0010	10	120
A100 02 220 0011	A110 02 220 0011	11	132
A100 02 220 0012	A110 02 220 0012	12	144

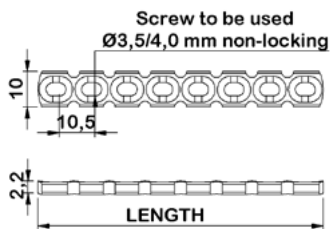

Intended use : Temporary fixation of fractures, malunions, nonunions, osteotomies and pseudoarthroses of the clavicle, scapula, olecranon, humerus, radius, ulna, pelvis, distal tibia, fibula for adult patients. These plates are also indicated for fracture fixation of diaphyseal and metaphyseal areas of long bones in pediatric patients.

Small Fragment Non-Locking Plates

3,5 mm Curved Reconstruction Plate



SS	TI	HOLES	LENGTH (mm)
A100 02 221 0002	A110 02 221 0002	2	29,1
A100 02 221 0003	A110 02 221 0003	3	45,1
A100 02 221 0004	A110 02 221 0004	4	60,8
A100 02 221 0005	A110 02 221 0005	5	76,9
A100 02 221 0006	A110 02 221 0006	6	92,7
A100 02 221 0007	A110 02 221 0007	7	108,2
A100 02 221 0008	A110 02 221 0008	8	123,6
A100 02 221 0009	A110 02 221 0009	9	138,7
A100 02 221 0010	A110 02 221 0010	10	153,9
A100 02 221 0011	A110 02 221 0011	11	168,4
A100 02 221 0012	A110 02 221 0012	12	183,2

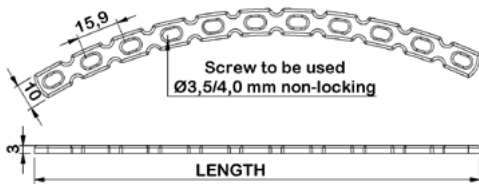

Intended use : Temporary fixation of fractures, malunions, nonunions, osteotomies and pseudoarthroses of the pelvis

3,5 mm T-Plate Right-Angled (3 Holes On Head)



SS	TI	HOLES	LENGTH (mm)
A300 02 079 003	A310 02 079 003	3	49
A300 02 079 004	A310 02 079 004	4	61
A300 02 079 005	A310 02 079 005	5	73
A300 02 079 006	A310 02 079 006	6	85

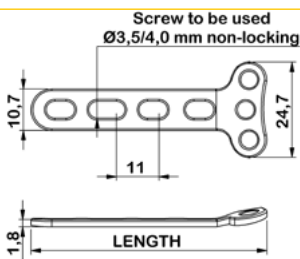

Intended use : Temporary fixation of complex intra-articular and extra-articular fractures and osteotomies of the distal radius in adults, skeletally mature adolescents.

Small Fragment Non-Locking Plates

3,5 mm T-Plate Right-Angled (4 Holes On Head)



SS	TI	HOLES	LENGTH (mm)
A300 02 080 0003	A310 02 080 0003	3	46
A300 02 080 0004	A310 02 080 0004	4	57
A300 02 080 0005	A310 02 080 0005	5	68
A300 02 080 0006	A310 02 080 0006	6	79

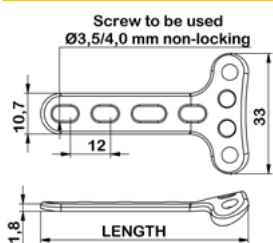

Intended use : Temporary fixation of complex intra-articular and extra-articular fractures and osteotomies of the distal radius in adults, skeletally mature adolescents.

3,5 mm Compression T-Plate Oblique-Angled



SS	TI	HOLES	SIDE	LENGTH (mm)
A300 02 090 0003	A310 02 090 0003	3	Left	52,5
A300 02 090 0004	A310 02 090 0004	4	Left	66
A300 02 090 0005	A310 02 090 0005	5	Left	79,5
A300 02 090 0006	A310 02 090 0006	6	Left	93
A300 02 091 0003	A310 02 091 0003	3	Right	52,5
A300 02 091 0004	A310 02 091 0004	4	Right	66
A300 02 091 0005	A310 02 091 0005	5	Right	79,5
A300 02 091 0006	A310 02 091 0006	6	Right	93

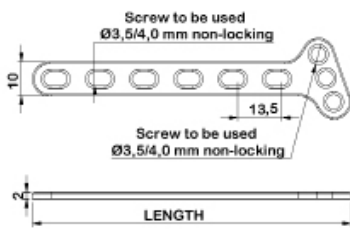

Intended use : Temporary fixation of complex intra-articular and extra-articular fractures and osteotomies of the distal radius in adults, skeletally mature adolescents.

"We supply WORLD's
Orthopedic & Trauma
Implants..."

Small Fragment Screws

Locking/Non-Locking



Small Fragment Locking Screws

3,5 mm Self-Tapping Locking Screw



SS	TI	DIA. x LENGTH (mm)	SS	TI	DIA. x LENGTH (mm)
A1993510	A1983510	3,5X10	A1993530	A1983530	3,5X30
A1993512	A1983512	3,5X12	A1993532	A1983532	3,5X32
A1993514	A1983514	3,5X14	A1993534	A1983534	3,5X34
A1993516	A1983516	3,5X16	A1993536	A1983536	3,5X36
A1993518	A1983518	3,5X18	A1993538	A1983538	3,5X38
A1993520	A1983520	3,5X20	A1993540	A1983540	3,5X40
A1993522	A1983522	3,5X22	A1993542	A1983542	3,5X42
A1993524	A1983524	3,5X24	A1993544	A1983544	3,5X44
A1993526	A1983526	3,5X26	A1993546	A1983546	3,5X46
A1993528	A1983528	3,5X28	A1993548	A1983548	3,5X48
			A1993550	A1983550	3,5X50
			A1993555	A1983555	3,5X55
			A1993560	A1983560	3,5X60

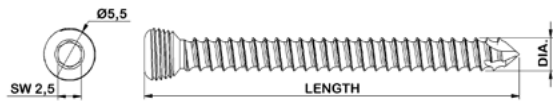

3,5 mm Low-Profile Locking Screw



TI	DIA. x LENGTH (mm)	TI	DIA. x LENGTH (mm)
A1973510	3,5X10	A1973520	3,5X20
A1973512	3,5X12	A1973522	3,5X22
A1973514	3,5X14	A1973524	3,5X24
A1973516	3,5X16	A1973526	3,5X26
A1973518	3,5X18	A1973528	3,5X28

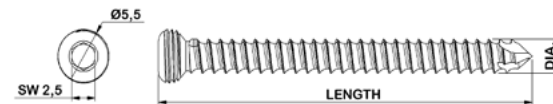

3,5 mm Locking Cancellous Screw Full Threaded



SS	TI	DIA. x LENGTH (mm)	SS	TI	DIA. x LENGTH (mm)
A33803510	A33703510	3,5X10	A33803530	A33703530	3,5X30
A33803512	A33703512	3,5X12	A33803532	A33703532	3,5X32
A33803514	A33703514	3,5X14	A33803534	A33703534	3,5X34
A33803516	A33703516	3,5X16	A33803536	A33703536	3,5X36
A33803518	A33703518	3,5X18	A33803538	A33703538	3,5X38
A33803520	A33703520	3,5X20	A33803540	A33703540	3,5X40
A33803522	A33703522	3,5X22	A33803542	A33703542	3,5X42
A33803524	A33703524	3,5X24	A33803544	A33703544	3,5X44
A33803526	A33703526	3,5X26	A33803546	A33703546	3,5X46
A33803528	A33703528	3,5X28	A33803548	A33703548	3,5X48
			A33803550	A33703550	3,5X50
			A33803555	A33703555	3,5X55
			A33803560	A33703560	3,5X60

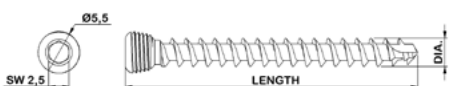

Small Fragment Locking Screws

3,5 mm Locking Cancellous Screw Partially Threaded



SS	TI	DIA. x LENGTH (mm)	SS	TI	DIA. x LENGTH (mm)
A33813520	A33713520	3,5X20	A33813538	A33713538	3,5X38
A33813522	A33713522	3,5X22	A33813540	A33713540	3,5X40
A33813524	A33713524	3,5X24	A33813542	A33713542	3,5X42
A33813526	A33713526	3,5X26	A33813544	A33713544	3,5X44
A33813528	A33713528	3,5X28	A33813546	A33713546	3,5X46
A33813530	A33713530	3,5X30	A33813548	A33713548	3,5X48
A33813532	A33713532	3,5X32	A33813550	A33713550	3,5X50
A33813534	A33713534	3,5X34	A33813555	A33713555	3,5X55
A33813536	A33713536	3,5X36	A33813560	A33713560	3,5X60

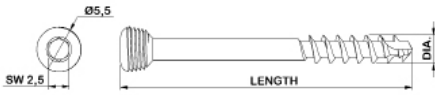

3,5 mm Cable Locking Screw

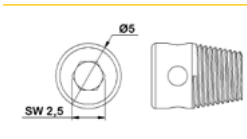

TI
A900 03 020 0005

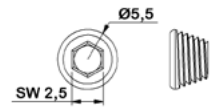

TI
A900 03 020 0009

2,4 mm Locking Screw (5,5 mm Head Diameter)



SS	TI	DIA. x LENGTH (mm)	SS	TI	DIA. x LENGTH (mm)
A1992306	A2065014	2,4X6	A1992324	A2065032	2,4X24
A1992308	A2065016	2,4X8	A1992326	A2065034	2,4X26
A1992310	A2065018	2,4X10	A1992328	A2065036	2,4X28
A1992312	A2065020	2,4X12	A1992330	A2065038	2,4X30
A1992314	A2065022	2,4X14	A1992332	A2065040	2,4X32
A1992316	A2065024	2,4X16	A1992334	A2065042	2,4X34
A1992318	A2065026	2,4X18	A1992336	A2065044	2,4X36
A1992320	A2065028	2,4X20	A1992338	A2065046	2,4X38
A1992322	A2065030	2,4X22	A1992340	A2065048	2,4X40

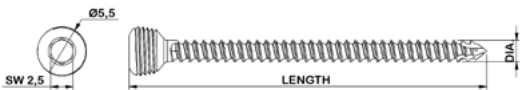

Small Fragment Locking Screws

2,7 mm Mini Locking Screw

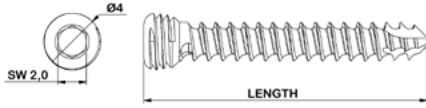

TI	DIA. x LENGTH (mm)	TI	DIA. x LENGTH (mm)
A1982710	2,7X10	A1982726	2,7X26
A1982712	2,7X12	A1982728	2,7X28
A1982714	2,7X14	A1982730	2,7X30
A1982716	2,7X16	A1982732	2,7X32
A1982718	2,7X18	A1982734	2,7X34
A1982720	2,7X20	A1982736	2,7X36
A1982722	2,7X22	A1982738	2,7X38
A1982724	2,7X24	A1982740	2,7X40

2,7 mm Mini Locking Screw (5,5 mm Head Diameter)

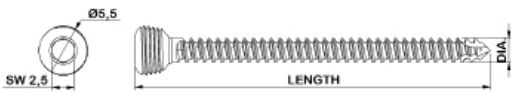

SS	TI	DIA. x LENGTH (mm)	SS	TI	DIA. x LENGTH (mm)
A1992706	A2065050	2,7X6	A1992720	A2065085	2,7X20
A1992708	A2065055	2,7X8	A1992722	A2065090	2,7X22
A1992710	A2065060	2,7X10	A1992724	A1992005	2,7X24
A1992712	A2065065	2,7X12	A1992726	A1992007	2,7X26
A1992714	A2065070	2,7X14	A1992728	A1992009	2,7X28
A1992716	A2065075	2,7X16	A1992730	A1992011	2,7X30
A1992718	A2065080	2,7X18	A1992732	A1992013	2,7X32
			A1992734	A1992015	2,7X34
			A1992736	A1992017	2,7X36
			A1992738	A1992019	2,7X38
			A1992740	A1992021	2,7X40

3,5 mm Self-Drilling Locking Screw

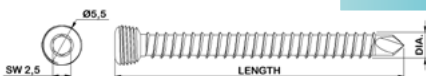

SS	TI	DIA. x LENGTH (mm)	SS	TI	DIA. x LENGTH (mm)
A2393510	A2383510	3,5X10	A2393530	A2383530	3,5X30
A2393512	A2383512	3,5X12	A2393532	A2383532	3,5X32
A2393514	A2383514	3,5X14	A2393534	A2383534	3,5X34
A2393516	A2383516	3,5X16	A2393536	A2383536	3,5X36
A2393518	A2383518	3,5X18	A2393538	A2383538	3,5X38
A2393520	A2383520	3,5X20	A2393540	A2383540	3,5X40
A2393522	A2383522	3,5X22	A2393542	A2383542	3,5X42
A2393524	A2383524	3,5X24	A2393544	A2383544	3,5X44
A2393526	A2383526	3,5X26	A2393546	A2383546	3,5X46
A2393528	A2383528	3,5X28	A2393548	A2383548	3,5X48
			A2393550	A2383550	3,5X50
			A2393555	A2383555	3,5X55
			A2393560	A2383560	3,5X60

Small Fragment Locking/Non-Locking Screws

3,5 mm Self-Tapping Locking Cannulated Screw



SS	TI	DIA. x LENGTH (mm)	SS	TI	DIA. x LENGTH (mm)
A1953510	A1963510	3,5X10	A1863532	A1963532	3,5X32
A1953512	A1963512	3,5X12	A1863534	A1963534	3,5X34
A1953514	A1963514	3,5X14	A1863536	A1963536	3,5X36
A1953516	A1963516	3,5X16	A1863538	A1963538	3,5X38
A1953518	A1963518	3,5X18	A1953540	A1963540	3,5X40
A1953520	A1963520	3,5X20	A1863518	A1963565	3,5X42
A1953522	A1963522	3,5X22	A1863520	A1963570	3,5X44
A1953524	A1963524	3,5X24	A1863522	A1963546	3,5X46
A1953526	A1963526	3,5X26	A1863524	A1963548	3,5X48
A1953528	A1963528	3,5X28	A1953550	A1963550	3,5X50
A1953530	A1963530	3,5X30	A1953555	A1963555	3,5X55
			A1953560	A1963560	3,5X60

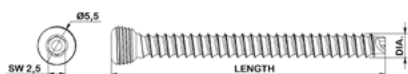

2,4 mm Mini Locking Screw



TI	DIA. x LENGTH (mm)	TI	DIA. x LENGTH (mm)
A110 03 213 0060	2,4X6	A100 03 216 0015	2,4X15
A100 03 216 0070	2,4X7	A110 03 213 0160	2,4X16
A110 03 213 0080	2,4X8	A110 03 213 0180	2,4X18
A100 03 216 0090	2,4X9	A110 03 213 0200	2,4X20
A110 03 213 0100	2,4X10	A110 03 213 0220	2,4X22
A100 03216 0011	2,4X11	A110 03 213 0240	2,4X24
A110 03 213 0120	2,4X12	A110 03 213 0260	2,4X26
A100 03 216 0013	2,4X13	A110 03 213 0280	2,4X28
A110 03 213 0140	2,4X14	A110 03 213 0300	2,4X30



2,4 mm Mini Screw



TI	DIA. x LENGTH (mm)	TI	DIA. x LENGTH (mm)
A1982306	2,4X6	A100 03216 0025	2,4X15
A100 03216 0017	2,4X7	A1982316	2,4X16
A1982308	2,4X8	A1982318	2,4X18
A100 03216 0019	2,4X9	A1982320	2,4X20
A1982310	2,4X10	A1982322	2,4X22
A100 03216 0021	2,4X11	A1982324	2,4X24
A1982312	2,4X12	A1982326	2,4X26
A100 03216 0023	2,4X13	A1982328	2,4X28
A1982314	2,4X14	A1982330	2,4X30



Small Fragment Non-Locking Screws

3,5 mm Cortical Screw (Pitch 1,25 mm)



SS	TI	DIA. x LENGTH (mm)
A100 03 218 0100	A110 03 218 0100	3,5X10
A100 03 218 0120	A110 03 218 0120	3,5X12
A100 03 218 0140	A110 03 218 0140	3,5X14
A100 03 218 0160	A110 03 218 0160	3,5X16
A100 03 218 0180	A110 03 218 0180	3,5X18
A100 03 218 0200	A110 03 218 0200	3,5X20
A100 03 218 0220	A110 03 218 0220	3,5X22
A100 03 218 0240	A110 03 218 0240	3,5X24
A100 03 218 0260	A110 03 218 0260	3,5X26
A100 03 218 0280	A110 03 218 0280	3,5X28

SS	TI	DIA. x LENGTH (mm)
A100 03 218 0300	A110 03 218 0300	3,5X30
A100 03 218 0320	A110 03 218 0320	3,5X32
A100 03 218 0340	A110 03 218 0340	3,5X34
A100 03 218 0360	A110 03 218 0360	3,5X36
A100 03 218 0380	A110 03 218 0380	3,5X38
A100 03 218 0400	A110 03 218 0400	3,5X40
A100 03 218 0420	A110 03 218 0420	3,5X42
A100 03 218 0440	A110 03 218 0440	3,5X44
A100 03 218 0460	A110 03 218 0460	3,5X46
A100 03 218 0480	A110 03 218 0480	3,5X48
A100 03 218 0500	A110 03 218 0500	3,5X50
A100 03 218 0520	A110 03 218 0520	3,5X52
A100 03 218 0540	A110 03 218 0540	3,5X54
A100 03 218 0560	A110 03 218 0560	3,5X56
A100 03 218 0580	A110 03 218 0580	3,5X58
A100 03 218 0600	A110 03 218 0600	3,5X60



3,5 mm Cancellous Bone Screw Full Threaded



SS	TI	DIA. x LENGTH (mm)
A100 03 219 0100	A110 03 219 0100	3,5X10
A100 03 219 0120	A110 03 219 0120	3,5X12
A100 03 219 0140	A110 03 219 0140	3,5X14
A100 03 219 0160	A110 03 219 0160	3,5X16
A100 03 219 0180	A110 03 219 0180	3,5X18
A100 03 219 0200	A110 03 219 0200	3,5X20
A100 03 219 0220	A110 03 219 0220	3,5X22
A100 03 219 0240	A110 03 219 0240	3,5X24
A100 03 219 0260	A110 03 219 0260	3,5X26
A100 03 219 0280	A110 03 219 0280	3,5X28
A100 03 219 0300	A110 03 219 0300	3,5X30

SS	TI	DIA. x LENGTH (mm)
A100 03 219 0320	A110 03 219 0320	3,5X32
A100 03 219 0340	A110 03 219 0340	3,5X34
A100 03 219 0360	A110 03 219 0360	3,5X36
A100 03 219 0380	A110 03 219 0380	3,5X38
A100 03 219 0400	A110 03 219 0400	3,5X40
A100 03 219 0420	A6183542	3,5X42
A100 03 219 0440	A110 03 219 0450	3,5X44
A100 03 219 0460	A6183546	3,5X46
A100 03 219 0480	A6183548	3,5X48
A100 03 219 0500	A110 03 219 0500	3,5X50
A100 03 219 0520	A6183552	3,5X52
A100 03 219 0540	A110 03 219 0540	3,5X54
A100 03 219 0560	A6183556	3,5X56
A100 03 219 0580	A110 03 219 0580	3,5X58
A100 03 219 0600	A6183560	3,5X60

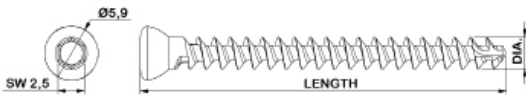

3,5 mm Cancellous Bone Screw Partially Threaded



SS	TI	DIA. x LENGTH (mm)
A6353520	A6153520	3,5X20
A6353522	A6153522	3,5X22
A6353524	A6153524	3,5X24
A6353526	A6153526	3,5X26
A6353528	A6153528	3,5X28
A6353530	A6153530	3,5X30
A6353532	A6153532	3,5X32

SS	TI	DIA. x LENGTH (mm)
A6353534	A6153534	3,5X34
A6353536	A6153536	3,5X36
A6353538	A6153538	3,5X38
A6353540	A6153540	3,5X40
A6353542	A6153542	3,5X42
A6353544	A6153544	3,5X44
A6353546	A6153546	3,5X46
A6353548	A6153548	3,5X48
A6353550	A6153550	3,5X50



Small Fragment Non-Locking Screws

4,0 mm Cancellous Bone Screw Full Threaded



SS	TI	DIA. x LENGTH (mm)	SS	TI	DIA. x LENGTH (mm)
A100 03 220 0100	A110 03 220 0100	4,0X10	A100 03 220 0200	A110 03 220 0200	4,0X20
A100 03 220 0120	A110 03 220 0120	4,0X12	A100 03 220 0220	A110 03 220 0220	4,0X22
A100 03 220 0140	A110 03 220 0140	4,0X14	A100 03 220 0240	A110 03 220 0240	4,0X24
A100 03 220 0160	A110 03 220 0160	4,0X16	A100 03 220 0260	A110 03 220 0260	4,0X26
A100 03 220 0180	A110 03 220 0180	4,0X18	A100 03 220 0280	A110 03 220 0280	4,0X28
			A100 03 220 0300	A110 03 220 0300	4,0X30
			A100 03 220 0350	A110 03 220 0350	4,0X35
			A100 03 220 0400	A110 03 220 0400	4,0X40
			A100 03 220 0450	A110 03 220 0450	4,0X45
			A100 03 220 0500	A110 03 220 0500	4,0X50
			A100 03 220 0550	A110 03 220 0550	4,0X55
			A100 03 220 0600	A110 03 220 0600	4,0X60

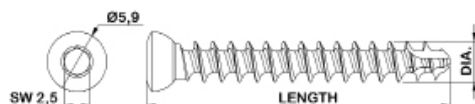

4,0 mm Cancellous Bone Screw Partially Threaded



SS	TI	DIA. x LENGTH (mm)
A100 03 021 0200	A110 03 021 0200	4,0X20
A100 03 021 0220	A110 03 021 0220	4,0X22
A100 03 021 0240	A110 03 021 0240	4,0X24
A100 03 021 0260	A110 03 021 0260	4,0X26
A100 03 021 0280	A110 03 021 0280	4,0X28
A100 03 021 0300	A110 03 021 0300	4,0X30
A100 03 021 0350	A110 03 021 0350	4,0X35
A100 03 021 0400	A110 03 021 0400	4,0X40
A100 03 021 0450	A110 03 021 0450	4,0X45
A100 03 021 0500	A110 03 021 0500	4,0X50
A100 03 021 0550	A110 03 021 0550	4,0X55
A100 03 021 0600	A110 03 021 0600	4,0X60



2,7 mm Cortical Screw



SS	TI	DIA. x LENGTH (mm)	SS	TI	DIA. x LENGTH (mm)
A100 03 217 0060	A110 03 222 0110	2,7X6	A100 03 217 0180	A110 03 222 0220	2,7X18
A100 03 217 0080	A110 03 222 0112	2,7X8	A100 03 217 0200	A110 03 222 0240	2,7X20
A100 03 217 0100	A110 03 222 0140	2,7X10	A100 03 217 0220	A110 03 222 0260	2,7X22
A100 03 217 0120	A110 03 222 0160	2,7X12	A100 03 217 0240	A110 03 222 0280	2,7X24
A100 03 217 0140	A110 03 222 0180	2,7X14	A100 03 217 0260	A110 03 222 0300	2,7X26
A100 03 217 0160	A110 03 222 0200	2,7X16	A100 03 217 0280	A110 03 222 0320	2,7X28
			A100 03 217 0300	A110 03 222 0340	2,7X30
			A100 03 217 0320	A110 03 222 0360	2,7X32
			A100 03 217 0340	A110 03 222 0380	2,7X34
			A100 03 217 0360	A110 03 222 0400	2,7X36
			A100 03 217 0380	A110 03 222 0420	2,7X38
			A100 03 217 0400	A110 03 222 0440	2,7X40

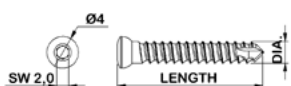

Small Fragment Non-Locking Screws

2,4 mm Cortical Screw



SS	TI	DIA. x LENGTH (mm)	SS	TI	DIA. x LENGTH (mm)
A100 03 213 0060	A110 03 222 0460	2,4X6	A100 03 213 0140	A110 03 222 0540	2,4X14
A100 03 213 0080	A110 03 222 0480	2,4X8	A100 03 213 0160	A110 03 222 0560	2,4X16
A100 03 213 0100	A110 03 222 0500	2,4X10	A100 03 213 0180	A110 03 222 0580	2,4X18
A100 03 213 0120	A110 03 222 0520	2,4X12	A100 03 213 0200	A110 03 222 0600	2,4X20
			A100 03 213 0220	A110 03 222 0620	2,4X22
			A100 03 213 0240	A110 03 222 0640	2,4X24
			A100 03 213 0260	A110 03 222 0650	2,4X26
			A100 03 213 0280	A110 03 222 0700	2,4X28
			A100 03 213 0300	A110 03 223 0100	2,4X30

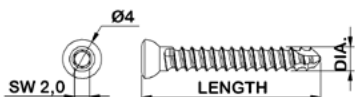

2,0 mm Cortical Screw



SS	DIA. x LENGTH (mm)	SS	DIA. x LENGTH (mm)
A100 03 216 0060	2,0X6	A100 03 216 0220	2,0X22
A100 03 216 0080	2,0X8	A100 03 216 0240	2,0X24
A100 03 216 0100	2,0X10	A100 03 216 0260	2,0X26
A100 03 216 0120	2,0X12	A100 03 216 0280	2,0X28
A100 03 216 0140	2,0X14	A100 03 216 0300	2,0X30
A100 03 216 0160	2,0X16	A100 03 216 0340	2,0X34
A100 03 216 0180	2,0X18	A100 03 216 0360	2,0X36
A100 03 216 0200	2,0X20	A100 03 216 0380	2,0X38

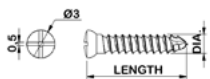

1,5 mm Cortical Screw



SS	DIA. x LENGTH (mm)	SS	DIA. x LENGTH (mm)
A100 03 215 0060	1,5X6	A100 03 215 0120	1,5X12
A100 03 215 0070	1,5X7	A100 03 215 0140	1,5X14
A100 03 215 0080	1,5X8	A100 03 215 0160	1,5X16
A100 03 215 0090	1,5X9	A100 03 215 0180	1,5X18
A100 03 215 0100	1,5X10	A100 03 215 0200	1,5X20

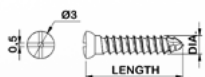

"We supply WORLD's
Orthopedic & Trauma
Implants..."

Large Fragment Plates

Locking/Non-Locking



Large Fragment Locking Plates

4,5/5,0 mm Proximal Femur Locking Compression Plate 1

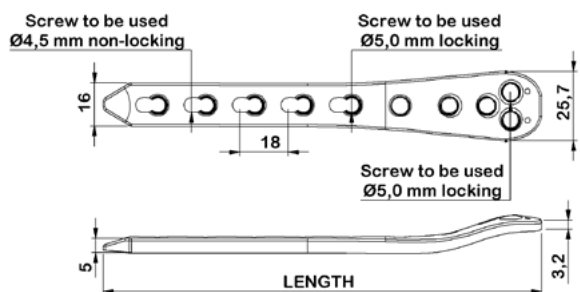

SS	TI	HOLES	SIDE	LENGTH (mm)
A1120903	A1120803	3	Left	91,0
A1120905	A1120805	5	Left	126,8
A1120907	A1120807	7	Left	162,8
A1120909	A1120809	9	Left	198,8
A1120911	A1120811	11	Left	234,8
A1120913	A1120813	13	Left	270,8
A1130903	A1130803	3	Right	91,0
A1130905	A1130805	5	Right	126,8
A1130907	A1130807	7	Right	162,8
A1130909	A1130809	9	Right	198,8
A1130911	A1130811	11	Right	234,8
A1130913	A1130813	13	Right	270,8

Intended use : Temporary fixation of fractures of the trochanteric region, fractures of the proximal femur, metastatic fractures of the proximal femur, osteotomies of the proximal femur and fixation of nonunions or malunions of proximal femur in adult patients.

4,5/5,0/7,3 mm Proximal Femur Locking Compression Plate 2

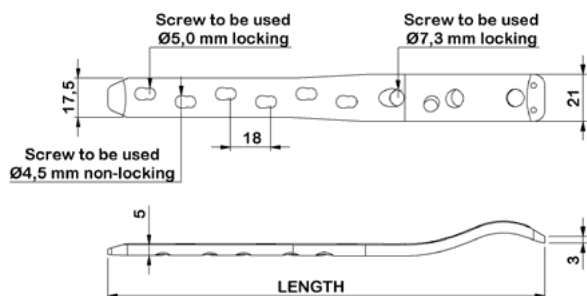
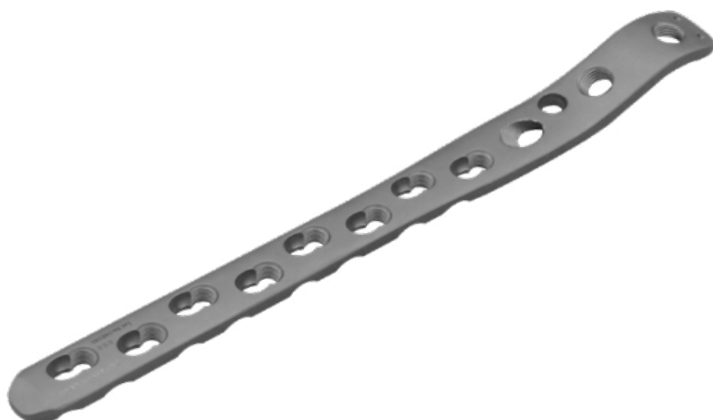

SS	TI	HOLES	SIDE	LENGTH (mm)
A1120902	A1120802	2	Left	119
A1120904	A1120804	4	Left	159
A1120906	A1120806	6	Left	195
A1120908	A1120808	8	Left	231
A1120910	A1120810	10	Left	267
A1130902	A1130802	2	Right	119
A1130904	A1130804	4	Right	159
A1130906	A1130806	6	Right	195
A1130908	A1130808	8	Right	231
A1130910	A1130914	10	Right	267

Intended use : Temporary fixation of fractures of the trochanteric region, fractures of the proximal femur, metastatic fractures of the proximal femur, osteotomies of the proximal femur and fixation of nonunions or malunions of proximal femur in adult patients.

Large Fragment Locking Plates

Proximal Femur Compression Plate 7,3 mm Cannulated Locking Screw



SS	TI	DIA. x LENGTH (mm)
A6696050	A6666050	7,3X50
A6696055	A6666055	7,3X55
A6696060	A6666060	7,3X60
A6696065	A6666065	7,3X65
A6696070	A6666070	7,3X70
A6696075	A6666075	7,3X75
A6696080	A6666080	7,3X80
A6696085	A6666085	7,3X85
A6696090	A6666090	7,3X90
A6696095	A6666095	7,3X95
A6696100	A6666100	7,3X100
A6696105	A6666105	7,3X105
A6696110	A6666110	7,3X110
A6696115	A6666115	7,3X115
A6696120	A6666120	7,3X120



Intended use : Temporary fixation of proximal femur fractures. Used only together with Proximal Femur Locking Compression Plate 2

4,5/5,0 mm Locking Plate Broad Curved

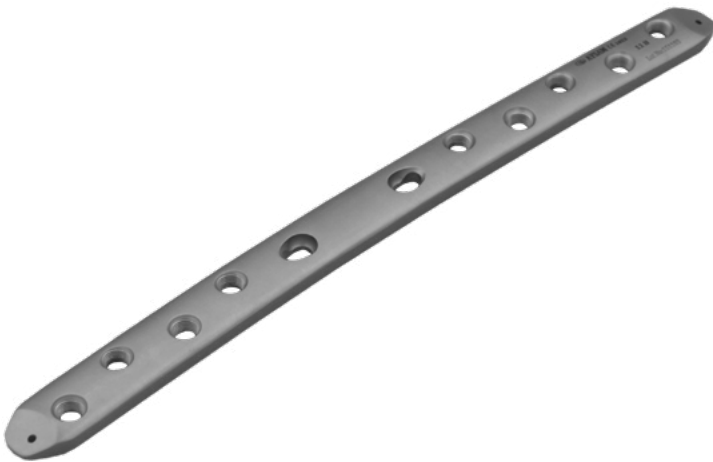

SS	TI	HOLES	LENGTH (mm)
A1871909	A1871809	9	195,4
A1871910	A1871810	10	212,7
A1871911	A1872811	11	230,5
A1871912	A1872812	12	248,4
A1871913	A1872813	13	265,7
A1871914	A1872814	14	282,9
A1871915	A1872815	15	300,7
A1871916	A1872816	16	318,5

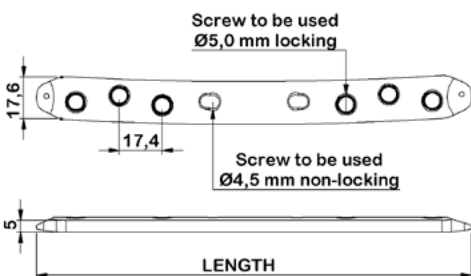

Intended use : Temporary fixation of fractures of femur shaft, fixation of periprosthetic fractures, fixation of nonunions or malunions of femur shaft in adult patients.

Large Fragment Locking Plates

4,5/5,0 mm Distal Lateral Femur Locking Plate 1



SS	TI	HOLES	SIDE	LENGTH (mm)
A1441905	A1441805	5	Left	156,4
A1441907	A1441807	7	Left	196,4
A1441909	A1441809	9	Left	236,4
A1441911	A1441811	11	Left	276,4
A1441913	A1441813	13	Left	316,4
A1452905	A1452805	5	Right	156,4
A1452907	A1452807	7	Right	196,4
A1452909	A1452809	9	Right	236,4
A1452911	A1452811	11	Right	276,4
A1452913	A1452813	13	Right	316,4

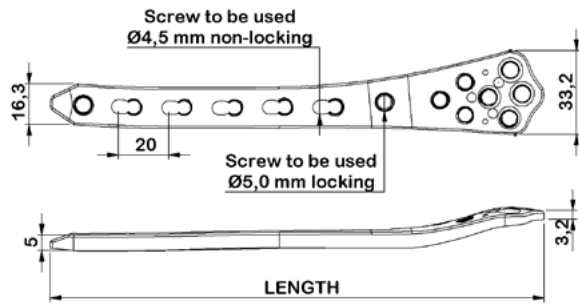

Intended use : Temporary fixation of fractures, osteotomies, nonunions or malunions of the distal femur (intercondylar, supracondylar, intra-extra articular) in adult patients. Those plates are used by lateral approach.

4,5/5,0 mm Distal Lateral Femur Locking Plate 2



SS	TI	HOLES	SIDE	LENGTH (mm)
A6729106	A6728106	6	Left	158
A6729107	A6728107	7	Left	174
A6729108	A6728108	8	Left	191
A6729109	A6728109	9	Left	206
A6729110	A6728110	10	Left	223
A6729112	A6728111	11	Left	250
A6729206	A6728206	6	Right	158
A6729207	A6728207	7	Right	174
A6729208	A6728208	8	Right	191
A6729209	A6728209	9	Right	206
A6729210	A6728210	10	Right	223
A6729211	A6728211	11	Right	250

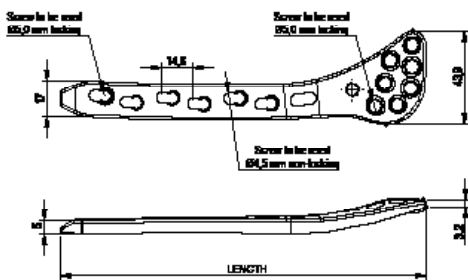

Intended use : Temporary fixation of fractures, osteotomies, nonunions or malunions of the distal femur (intercondylar, supracondylar, intra-extra articular) in adult patients. Those plates are used by lateral approach.

Large Fragment Locking Plates

4,5/5,0 mm Distal Medial Femur Locking Plate



SS	TI	HOLES	SIDE	LENGTH (mm)
A6739104	A6738104	4	Left	115,9
A6739106	A6738106	6	Left	147,9
A6739108	A6738108	8	Left	179,9
A6739110	A6738110	10	Left	211,9
A6739204	A6738204	4	Right	115,9
A6739206	A6738206	6	Right	147,9
A6739208	A6738208	8	Right	179,9
A6739210	A6738210	10	Right	211,9

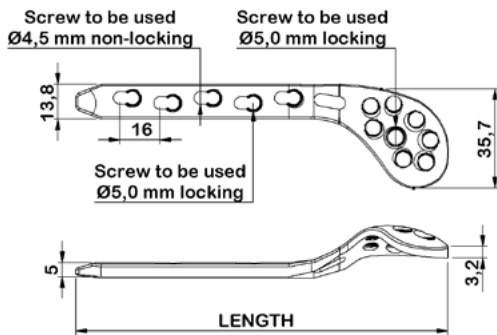

Intended use : Temporary fixation of fractures, osteotomies, nonunions or malunions of the distal femur (intercondylar, supracondylar, intra-extra articular) in adult patients. Those plates are used by medial approach.

4,5/5,0 mm Condylar Femur Locking Plate



SS	TI	HOLES	SIDE	LENGTH (mm)
A6749106	A6748106	6	Left	149,1
A6749108	A6748108	8	Left	181,1
A6749110	A6748110	10	Left	213,1
A6749112	A6748112	12	Left	245,1
A6749206	A6748206	6	Right	149,1
A6749208	A6748208	8	Right	181,1
A6749210	A6748210	10	Right	213,1
A6749212	A6748212	12	Right	245,1

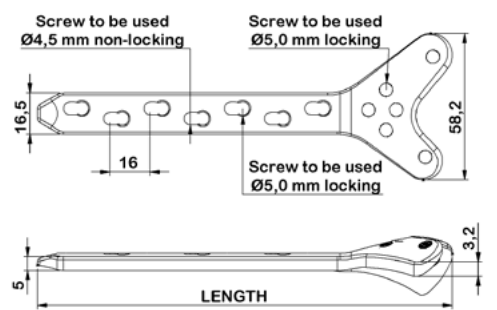

Intended use : Temporary fixation of fractures, osteotomies, nonunions or malunions of the distal femur (intercondylar, supracondylar, intra-extra articular) in adult patients. Those plates are used by lateral approach.

Large Fragment Locking Plates

4,5/5,0 mm Proximal Lateral Tibia Locking Plate 1



SS	TI	HOLES	SIDE	LENGTH (mm)
A1461905	A1461805	5	Left	143,3
A1461907	A1461807	7	Left	183,3
A1461909	A1461809	9	Left	223,3
A1461911	A1461811	11	Left	263,3
A1461913	A1461813	13	Left	303,3
A1472905	A1472805	5	Right	143,3
A1472907	A1472807	7	Right	183,3
A1472909	A1472809	9	Right	223,3
A1472911	A1472811	11	Right	263,3
A1472913	A1472813	13	Right	303,3

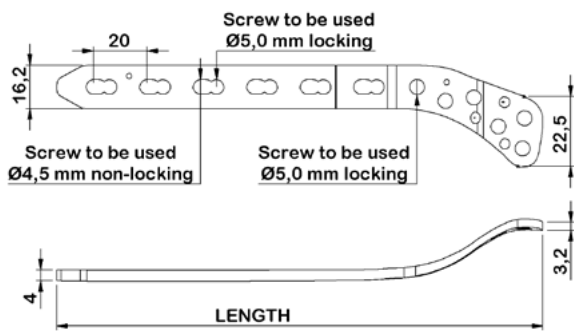

Intended use : Temporary fixation of fractures, osteotomies, nonunions or malunions of the proximal tibia in adult patients. Those plates are used by medial approach.

4,5/5,0 mm Proximal Lateral Tibia Locking Plate 2

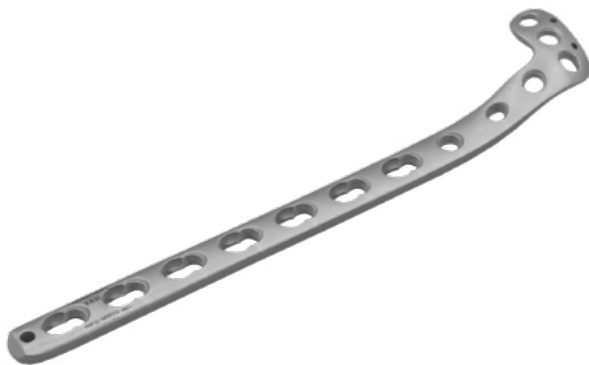

SS	TI	HOLES	SIDE	LENGTH (mm)
A9461905	A9461805	5	Left	102
A9461907	A9461807	7	Left	138
A9461909	A9461809	9	Left	174
A9461911	A9461811	11	Left	210
A9461913	A9461813	13	Left	246
A9472905	A9472805	5	Right	102
A9472907	A9472807	7	Right	138
A9472909	A9472809	9	Right	174
A9472911	A9472811	11	Right	210
A9472913	A9472813	13	Right	246

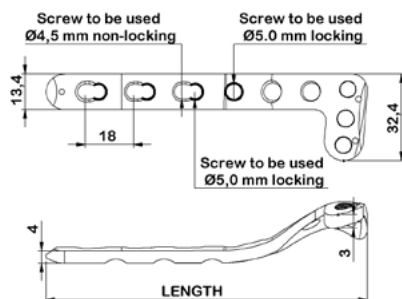

Intended use : Temporary fixation of fractures, osteotomies, nonunions or malunions of the proximal tibia in adult patients. Those plates are used by lateral approach.

Large Fragment Locking Plates

4,5/5,0 mm Proximal Medial Tibia Locking Plate



SS	TI	HOLES	SIDE	LENGTH (mm)
A5599104	A5598104	4	Left	90,6
A5599106	A5598106	6	Left	122,6
A5599108	A5598108	8	Left	154,6
A5599110	A5598110	10	Left	186,6
A5599112	A5598112	12	Left	218,6
A5599204	A5598204	4	Right	90,6
A5599206	A5598206	6	Right	122,6
A5599208	A5598208	8	Right	154,6
A5599210	A5598210	10	Right	186,6
A5599212	A5598212	12	Right	218,6

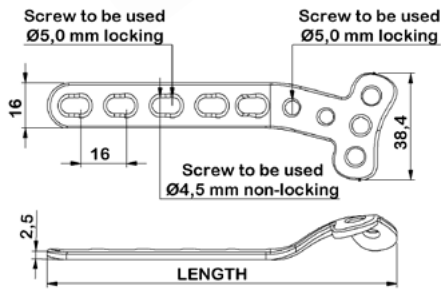

Intended use : Temporary fixation of fractures, osteotomies, nonunions or malunions of the proximal tibia in adult patients. Those plates are used by medial approach.

4,5/5,0 mm Locking Compression L-Plate



SS	TI	HOLES	SIDE	LENGTH (mm)
A1561903	A1561803	3	Left	65,1
A1561904	A1561804	4	Left	81,1
A1561905	A1561805	5	Left	97,1
A1561906	A1561806	6	Left	113,1
A1561907	A1561807	7	Left	129,1
A1561908	A1561808	8	Left	145,1
A1572903	A1572803	3	Right	65,1
A1572904	A1572804	4	Right	81,1
A1572905	A1572805	5	Right	97,1
A1572906	A1572806	6	Right	113,1
A1572907	A1572807	7	Right	129,1
A1572908	A1572808	8	Right	145,1

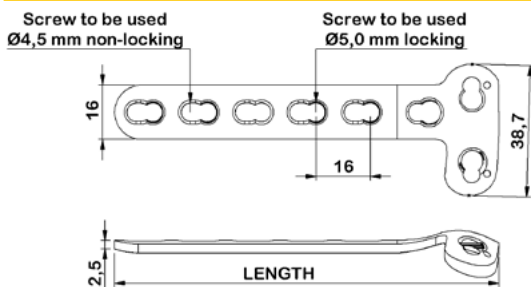

Intended use : Temporary fixation of fractures, osteotomies, nonunions or malunions of the proximal tibia in adult patients.

Large Fragment Locking Plates

4,5/5,0 mm Locking Compression T-Plate



SS	TI	HOLES	LENGTH (mm)
A1490904	A1490804	4	81,7
A1490905	A1490805	5	97,7
A1490906	A1490806	6	113,7
A1490907	A1490807	7	129,7
A1490908	A1490808	8	145,7

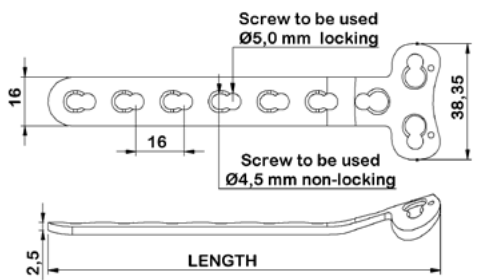

Intended use : Temporary fixation of fractures, osteotomies, nonunions or malunions of the proximal tibia in adult patients.

3,5/4,5/5,0 mm Metaphysis Locking Compression Plate

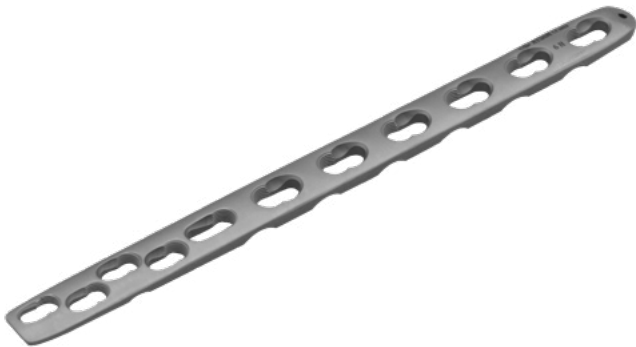

SS	TI	HOLES	LENGTH (mm)
A1850903	A1850803	3	118
A1850904	A1850804	4	136
A1850905	A1850805	5	154
A1850906	A1850806	6	172
A1850907	A1850807	7	190
A1850908	A1850808	8	208
A1850909	A1850809	9	226
A1850911	A1850811	11	262

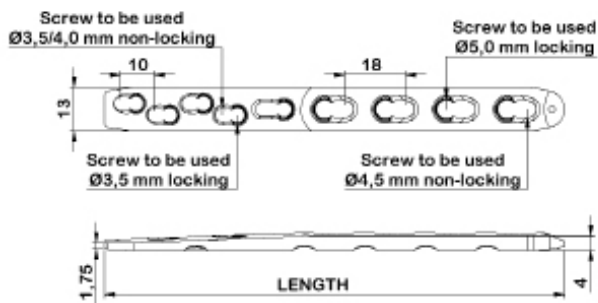

Intended use : Temporary fixation of extra-articular fractures, osteotomies, nonunions or malunions of the metaphyseal area of distal tibia, distal & proximal humerus that extend into the shaft.

Large Fragment Locking Plates

4,5/5,0 mm Narrow Locking Compression Plate



SS	TI	HOLES	LENGTH (mm)
A1821105	A1820905	5	110,6
A1821106	A1820906	6	128,6
A1821107	A1820907	7	146,6
A1821108	A1820908	8	164,6
A1821109	A1820909	9	182,6
A1821110	A1820910	10	200,6
A1821111	A1820911	11	218,6
A1821112	A1820912	12	236,6
A1830816	A1820913	13	254,6
A1821114	A1820914	14	272,6

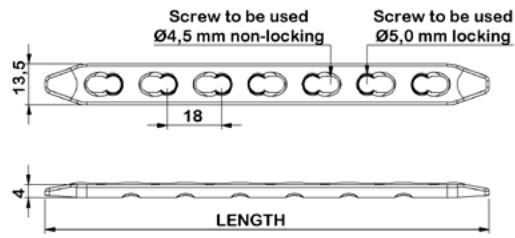

Intended use : Temporary fixation of fractures, osteotomies, nonunions and malunions, pseudoarthroses of the humerus, tibia, femur in adult patients and adolescent patients.

Attachment Locking Plate Medium



TI	TYPE	LENGTH (mm)
A110 02 190 0007	Medium	34,0

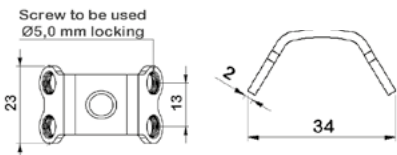

Intended use : For augmented Fixation of fractures, used as an attachment of 4,5/5,0 mm Narrow Locking Compression Plates.

4,5/5,0 mm Broad Locking Compression Plate



SS	TI	HOLES	LENGTH (mm)
A1830905	A1830805	5	109
A1830906	A1830806	6	127
A1830907	A1830807	7	145
A1830908	A1830808	8	163
A1830909	A1830809	9	181
A1830910	A1830810	10	199
A1830911	A1830811	11	217
A1830912	A1830812	12	235
A1830913	A1830813	13	253
A1830914	A1830814	14	271

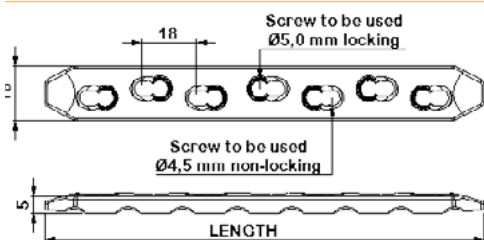

Intended use : Temporary fixation of fractures, osteotomies, nonunions and malunions of the femur. Those plates are used by lateral approach.

Large Fragment Locking Plates

Attachment Locking Plate Large



TI	TYPE	LENGTH (mm)
A110 02 190 0008	Large	41.8

Intended use : For augmented Fixation of fractures, used as an attachment of 4,5/5,0 mm Broad Locking Compression Plates.

4,5/5,0 mm Distal Tibia Antrolateral Locking Plate 1

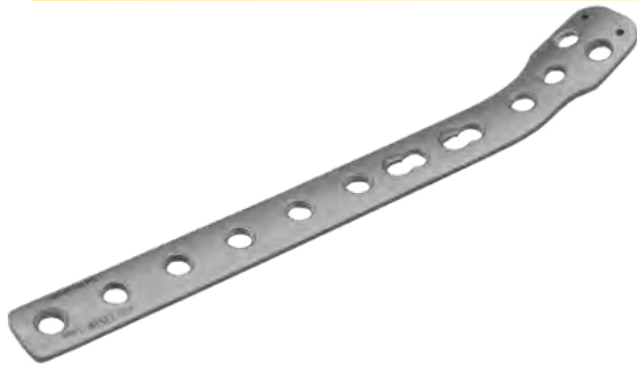

SS	TI	HOLES	SIDE	LENGTH (mm)
A1261905	A1261805	5	Left	108,3
A1261907	A1261807	7	Left	140,3
A1261909	A1261809	9	Left	172,3
A1261911	A1261811	11	Left	204,3
A1261913	A1261813	13	Left	236,3
A1261915	A1261815	15	Left	268,3
A1272905	A1272805	5	Right	108,3
A1272907	A1272807	7	Right	140,3
A1272909	A1272809	9	Right	172,3
A1272911	A1272811	11	Right	204,3
A1272913	A1272813	13	Right	236,3
A1272915	A1272815	15	Right	268,3

Intended use : Temporary fixation of fractures, osteotomies, nonunions and malunions of the distal tibia. Those plates are used by anterolateral approach.

3,5/4,0 mm Distal Tibia Antrolateral Locking Plate 2

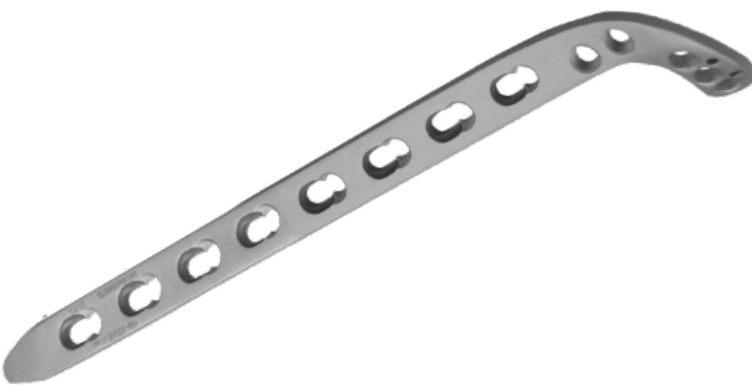

SS	TI	HOLES	SIDE	LENGTH (mm)
A1431905	A1431805	5	Left	89,8
A1431907	A1431807	7	Left	119,8
A1431909	A1431809	9	Left	149,8
A1431911	A1431811	11	Left	179,8
A1431913	A1431813	13	Left	209,8
A1431915	A1431815	15	Left	239,8
A1431917	A1431817	17	Left	269,8
A1432905	A1432805	5	Right	89,8
A1432907	A1432807	7	Right	119,8
A1432909	A1432809	9	Right	149,8
A1432911	A1432811	11	Right	179,8
A1432913	A1432813	13	Right	209,8
A1432915	A1432815	15	Right	239,8
A1432917	A1432817	17	Right	269,8

Intended use : Temporary fixation of fractures, osteotomies, nonunions and malunions of the distal tibia. Those plates are used by anterolateral approach.

Large Fragment Locking Plates

3,5/4,0 mm Distal Medial Tibia Locking Compression Plate 1

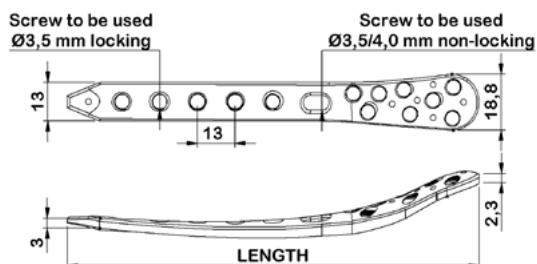
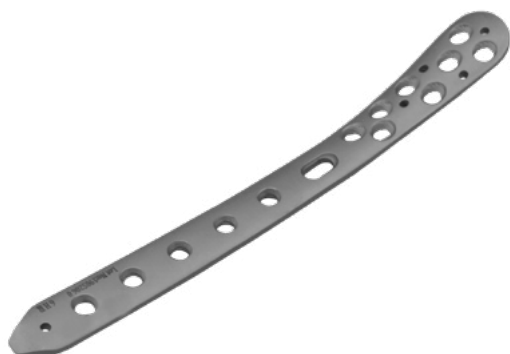

SS	TI	HOLES	SIDE	LENGTH (mm)
A1381904	A1381804	4	Left	116
A1381906	A1381806	6	Left	142
A1381908	A1381808	8	Left	168
A1381910	A1381810	10	Left	194
A1381912	A1381812	12	Left	220
A1381914	A1381814	14	Left	246
A1392904	A1392804	4	Right	116
A1392906	A1392806	6	Right	142
A1392908	A1392808	8	Right	168
A1392910	A1392810	10	Right	194
A1392912	A1392812	12	Right	220
A1392914	A1392814	14	Right	246

Intended use : Temporary fixation of fractures, osteotomies, nonunions and malunions of the distal tibia. Those plates are used by medial approach.

3,5/4,0 mm Distal Medial Tibia Locking Compression Plate 2

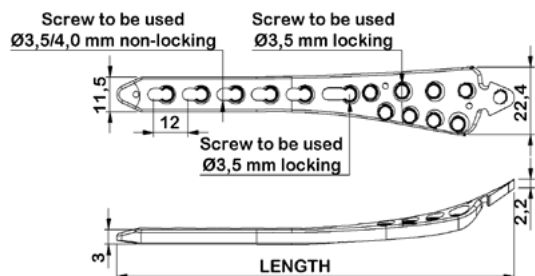

SS	TI	HOLES	SIDE	LENGTH (mm)
A1401906	A1401806	6	Left	137,9
A1401908	A1401808	8	Left	161,9
A1401910	A1401810	10	Left	185,9
A1401912	A1401812	12	Left	209,9
A1401914	A1401814	14	Left	233,9
A1412906	A1412806	6	Right	137,9
A1412908	A1412808	8	Right	161,9
A1412910	A1412810	10	Right	185,9
A1412912	A1412812	12	Right	209,9
A1412914	A1412814	14	Right	233,9

Intended use : Temporary fixation of fractures, osteotomies, nonunions and malunions of the distal tibia. Those plates are used by medial approach.

Large Fragment Locking Plates

3,5/4,0 mm Distal Tibia Locking Pilon Plate

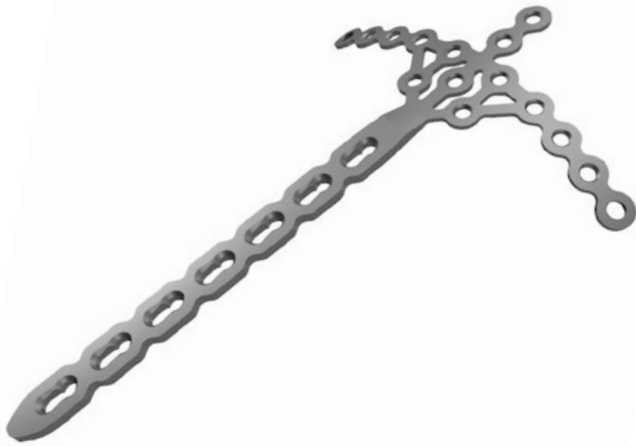

SS	TI	HOLES	LENGTH (mm)
A1411816	A1401816	16	111,5
A1411818	A1401818	18	142,5
A1411820	A1401820	20	173,5
A1411822	A1401822	22	204,5
A1411824	A1401824	24	235,5
A1411826	A1401826	26	266,5

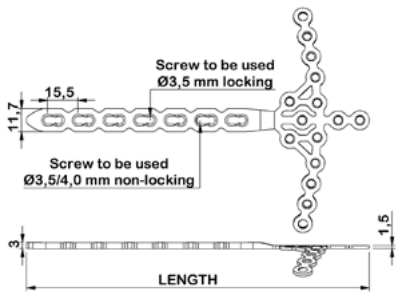

Intended use : Temporary fixation of fractures, osteotomies, nonunions and malunions of the distal articular fractures of the tibia (pilon fractures) with emphasis on complex articular reconstruction.

3,5/4,0 mm Distal Fibula Locking Plate 1

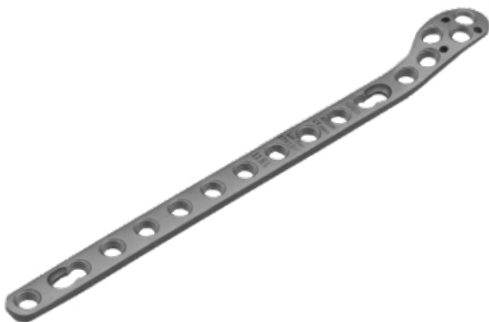

SS	TI	HOLES	SIDE	LENGTH (mm)
A5097103	A5096103	3	Left	71
A5097104	A5096104	4	Left	81
A5097105	A5096105	5	Left	91
A5097106	A5096106	6	Left	101
A5097107	A5096107	7	Left	111
A5097108	A5096108	8	Left	121
A5097109	A5096109	9	Left	131
A5097110	A5096110	10	Left	141
A5097111	A5096111	11	Left	151
A5097112	A5096112	12	Left	161
A5097203	A5096203	3	Right	71
A5097204	A5096204	4	Right	81
A5097205	A5096205	5	Right	91
A5097206	A5096206	6	Right	101
A5097207	A5096207	7	Right	111
A5097208	A5096208	8	Right	121
A5097209	A5096209	9	Right	131
A5097210	A5096210	10	Right	141
A5097211	A5096211	11	Right	151
A5097212	A5096212	12	Right	161

Intended use : Temporary fixation of fractures, osteotomies and nonunions of the metaphyseal and diaphyseal region of the distal fibula.

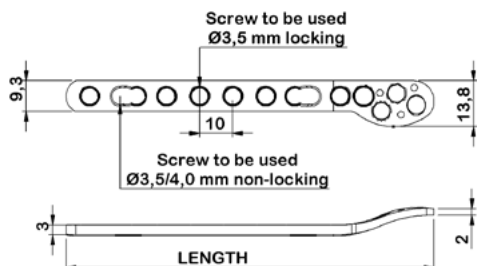

Large Fragment Locking Plates

2,7/3,5/4,0 mm Distal Fibula Locking Plate 2

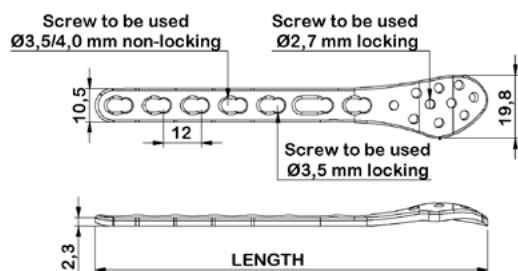

Intended use : Temporary fixation of fractures, osteotomies and nonunions of the metaphyseal and diaphyseal region of the distal fibula.

SS	TI	HOLES	SIDE	LENGTH (mm)
A14319913	A14318813	3	Left	75,5
A14319914	A14318814	4	Left	87,5
A14319905	A14318805	5	Left	99,5
A14319906	A14318806	6	Left	111,5
A14319907	A14318807	7	Left	123,5
A14319908	A14318808	8	Left	135,5
A14319909	A14318809	9	Left	147,5
A14319910	A14318810	10	Left	159,5
A14319911	A14318811	11	Left	171,5
A14319912	A14318812	12	Left	183,5
A14329913	A14328813	3	Right	75,5
A14329914	A14328814	4	Right	87,5
A14329905	A14328805	5	Right	99,5
A14329906	A14328806	6	Right	111,5
A14329907	A14328807	7	Right	123,5
A14329908	A14328808	8	Right	135,5
A14329909	A14328809	9	Right	147,5
A14329910	A14328810	10	Right	159,5
A14329911	A14328811	11	Right	171,5
A14329912	A14328812	12	Right	183,5

4,0/4,5/5,0 mm Reconstruction Locking Compression Plate

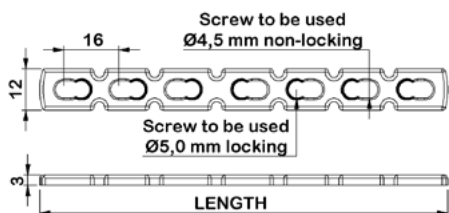

Intended use : Temporary fixation of fractures, osteotomies, nonunions and malunions of large bones, including pelvis, femur, tibia & humerus in Adult patients.

SS	TI	HOLES	LENGTH (mm)
A1810905	A1810805	5	86
A1810906	A1810806	6	102
A1810907	A1810807	7	118
A1810908	A1810808	8	134
A1810909	A1810809	9	150
A1810910	A1810810	10	166
A1810912	A1810812	12	198

Large Fragment Locking Plates

4,0/4,5/5,0 mm Curved Reconstruction Locking Plate



SS	TI	HOLES	LENGTH (mm)
A101 02 228 0002	A111 02 228 0002	2	30
A101 02 228 0003	A111 02 228 0003	3	45
A101 02 228 0004	A111 02 228 0004	4	61
A101 02 228 0005	A111 02 228 0005	5	78
A101 02 228 0006	A111 02 228 0006	6	94
A101 02 228 0007	A111 02 228 0007	7	109
A101 02 228 0008	A111 02 228 0008	8	125
A101 02 228 0009	A111 02 228 0009	9	140
A101 02 228 0010	A111 02 228 0010	10	155
A101 02 228 0011	A111 02 228 0011	11	169
A101 02 228 0012	A111 02 228 0012	12	184

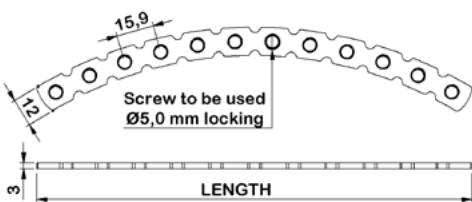

Intended use : Temporary fixation of fractures, osteotomies, malunions and non-unions of pelvis.

3,5 mm Calcaneal Locking Plate 1

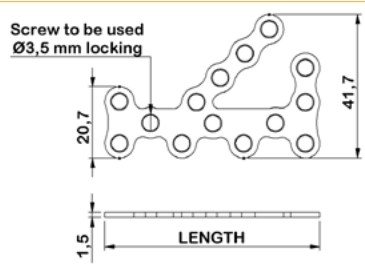

SS	TI	SIDE	LENGTH (mm)
A5989100	A5988100	Left	62,6
A5989101	A5988101	Right	62,6

Intended use : Temporary fixation of fractures, osteotomies, malunions and nonunions of calcaneus in adult & skeletally mature adolescents.

3,5 mm Calcaneal Locking Plate 2

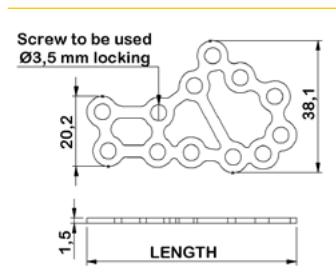

SS	TI	SIDE	LENGTH (mm)
A5999100	A5998100	Left	60,5
A5999101	A5998101	Right	60,5

Intended use : Temporary fixation of fractures, osteotomies, malunions and nonunions of calcaneus in adult & skeletally mature adolescents.

Large Fragment Locking Plates

3,5 mm Calcaneal Locking Plate 3

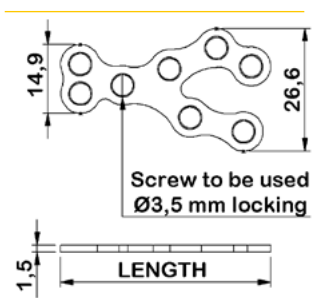

SS	TI	SIDE	LENGTH (mm)
A5979100	A5978100	Left	45,7
A5979101	A5978101	Right	45,7

Intended use : Temporary fixation of fractures, osteotomies, malunions and nonunions of calcaneus in adult & skeletally mature adolescents.

3,5 mm Calcaneal Locking Plate 4

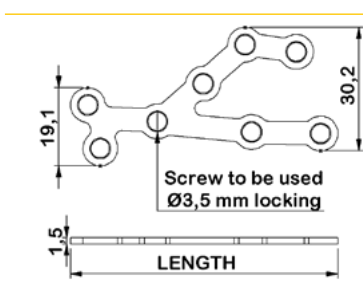

SS	TI	SIDE	LENGTH (mm)
A5969100	A5968100	Left	65,6
A5969101	A5968101	Right	65,6

Intended use : Temporary fixation of fractures, osteotomies, malunions and nonunions of calcaneus in adult & skeletally mature adolescents.

3,5 mm Calcaneal Locking Plate 5

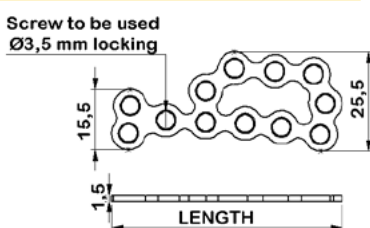
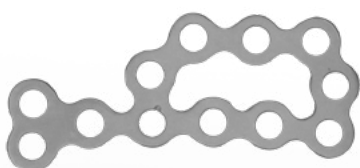

SS	TI	SIDE	LENGTH (mm)
A5959100	A5958100	Left	59,1
A5959101	A5958101	Right	59,1

Intended use : Temporary fixation of fractures, osteotomies, malunions and nonunions of calcaneus in adult & skeletally mature adolescents.



Large Fragment Non-Locking Plates

4,5 mm Proximal Femur Compression Plate 1

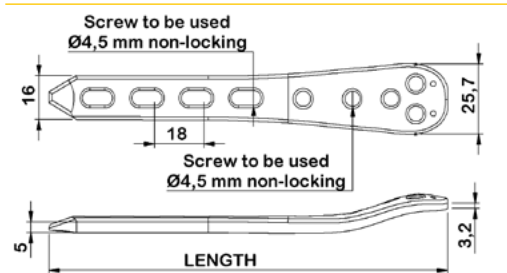

SS	TI	HOLES	SIDE	LENGTH (mm)
A100 02 252 0005	A110 02 252 0005	5	Left	126,8
A100 02 252 0007	A110 02 252 0007	7	Left	162,8
A100 02 252 0009	A110 02 252 0009	9	Left	198,8
A100 02 252 0011	A110 02 252 0011	11	Left	234,8
A100 02 252 0013	A110 02 252 0013	13	Left	270,8
A100 02 253 0005	A110 02 253 0005	5	Right	126,8
A100 02 253 0007	A110 02 253 0007	7	Right	162,8
A100 02 253 0009	A110 02 253 0009	9	Right	198,8
A100 02 253 0011	A110 02 253 0011	11	Right	234,8
A100 02 253 0013	A110 02 253 0013	13	Right	270,8

Intended use : Temporary fixation of fractures of the trochanteric region, fractures of the proximal femur, metastatic fractures of the proximal femur, osteotomies of the proximal femur and fixation of nonunions or malunions of proximal femur in adult patients.

4,5 mm Distal Lateral Femur Plate 1

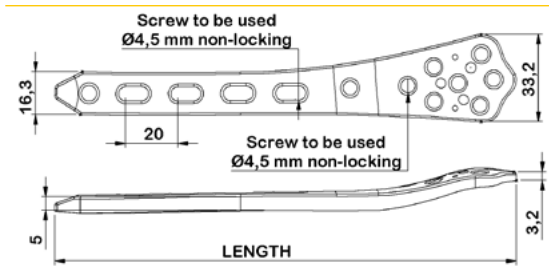

SS	TI	HOLES	SIDE	LENGTH (mm)
A100 02 245 0005	A110 02 245 0005	5	Left	156,4
A100 02 245 0007	A110 02 245 0007	7	Left	196,4
A100 02 245 0009	A110 02 245 0009	9	Left	236,4
A100 02 245 0011	A110 02 245 0011	11	Left	276,4
A100 02 245 0013	A110 02 245 0013	13	Left	306,4
A100 02 246 0005	A110 02 246 0005	5	Right	156,4
A100 02 246 0007	A110 02 246 0007	7	Right	196,4
A100 02 246 0009	A110 02 246 0009	9	Right	236,4
A100 02 246 0011	A110 02 246 0011	11	Right	276,4
A100 02 246 0013	A110 02 246 0013	13	Right	306,4

Intended use : Temporary fixation of fractures, osteotomies, nonunions or malunions of the distal femur (intercondylar, supracondylar, intra-extra articular) in adult patients. Those plates are used by lateral approach.

Large Fragment Non-Locking Plates

4,5 mm Distal Lateral Femur Plate 2

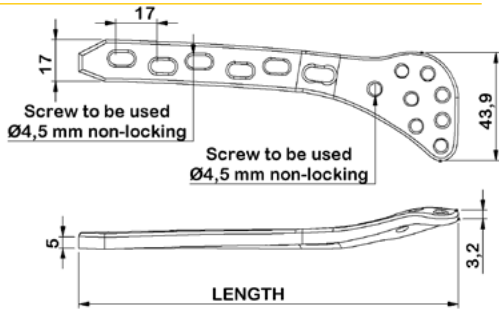

Intended use : Temporary fixation of fractures, osteotomies, nonunions or malunions of the distal femur (intercondylar, supracondylar, intra-extra articular) in adult patients. Those plates are used by lateral approach.

SS	TI	HOLES	SIDE	LENGTH (mm)
A5729106	A5728106	6	Left	158
A5729107	A5728107	7	Left	174
A5729108	A5728108	8	Left	191
A5729109	A5728109	9	Left	206
A5729110	A5728110	10	Left	223
A5729112	A5728112	12	Left	250
A5729206	A5728206	6	Right	158
A5729207	A5728207	7	Right	174
A5729208	A5728208	8	Right	191
A5729209	A5728209	9	Right	206
A5729210	A5728210	10	Right	223
A5729212	A5728212	12	Right	250

4,5/6,5 mm Femur Condylar Buttress Plate

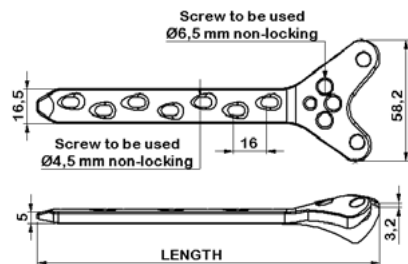

Intended use : Temporary fixation of fractures, osteotomies, nonunions or malunions of the distal femur (intercondylar, supracondylar, intra-extra articular) in adult patients. Those plates are used by lateral approach.

SS	TI	HOLES	SIDE	LENGTH (mm)
A100 02 185 0005	A110 02 185 0005	5	Left	133
A100 02 185 0006	A110 02 185 0006	6	Left	149
A100 02 185 0007	A110 02 185 0007	7	Left	165
A100 02 185 0008	A110 02 185 0008	8	Left	181
A100 02 185 0009	A110 02 185 0009	9	Left	197
A100 02 185 0010	A110 02 185 0010	10	Left	213
A100 02 185 0011	A110 02 185 0011	11	Left	229
A100 02 185 0012	A110 02 185 0012	12	Left	245
A100 02 185 0013	A110 02 185 0013	13	Left	264
A100 02 185 0014	A110 02 185 0014	14	Left	277
A100 02 185 0015	A110 02 185 0015	15	Left	293
A100 02 186 0005	A110 02 186 0005	5	Right	133
A100 02 186 0006	A110 02 186 0006	6	Right	149
A100 02 186 0007	A110 02 186 0007	7	Right	165
A100 02 186 0008	A110 02 186 0008	8	Right	181
A100 02 186 0009	A110 02 186 0009	9	Right	197
A100 02 186 0010	A110 02 186 0010	10	Right	213
A100 02 186 0011	A110 02 186 0011	11	Right	229
A100 02 186 0012	A110 02 186 0012	12	Right	245
A100 02 186 0013	A110 02 186 0013	13	Right	264
A100 02 186 0014	A110 02 186 0014	14	Right	277
A100 02 186 0015	A110 02 186 0015	15	Right	293

Large Fragment Non-Locking Plates

4,5 mm Distal Medial Femur Buttress Plate



SS	TI	HOLES	SIDE	LENGTH (mm)
A5739104	A5738104	4	Left	115,9
A5739106	A5738106	6	Left	147,9
A5739108	A5738108	8	Left	179,9
A5739204	A5738204	4	Right	115,9
A5739206	A5738206	6	Right	147,9
A5739208	A5738208	8	Right	179,9

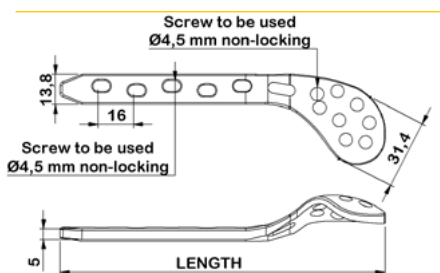

Intended use : Temporary fixation of fractures, osteotomies, nonunions or malunions of the distal femur (intercondylar, supracondylar, intra-extra articular) in adult patients. Those plates are used by medial approach.

4,5/6,5 mm Broad Compression Plate

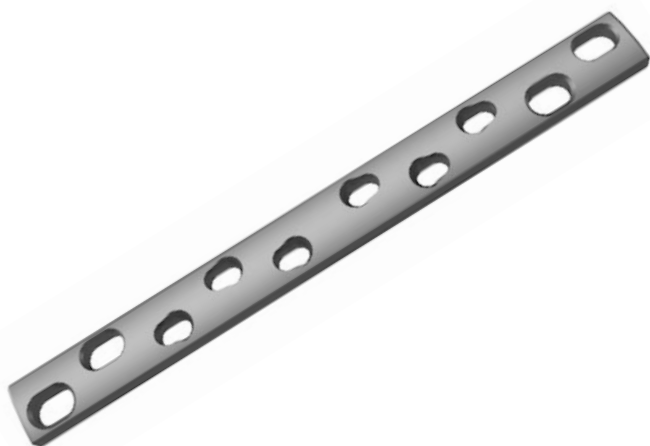

SS	TI	HOLES	LENGTH (mm)
A100 02 161 0004	A110 02 161 0004	4	71
A100 02 161 0005	A110 02 161 0005	5	87
A100 02 161 0006	A110 02 161 0006	6	103
A100 02 161 0007	A110 02 161 0007	7	119
A100 02 161 0008	A110 02 161 0008	8	135
A100 02 161 0009	A110 02 161 0009	9	151
A100 02 161 0010	A110 02 161 0010	10	167
A100 02 161 0011	A110 02 161 0011	11	183
A100 02 161 0012	A110 02 161 0012	12	199
A100 02 161 0013	A110 02 161 0013	13	215
A100 02 161 0014	A110 02 161 0014	14	231
A100 02 161 0015	A110 02 161 0015	15	247
A100 02 161 0016	A110 02 161 0016	16	263
A100 02 161 0017	A110 02 161 0017	17	279
A100 02 161 0018	A110 02 161 0018	18	295

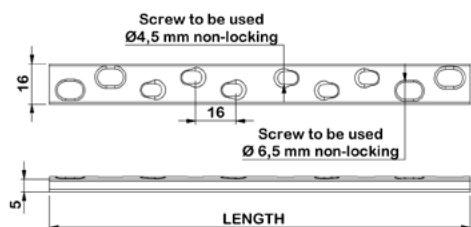

Intended use : Temporary fixation of fractures, malunions, nonunions, osteotomies and pseudoarthroses of the femur.

Large Fragment Non-Locking Plates

4,5/6,5 mm Narrow Compression Plate



SS	TI	HOLES	LENGTH (mm)
A100 02 151 0002	A110 02 151 0002	2	39
A100 02 151 0003	A110 02 151 0003	3	55
A100 02 151 0004	A110 02 151 0004	4	71
A100 02 151 0005	A110 02 151 0005	5	87
A100 02 151 0006	A110 02 151 0006	6	103
A100 02 151 0007	A110 02 151 0007	7	119
A100 02 151 0008	A110 02 151 0008	8	135
A100 02 151 0009	A110 02 151 0009	9	151
A100 02 151 0010	A110 02 151 0010	10	167
A100 02 151 0011	A110 02 151 0011	11	183
A100 02 151 0012	A110 02 151 0012	12	199
A100 02 151 0013	A110 02 151 0013	13	215
A100 02 151 0014	A110 02 151 0014	14	231
A100 02 151 0015	A110 02 151 0015	15	247
A100 02 151 0016	A110 02 151 0016	16	263

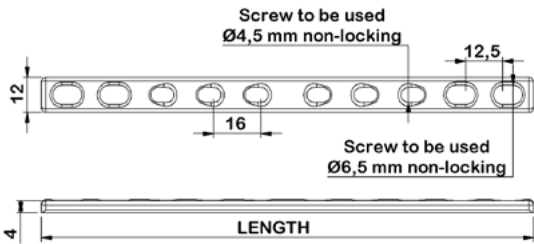

Intended use : Temporary fixation of fractures, malunions, nonunions, osteotomies and pseudoarthroses of the humerus and tibia.

4,5 mm Straight Reconstruction Plate

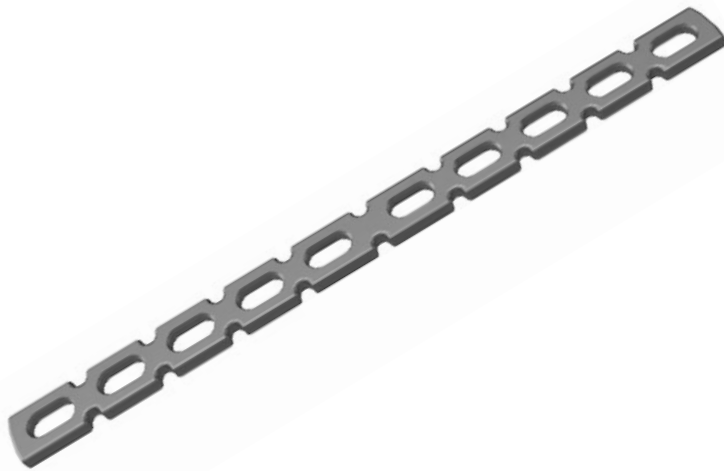

SS	TI	HOLES	LENGTH (mm)
A100 02 277 0004	A110 02 277 0004	4	71
A100 02 277 0005	A110 02 277 0005	5	87
A100 02 277 0006	A110 02 277 0006	6	103
A100 02 277 0007	A110 02 277 0007	7	119
A100 02 277 0008	A110 02 277 0008	8	135
A100 02 277 0009	A110 02 277 0009	9	151
A100 02 277 0010	A110 02 277 0010	10	167
A100 02 227 0011	A110 02 227 0011	11	183
A100 02 227 0012	A110 02 227 0012	12	199
A100 02 227 0013	A110 02 227 0013	13	215
A100 02 227 0014	A110 02 227 0014	14	231
A100 02 227 0015	A110 02 227 0015	15	247
A100 02 227 0016	A110 02 227 0016	16	263

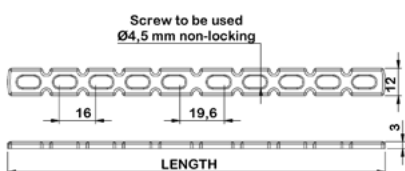

Intended use : Temporary fixation of fractures, osteotomies, nonunions and malunions of large bones, including pelvis, femur, tibia & humerus in Adult patients.

Large Fragment Non-Locking Plates

4,5 mm Curved Reconstruction Plate



SS	TI	HOLES	LENGTH (mm)
A100 02 228 0004	A110 02 228 0004	4	61,4
A100 02 228 0005	A110 02 228 0005	5	77,3
A100 02 228 0006	A110 02 228 0006	6	93,2
A100 02 228 0007	A110 02 228 0007	7	108,9
A100 02 228 0008	A110 02 228 0008	8	124,7
A100 02 228 0009	A110 02 228 0009	9	139,8
A100 02 228 0010	A110 02 228 0010	10	154,9
A100 02 228 0011	A110 02 228 0011	11	169,6
A100 02 228 0012	A110 02 228 0012	12	184
A100 02 228 0013	A110 02 228 0013	13	198
A100 02 228 0014	A110 02 228 0014	14	211,6
A100 02 228 0015	A110 02 228 0015	15	224,7
A100 02 228 0016	A110 02 228 0016	16	237,5

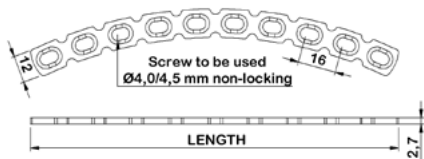

Intended use : Temporary fixation of fractures, malunions, nonunions, osteotomies of the pelvis.

4,5 mm Semi Tubular Plate



SS	TI	HOLES	LENGTH (mm)
A100 02 180 0004	A110 02 180 0004	4	71
A100 02 180 0005	A110 02 180 0005	5	87
A100 02 180 0006	A110 02 180 0006	6	103
A100 02 180 0007	A110 02 180 0007	7	119
A100 02 180 0008	A110 02 180 0008	8	135
A100 02 180 0009	A110 02 180 0009	9	151
A100 02 180 0010	A110 02 180 0010	10	167
A100 02 180 0011	A110 02 180 0011	11	183
A100 02 180 0012	A110 02 180 0012	12	231

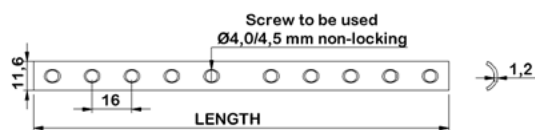

Intended use : Temporary fixation of fractures, malunions, nonunions, osteotomies of the fibula, ulna, radius.

Large Fragment Non-Locking Plates

4,5 mm Spoon Plate



SS	HOLES	LENGTH (mm)
A100 02 260 0005	5	101,4
A100 02 260 0006	6	120,6

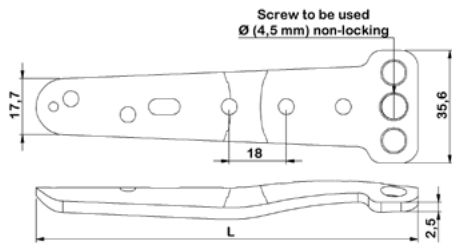

Intended use : Temporary fixation of fractures, malunions, nonunions, osteotomies of proximal and distal tibia.

4,5/6,5 mm Cobra Head Plate



SS	HOLES	LENGTH (mm)
A200 02 180 0006	6	143
A200 02 180 0007	7	159
A200 02 180 0008	8	175
A200 02 180 0009	9	191
A200 02 180 0010	10	207
A200 02 180 0011	11	223
A200 02 180 0012	12	239
A200 02 180 0013	13	255

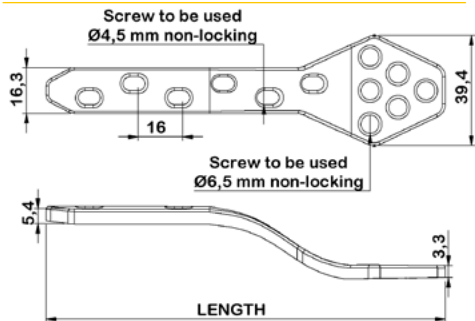

Intended use : Temporary fixation for the purpose of hip arthrodesis.

Large Fragment Non-Locking Plates

4,5/6,5 mm T-Buttress Plate



SS	TI	HOLES	LENGTH (mm)
A101 02 190 0003	A111 02 190 0003	3	63,5
A101 02 190 0004	A111 02 190 0004	4	79,5
A101 02 190 0005	A111 02 190 0005	5	95,5
A101 02 190 0006	A111 02 190 0006	6	111,5
A101 02 190 0007	A111 02 190 0007	7	127,5
A101 02 190 0008	A111 02 190 0008	8	143,5

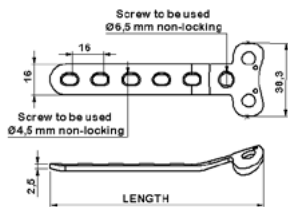

Intended use : Temporary fixation of fractures, malunions, nonunions, osteotomies of the proximal tibia in adult patients. Those plates are used both by medial and lateral approach.

4,5/6,5 mm L-Buttress Plate



SS	TI	HOLES	SIDE	LENGTH (mm)
A100 02 203 0003	A110 02 203 0003	3	Left	65,1
A100 02 203 0004	A110 02 203 0004	4	Left	81,1
A100 02 203 0005	A110 02 203 0005	5	Left	97,1
A100 02 203 0006	A110 02 203 0006	6	Left	113,1
A100 02 203 0007	A110 02 203 0007	7	Left	129,1
A100 02 203 0008	A110 02 203 0008	8	Left	145,1
A100 02 204 0003	A110 02 204 0003	3	Right	65,1
A100 02 204 0004	A110 02 204 0004	4	Right	81,1
A100 02 204 0005	A110 02 204 0005	5	Right	97,1
A100 02 204 0006	A110 02 204 0006	6	Right	113,1
A100 02 204 0007	A110 02 204 0007	7	Right	129,1
A100 02 204 0008	A110 02 204 0008	8	Right	145,1

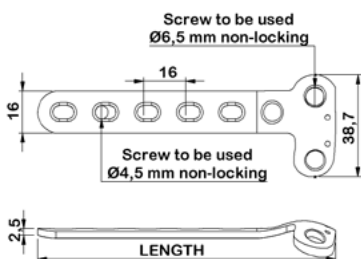

Intended use : Temporary fixation of fractures, malunions, nonunions, osteotomies of the proximal tibia in adult patients. Those plates are used both by medial and lateral approach.

Large Fragment Non-Locking Plates

4,5 mm Proximal Lateral Tibia Plate

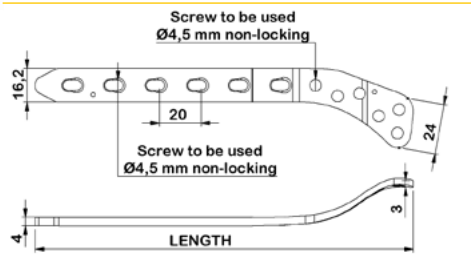

SS	TI	HOLES	SIDE	LENGTH (mm)
A100 02 256 0005	A110 02 256 0005	5	Left	141,8
A100 02 256 0007	A110 02 256 0007	7	Left	181,8
A100 02 256 0009	A110 02 256 0009	9	Left	221,8
A100 02 256 0011	A110 02 256 0011	11	Left	261,8
A100 02 256 0013	A110 02 256 0013	13	Left	301,8
A100 02 257 0005	A110 02 257 0005	5	Right	141,8
A100 02 257 0007	A110 02 257 0007	7	Right	181,8
A100 02 257 0009	A110 02 257 0009	9	Right	221,8
A100 02 257 0011	A110 02 257 0011	11	Right	261,8
A100 02 257 0013	A110 02 257 0013	13	Right	301,8

Intended use : Temporary fixation of fractures, malunions, nonunions, osteotomies and pseudoarthroses of the proximal tibia. Those plates are used by lateral approach.

4,5 mm Distal Tibia Lateral Plate

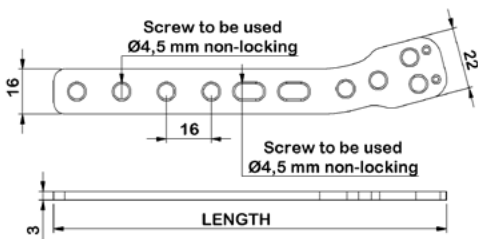

SS	TI	HOLES	SIDE	LENGTH (mm)
A100 02 240 0005	A110 02 240 0005	5	Left	108,3
A100 02 240 0007	A110 02 240 0007	7	Left	140,3
A100 02 240 0009	A110 02 240 0009	9	Left	172,3
A100 02 240 0011	A110 02 240 0011	11	Left	204,3
A100 02 240 0013	A110 02 240 0013	13	Left	236,3
A100 02 241 0005	A110 02 241 0005	5	Right	108,3
A100 02 241 0007	A110 02 241 0007	7	Right	140,3
A100 02 241 0009	A110 02 241 0009	9	Right	172,3
A100 02 241 0011	A110 02 241 0011	11	Right	204,3
A100 02 241 0013	A110 02 241 0013	13	Right	236,3

Intended use : Temporary fixation of fractures, malunions, nonunions, osteotomies and pseudoarthroses of the distal tibia.

Large Fragment Non-Locking Plates

3,5 mm Distal Tibia Medial Plate 2

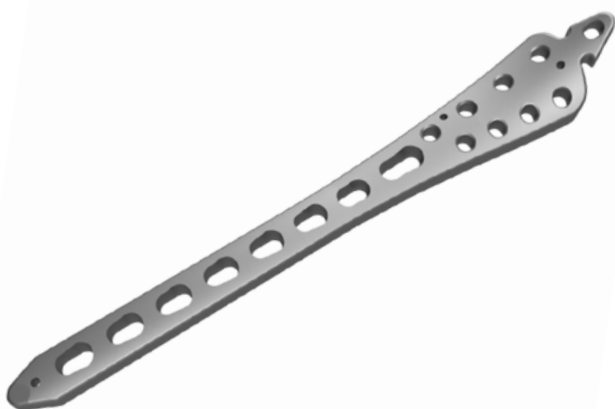

SS	TI	HOLES	SIDE	LENGTH (mm)
A100 02 242 0005	A110 02 242 0005	5	Left	125,9
A100 02 242 0007	A110 02 242 0007	7	Left	149,9
A100 02 242 0009	A110 02 242 0009	9	Left	173,9
A100 02 242 0011	A110 02 242 0011	11	Left	197,9
A100 02 242 0013	A110 02 242 0013	13	Left	221,9
A100 02 243 0005	A110 02 243 0005	5	Right	125,9
A100 02 243 0007	A110 02 243 0007	7	Right	149,9
A100 02 243 0009	A110 02 243 0009	9	Right	173,9
A100 02 243 0011	A110 02 243 0011	11	Right	197,9
A100 02 243 0013	A110 02 243 0013	13	Right	221,9

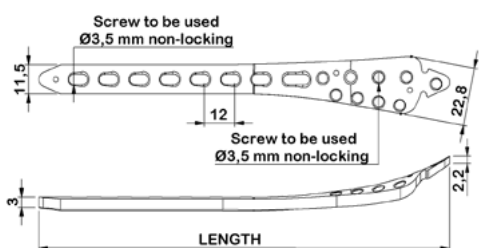

Intended use : Temporary fixation of fractures, malunions, nonunions, osteotomies and pseudoarthroses of the distal tibia. Those plates are used by medial approach.

3,5 mm Distal Fibula Plate 1



SS	TI	HOLES	SIDE	LENGTH (mm)
A5099102	A5098102	2	Left	61
A5099104	A5098104	4	Left	81
A5099105	A5098105	5	Left	91
A5099106	A5098106	6	Left	101
A5099107	A5098107	7	Left	111
A5099108	A5098108	8	Left	121
A5099109	A5098109	9	Left	131
A5099110	A5098110	10	Left	141
A5099202	A5098202	2	Right	61
A5099204	A5098204	4	Right	81
A5099205	A5098205	5	Right	91
A5099206	A5098206	6	Right	101
A5099207	A5098207	7	Right	111
A5099208	A5098208	8	Right	121
A5099209	A5098209	9	Right	131
A5099210	A5098210	10	Right	141

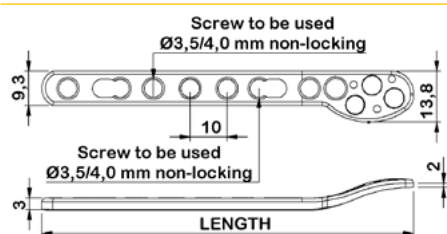

Intended use : Temporary fixation of fractures, malunions, nonunions, osteotomies and pseudoarthroses of the distal fibula.

"We supply WORLD's
Trauma Implants..."

Dhs/Dcs Locking/Non-Locking Plates



DHS-DCS Plates & Lag-Compression Screws

DHS Locking Plate 135°



SS	TI	HOLES	LENGTH (mm)
A5839102	A5838102	2	91,3
A5839103	A5838103	3	107,3
A5839104	A5838104	4	123,3
A5839105	A5838105	5	139,3
A5839106	A5838106	6	153,3
A5839107	A5838107	7	171,3
A5839108	A5838108	8	187,3
A5839109	A5838109	9	203,3
A5839110	A5838110	10	219,3
A5839111	A5838111	11	235,3
A5839112	A5838112	12	251,3

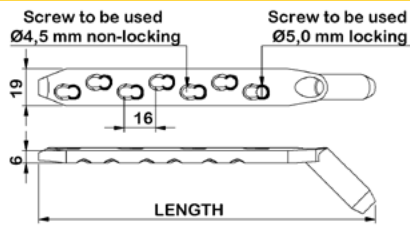

Intended use : Temporary fixation of fractures, malunions, nonunions, osteotomies and pseudoarthroses of the proximal femur (intertrochanteric fractures, subtrochanteric fractures, basilar neck fractures).

DCS Locking Plate 95°

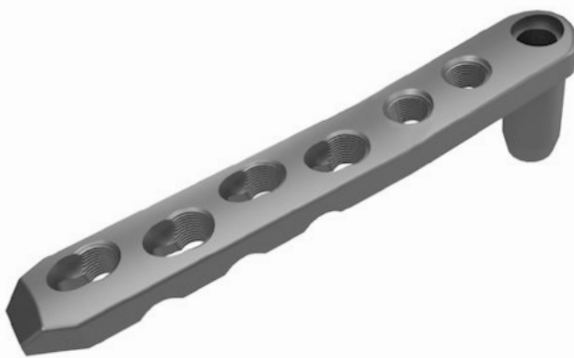

SS	TI	HOLES	LENGTH (mm)
A5829102	A5828102	2	86,8
A5829103	A5828103	3	102,8
A5829104	A5828104	4	118,8
A5829105	A5828105	5	134,8
A5829106	A5828106	6	150,8
A5829107	A5828107	7	166,8
A5829108	A5828108	8	182,8
A5829109	A5828109	9	198,8
A5829110	A5828110	10	214,8
A5829111	A5828111	11	230,8
A5829112	A5828112	12	246,8

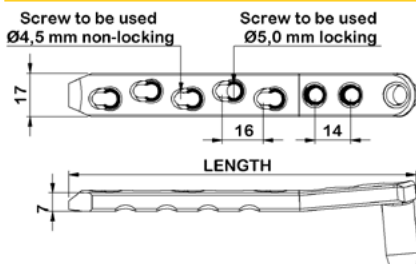

Intended use : Temporary fixation of fractures, malunions, nonunions, osteotomies and pseudoarthroses of the distal femur (Supracondylar, intercondylar fractures).

DHS-DCS Plates & Lag-Compression Screws

DHS Plate 135°



SS	TI	HOLES	LENGTH (mm)
A100 02 310 0002	A110 02 310 0002	2	91,4
A100 02 310 0003	A110 02 310 0003	3	107,4
A100 02 310 0004	A110 02 310 0004	4	123,4
A100 02 310 0005	A110 02 310 0005	5	139,4
A100 02 310 0006	A110 02 310 0006	6	155,4
A100 02 310 0007	A110 02 310 0007	7	171,4
A100 02 310 0008	A110 02 310 0008	8	187,4
A100 02 310 0009	A110 02 310 0009	9	203,4
A100 02 310 0010	A110 02 310 0010	10	219,4
A100 02 310 0011	A110 02 310 0011	11	235,4
A100 02 310 0012	A110 02 310 0012	12	251,4

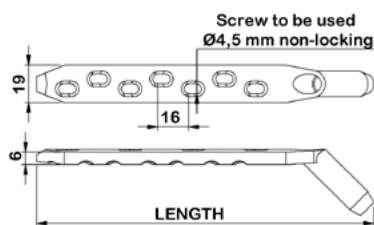

Intended use : Temporary fixation of fractures, malunions, nonunions, osteotomies and pseudoarthroses of the proximal femur (intertrochanteric fractures, subtrochanteric fractures, basilar neck fractures).

DCS Plate 95°

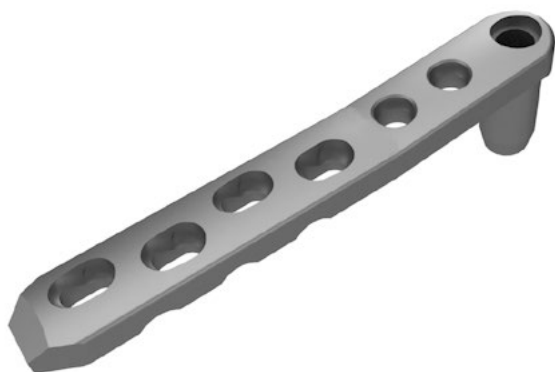

SS	TI	HOLES	LENGTH (mm)
A100 02 314 0002	A110 02 314 0002	2	86,7
A100 02 314 0003	A110 02 314 0003	3	102,7
A100 02 314 0004	A110 02 314 0004	4	118,7
A100 02 314 0005	A110 02 314 0005	5	134,7
A100 02 314 0006	A110 02 314 0006	6	150,7
A100 02 314 0007	A110 02 314 0007	7	166,7
A100 02 314 0008	A110 02 314 0008	8	182,7
A100 02 314 0009	A110 02 314 0009	9	198,7
A100 02 314 0010	A110 02 314 0010	10	214,7
A100 02 314 0011	A110 02 314 0011	11	230,7
A100 02 314 0012	A110 02 314 0012	12	246,7

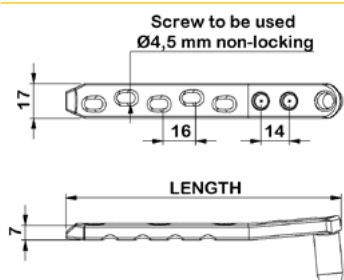

Intended use : Temporary fixation of fractures, malunions, nonunions, osteotomies and pseudoarthroses of the distal femur (Supracondylar, intercondylar fractures).

DHS-DCS Plates & Lag-Compression Screws

DHS/DCS Lag Screw



SS	TI	LENGTH (mm)
A100 03 011 0500	A110 03 011 0500	50
A100 03 011 0550	A110 03 011 0550	55
A100 03 011 0600	A110 03 011 0600	60
A100 03 011 0650	A110 03 011 0650	65
A100 03 011 0700	A110 03 011 0700	70
A100 03 011 0750	A110 03 011 0750	75
A100 03 011 0800	A110 03 011 0800	80
A100 03 011 0850	A110 03 011 0850	85
A100 03 011 0900	A110 03 011 0900	90
A100 03 011 0950	A110 03 011 0950	95 mm
A100 03 011 1000	A110 03 011 1000	100 mm
A100 03 011 1050	A110 03 011 1050	105 mm
A100 03 011 1100	A110 03 011 1100	110 mm
A100 03 011 1150	A110 03 011 1150	115 mm
A100 03 011 1200	A110 03 011 1200	120 mm
A100 03 011 1250	A110 03 011 1250	125 mm

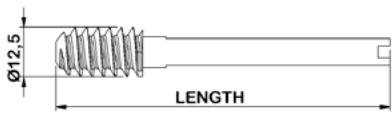

Intended use : Temporary fixation and compression at fracture site.
Used together with compression screw, DHS/DCS plates.

DHS/DCS Compression Screw



SS	TI	LENGTH (mm)
A100 03 011 1051	A5878050	28

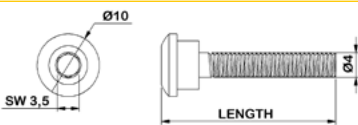

Intended use : Compression at fracture site.
Used together with lag screw, DHS/DCS plates.

"We supply WORLD's
Orthopedic & Trauma
Implants..."

Large Fragment Screws

Locking/Non-Locking



Large Fragment Locking Screws

5,0 mm Self-Tapping Locking Screw

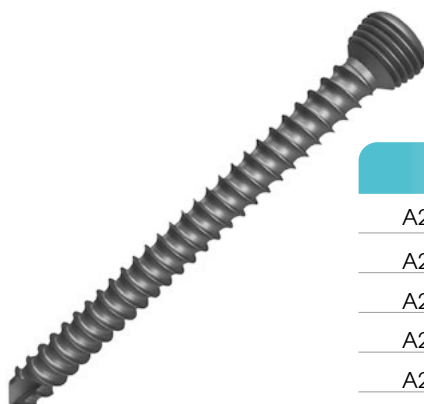

SS	TI	DIA. x LENGTH (mm)
A2095014	A2085014	5,0X14
A2095016	A2085016	5,0X16
A2095018	A2085018	5,0X18
A2095020	A2085020	5,0X20
A2095022	A2085022	5,0X22
A2095024	A2085024	5,0X24
A2095026	A2085026	5,0X26
A2095028	A2085028	5,0X28

SS	TI	DIA. x LENGTH (mm)
A2095030	A2085030	5,0X30
A2095032	A2085032	5,0X32
A2095034	A2085034	5,0X34
A2095036	A2085036	5,0X36
A2095038	A2085038	5,0X38
A2095040	A2085040	5,0X40
A2095042	A2085042	5,0X42
A2095044	A2085044	5,0X44
A2095046	A2085046	5,0X46
A2095048	A2085048	5,0X48
A2095050	A2085050	5,0X50
A2095055	A2085055	5,0X55
A2095060	A2085060	5,0X60
A2095065	A2085065	5,0X65
A2095070	A2085070	5,0X70
A2095075	A2085075	5,0X75
A2095080	A2085080	5,0X80
A2095085	A2085085	5,0X85
A2095090	A2085090	5,0X90

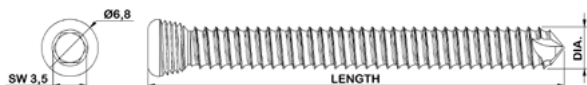

5,0 mm Locking Cancellous Screw Full Threaded



SS	TI	DIA. x LENGTH (mm)
A33802035	A33702035	5,0X35
A33802040	A33702040	5,0X40
A33802045	A33702045	5,0X45
A33802050	A33702050	5,0X50
A33802055	A33702055	5,0X55
A33802060	A33702060	5,0X60
A33802065	A33702065	5,0X65
A33802070	A33702070	5,0X70
A33802075	A33702075	5,0X75
A33802080	A33702080	5,0X80
A33802085	A33702085	5,0X85
A33802090	A33702090	5,0X90
A33802095	A33702095	5,0X95
A33802100	A33702100	5,0X100
A33802105	A33702105	5,0X105
A33802110	A33702110	5,0X110

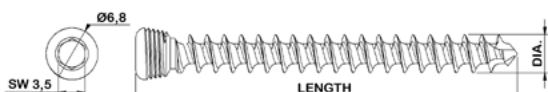

Large Fragment Locking Screws

5,0 mm Locking Cancellous Screw Partially Threaded



SS	TI	DIA. x LENGTH (mm)
A33801035	A33701035	5,0X35
A33801040	A33701040	5,0X40
A33801045	A33701045	5,0X45
A33801050	A33701050	5,0X50
A33801055	A33701055	5,0X55
A33801060	A33701060	5,0X60
A33801065	A33701065	5,0X65
A33801070	A33701070	5,0X70
A33801075	A33701075	5,0X75
A33801080	A33701080	5,0X80
A33801085	A33701085	5,0X85
A33801090	A33701090	5,0X90
A33801095	A33701095	5,0X95
A33801100	A33701100	5,0X100
A33801105	A33701105	5,0X105
A33801110	A33701110	5,0X110

5,0 mm Self-Drilling Locking Screw

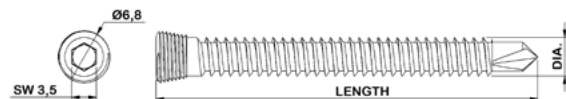
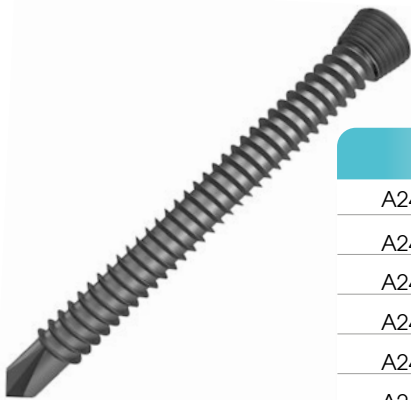

SS	TI	DIA. x LENGTH (mm)
A2495018	A2485018	5,0X18
A2495020	A2485020	5,0X20
A2495022	A2485022	5,0X22
A2495024	A2485024	5,0X24
A2495026	A2485026	5,0X26
A2495028	A2485028	5,0X28
A2495030	A2485030	5,0X30

SS	TI	DIA. x LENGTH (mm)
A2495032	A2485032	5,0X32
A2495034	A2485034	5,0X34
A2495036	A2485036	5,0X36
A2495038	A2485038	5,0X38
A2495040	A2485040	5,0X40
A2495042	A2485042	5,0X42
A2495044	A2485044	5,0X44
A2495046	A2485046	5,0X46
A2495048	A2485048	5,0X48
A2495050	A2485050	5,0X50
A2495055	A2485055	5,0X55
A2495060	A2485060	5,0X60
A2495065	A2485065	5,0X65
A2495070	A2485070	5,0X70
A2495075	A2485075	5,0X75
A2495080	A2485080	5,0X80
A2495085	A2485085	5,0X85
A2495090	A2485090	5,0X90

Large Fragment Locking Screws

5,0 mm Cable Locking Screw



TI
A900 03 020 0008

Locking Screw Plug



TI
A900 03 020 0009

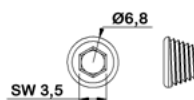
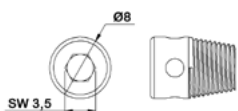

6,5 mm Locking Cancellous Screw Full Threaded



SS	TI	DIA. x LENGTH (mm)
A34865035	A34765035	6,5X35
A34865040	A34765040	6,5X40
A34865045	A34765045	6,5X45
A34865050	A34765050	6,5X50
A34865055	A34765055	6,5X55
A34865060	A34765060	6,5X60
A34865065	A34765065	6,5X65
A34865070	A34765070	6,5X70
A34865075	A34765075	6,5X75
A34865080	A34765080	6,5X80
A34865085	A34765085	6,5X85
A34865090	A34765090	6,5X90
A34865095	A34765095	6,5X95
A34865100	A34765100	6,5X100
A34865105	A34765105	6,5X105
A34865110	A34765110	6,5X110

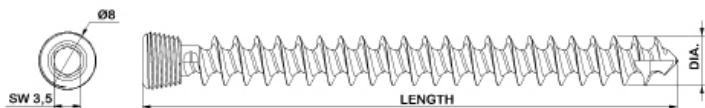

Large Fragment Locking Screws

6,5 mm Locking Cancellous Screw 16 mm Threaded

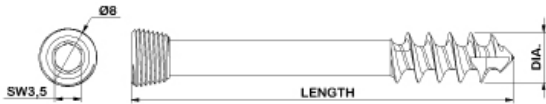

SS	TI	DIA. x LENGTH (mm)
A34867035	A34767035	6,5X35
A34867040	A34767040	6,5X40
A34867045	A34767045	6,5X45
A34867050	A34767050	6,5X50
A34867055	A34767055	6,5X55
A34867060	A34767060	6,5X60
A34867065	A34767065	6,5X65
A34867070	A34767070	6,5X70
A34867075	A34767075	6,5X75
A34867080	A34767080	6,5X80
A34867085	A34767085	6,5X85
A34867090	A34767090	6,5X90
A34867095	A34767095	6,5X95
A34867100	A34767100	6,5X100
A34867105	A34767105	6,5X105
A34867110	A34767110	6,5X110

6,5 mm Locking Cancellous Screw 32 mm Threaded

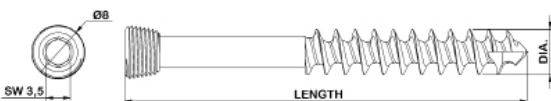

SS	TI	DIA. x LENGTH (mm)
A34866045	A34766045	6,5X45
A34866050	A34766050	6,5X50
A34866055	A34766055	6,5X55
A34866060	A34766060	6,5X60
A34866065	A34766065	6,5X65
A34866070	A34766070	6,5X70
A34866075	A34766075	6,5X75
A34866080	A34766080	6,5X80
A34866085	A34766085	6,5X85
A34866090	A34766090	6,5X90
A34866095	A34766095	6,5X95
A34866100	A34766100	6,5X100
A34866105	A34766105	6,5X105
A34866110	A34766110	6,5X110

Large Fragment Locking Screws

5,0 mm Self-Tapping Locking Cannulated Screw



SS	TI	DIA. x LENGTH (mm)	SS	TI	DIA. x LENGTH (mm)
A2045014	A2055014	5,0X14	A2045032	A2055032	5,0X32
A2045016	A2055016	5,0X16	A2045034	A2055034	5,0X34
A2045018	A2055018	5,0X18	A2045036	A2055036	5,0X36
A2045020	A2055020	5,0X20	A2045038	A2055038	5,0X38
A2045022	A2055022	5,0X22	A2045040	A2055040	5,0X40
A2045024	A2055024	5,0X24	A2045042	A2055042	5,0X42
A2045026	A2055026	5,0X26	A2045044	A2055044	5,0X44
A2045028	A2055028	5,0X28	A2045046	A2055046	5,0X46
A2045030	A2055030	5,0X30	A2045048	A2055048	5,0X48
			A2045050	A2055050	5,0X50
			A2045055	A2055055	5,0X55
			A2045060	A2055060	5,0X60
			A2045065	A2055065	5,0X65
			A2045070	A2055070	5,0X70
			A2045075	A2055075	5,0X75
			A2045080	A2055080	5,0X80
			A2045085	A2055085	5,0X85
			A2045090	A2055090	5,0X90

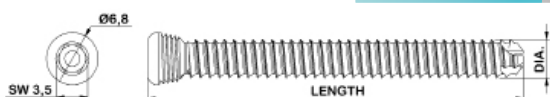

4,5 mm Self-Tapping Cortical Screw



SS	TI	DIA. x LENGTH (mm)	SS	TI	DIA. x LENGTH (mm)
A100 03 223 0140	A110 03 223 0140	4,5X14	A100 03 223 0400	A110 03 223 0400	4,5X40
A100 03 223 0160	A110 03 223 0160	4,5X16	A100 03 223 0420	A110 03 223 0420	4,5X42
A100 03 223 0180	A110 03 223 0180	4,5X18	A100 03 223 0440	A110 03 223 0440	4,5X44
A100 03 223 0200	A110 03 223 0200	4,5X20	A100 03 223 0460	A110 03 223 0460	4,5X46
A100 03 223 0220	A110 03 223 0220	4,5X22	A100 03 223 0480	A110 03 223 0480	4,5X48
A100 03 223 0240	A110 03 223 0240	4,5X24	A100 03 223 0500	A110 03 223 0500	4,5X50
A100 03 223 0260	A110 03 223 0260	4,5X26	A100 03 223 0520	A110 03 223 0520	4,5X52
A100 03 223 0280	A110 03 223 0280	4,5X28	A100 03 223 0540	A110 03 223 0540	4,5X54
A100 03 223 0300	A110 03 223 0300	4,5X30	A100 03 223 0560	A110 03 223 0560	4,5X56
A100 03 223 0320	A110 03 223 0320	4,5X32	A100 03 223 0580	A110 03 223 0580	4,5X58
A100 03 223 0340	A110 03 223 0340	4,5X34	A100 03 223 0600	A110 03 223 0600	4,5X60
A100 03 223 0360	A110 03 223 0360	4,5X36	A100 03 223 0650	A110 03 223 0650	4,5X65
A100 03 223 0380	A110 03 223 0380	4,5X38	A100 03 223 0700	A110 03 223 0700	4,5X70

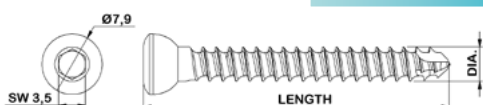

Large Fragment Non-Locking Screws

6,5 mm Cancellous Screw 16 mm Threaded



SS	TI	DIA. x LENGTH (mm)
A100 03 225 0500	A110 03 225 0500	6,5X50
A100 03 225 0550	A110 03 225 0550	6,5X55
A100 03 225 0600	A110 03 225 0600	6,5X60
A100 03 225 0650	A110 03 225 0650	6,5X65
A100 03 225 0700	A110 03 225 0700	6,5X70
A100 03 225 0750	A110 03 225 0750	6,5X75
A100 03 225 0800	A110 03 225 0800	6,5X80
A100 03 225 0850	A110 03 225 0850	6,5X85
A100 03 225 0900	A110 03 225 0900	6,5X90
A100 03 225 0950	A110 03 225 0950	6,5X95
A100 03 225 1000	A110 03 225 1000	6,5X100
A100 03 225 1050	A110 03 225 1050	6,5X105
A100 03 225 1100	A110 03 225 1100	6,5X110



6,5 mm Cancellous Screw 32 mm Threaded



SS	TI	DIA. x LENGTH (mm)
A100 03 226 0500	A110 03 226 0500	6,5X50
A100 03 226 0550	A110 03 226 0550	6,5X55
A100 03 226 0600	A110 03 226 0600	6,5X60
A100 03 226 0650	A110 03 226 0650	6,5X65
A100 03 226 0700	A110 03 226 0700	6,5X70
A100 03 226 0750	A110 03 226 0750	6,5X75
A100 03 226 0800	A110 03 226 0800	6,5X80
A100 03 226 0850	A110 03 226 0850	6,5X85
A100 03 226 0900	A110 03 226 0900	6,5X90
A100 03 226 0950	A110 03 226 0950	6,5X95
A100 03 226 1000	A110 03 226 1000	6,5X100
A100 03 226 1050	A110 03 226 1050	6,5X105
A100 03 226 1100	A110 03 226 1100	6,5X110



Large Fragment Non-Locking Screws

6,5 mm Cancellous Screw Full Threaded

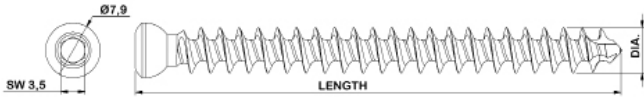

SS	Ti	DIA. x LENGTH (mm)
A100 03 227 0500	A110 03 227 0500	6,5X50
A100 03 227 0550	A110 03 227 0550	6,5X55
A100 03 227 0600	A110 03 227 0600	6,5X60
A100 03 227 0650	A110 03 227 0650	6,5X65
A100 03 227 0700	A110 03 227 0700	6,5X70
A100 03 227 0750	A110 03 227 0750	6,5X75
A100 03 227 0800	A110 03 227 0800	6,5X80
A100 03 227 0850	A110 03 227 0850	6,5X85
A100 03 227 0900	A110 03 227 0900	6,5X90
A100 03 227 0950	A110 03 227 0950	6,5X95
A100 03 227 1000	A110 03 227 1000	6,5X100
A100 03 227 1050	A110 03 227 1050	6,5X105
A100 03 227 1100	A110 03 227 1100	6,5X110

4,5 mm Malleolar Screw



SS	Ti	DIA. x LENGTH (mm)
A100 03 224 0250	A110 03 224 0250	4,5X25
A100 03 224 0300	A110 03 224 0300	4,5X30
A100 03 224 0350	A110 03 224 0350	4,5X35
A100 03 224 0400	A110 03 224 0400	4,5X40
A100 03 224 0450	A110 03 224 0450	4,5X45
A100 03 224 0500	A110 03 224 0500	4,5X50
A100 03 224 0550	A110 03 224 0550	4,5X55
A100 03 224 0600	A110 03 224 0600	4,5X60
A100 03 224 0650	A110 03 224 0650	4,5X65
A100 03 224 0700	A110 03 224 0700	4,5X70

Large Fragment Non-Locking Screws

Washer Ø13

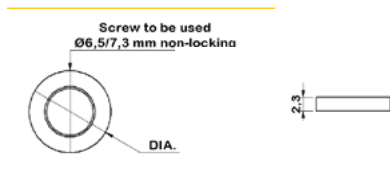

TI	DIA. (mm)
A110 04 000 0014	13

Washer Ø10

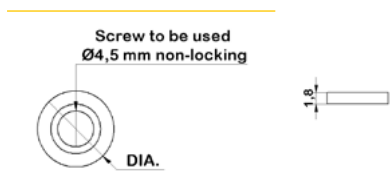

SS	DIA. (mm)
A110 04 000 0010	10

Washer Ø8,0

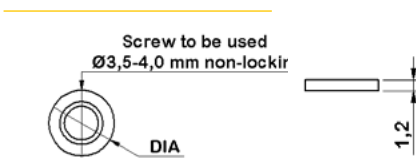

SS	TI	DIA. (mm)
A34004108	A34004008	8

■ ■ ■ ■ ■
f aysam.orthopedics

t aysamortho

in aysam

YouTube aysam orthopaedics



"We supply WORLD's
Orthopedic & Trauma
Implants..."

Mini Fragment Locking Plates & Screws



Mini Fragment Locking Plates & Screws

1,5 mm Mini Straight Compression Locking Plate

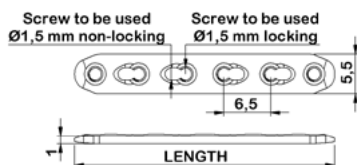

TI	HOLES	LENGTH (mm)
A310 02 053 2704	4	23
A310 02 053 2706	6	36

Intended use : Temporary fixation of fractures, osteotomies, nonunions, malunions, pseudoarthroses, replantations, and fusions of small bones, maxillo-facial bones and small bone fragments.

1,5 mm Mini Straight Reconstruction Locking Plate

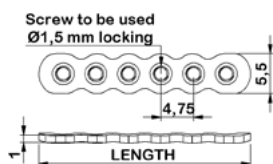

TI	HOLES	LENGTH (mm)
A310 02 053 2705	6	29
A310 02 053 2712	12	59

Intended use : Temporary fixation of fractures, osteotomies, nonunions, malunions, pseudoarthroses, replantations, and fusions of small bones, maxillo-facial bones and small bone fragments.

1,5 mm Mini T Locking Plate

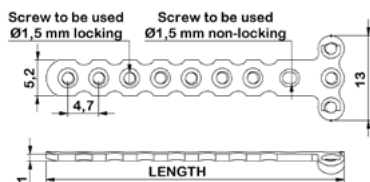

TI	HOLES (SHAFT)	HOLES (HEAD)	LENGTH (mm)
A310 02 053 2709	8	3	44,5
A310 02 053 2710	8	4	44,5

Intended use : Fixation of fractures, osteotomies, nonunions, replantations, and fusions of small bones and small bone fragments.

1,5 mm Mini Strut Locking Plate

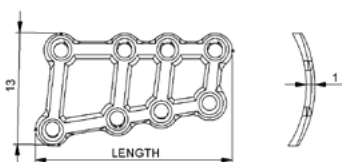

TI	SIDE	LENGTH (mm)
A310 02 053 2707	RIGHT	23
A310 02 053 2708	LEFT	23

Intended use : Temporary fixation of fractures, osteotomies, nonunions, malunions, pseudoarthroses, replantations, and fusions of small bones, maxillo-facial bones and small bone fragments.

1,5 mm Mini Y Locking Plate (3 holes head)

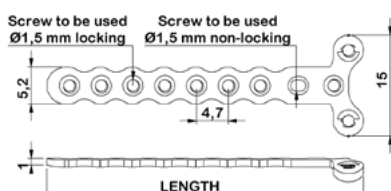

TI	HOLES (SHAFT)	HOLES (HEAD)	LENGTH (mm)
A310 02 053 2711	8	3	47

Intended use : Temporary fixation of fractures, osteotomies, nonunions, malunions, pseudoarthroses, replantations, and fusions of small bones, maxillo-facial bones and small bone fragments.

Mini Fragment Locking Plates & Screws

1,5 mm Mini Condylar Locking Plate

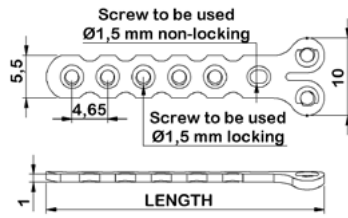

TI	HOLES (SHAFT)	HOLES (HEAD)	LENGTH (mm)
A310 02 053 0206	6	2	36

Intended use: Temporary fixation of fractures, osteotomies, nonunions, malunions, pseudoarthroses, replantations, and fusions of small bones, maxillo-facial bones and small bone fragments.

1,5 mm Mini Locking Screw

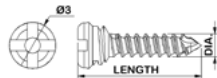

TI	DIA. x LENGTH (mm)	TI	DIA. x LENGTH (mm)
A1982606	1,5X6	A1982632	1,5X13
A1982626	1,5X7	A1982614	1,5X14
A1982608	1,5X8	A1982634	1,5X15
A1982628	1,5X9	A1982616	1,5X16
A1982610	1,5X10	A1982618	1,5X18
A1982630	1,5X11	A1982620	1,5X20
A1982612	1,5X12	A1982622	1,5X22
		A1982624	1,5X24

1,5 mm Mini Screw



TI	DIA. x LENGTH (mm)
A110 03 215 0060	1,5X6
A110 03 215 0070	1,5X7
A110 03 215 0080	1,5X8
A110 03 215 0090	1,5X9
A110 03 215 0100	1,5X10
A110 03 215 0120	1,5X12
A110 03 215 0140	1,5X14
A110 03 215 0160	1,5X16
A110 03 215 0180	1,5X18
A110 03 215 0200	1,5X20

Mini Fragment Locking Plates & Screws

2,0 mm Mini Straight Locking Plate

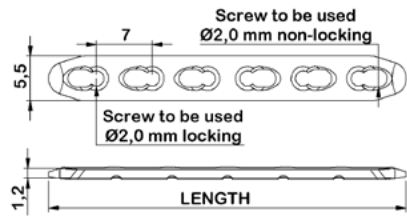

TI	HOLES	LENGTH (mm)
A110 02 182 0004	4	31
A110 02 182 0005	5	38
A110 02 182 0006	6	45
A110 02 182 0007	7	52
A110 02 182 0008	8	59
A110 02 182 0010	10	73

Intended use : Temporary fixation of fractures, osteotomies, nonunions, malunions, pseudoarthroses, replantations, and fusions of small bones, maxillo-facial bones and small bone fragments.

2,0 mm Mini Condylar Locking Plate (2 holes head)

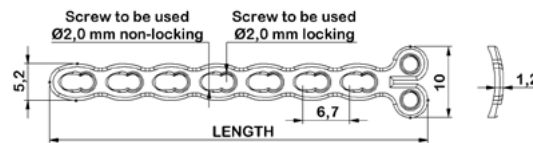

TI	HOLES (SHAFT)	HOLES (HEAD)	LENGTH (mm)
A310 02 042 0003	7	2	54

Intended use : Temporary fixation of fractures, osteotomies, nonunions, malunions, pseudoarthroses, replantations, and fusions of small bones, maxillo-facial bones and small bone fragments.

2,0 mm Mini Rotation Correction Locking Plate (2 holes head)

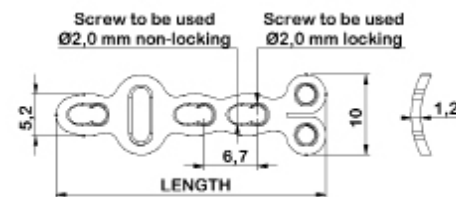

TI	HOLES (SHAFT)	HOLES (HEAD)	LENGTH (mm)
A310 02 051 0012	4	2	34
A310 02 051 0013	5	2	40

Intended use : Temporary fixation of fractures, osteotomies, nonunions, malunions, pseudoarthroses, replantations, and fusions of small bones, maxillo-facial bones and small bone fragments.

Mini Fragment Locking Plates & Screws

2,0 mm Mini T Locking Plate (3 holes head)

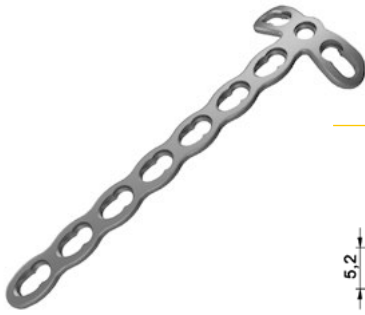

TI	HOLES (SHAFT)	HOLES (HEAD)	LENGTH (mm)
A310 02 042 0012	7	3	52,5

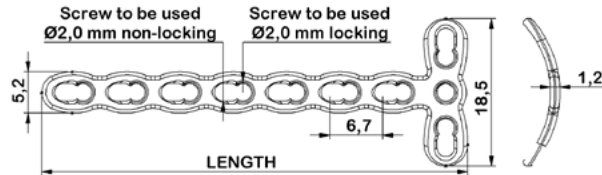

Intended use : Temporary fixation of fractures, osteotomies, nonunions, malunions, pseudoarthroses, replantations, and fusions of small bones, maxillo-facial bones and small bone fragments.

2,0 mm Mini Adaptation Locking Plate

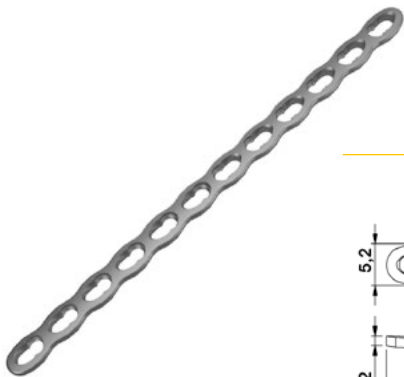

TI	HOLES	LENGTH (mm)
A310 02 063 0003	12	81,26

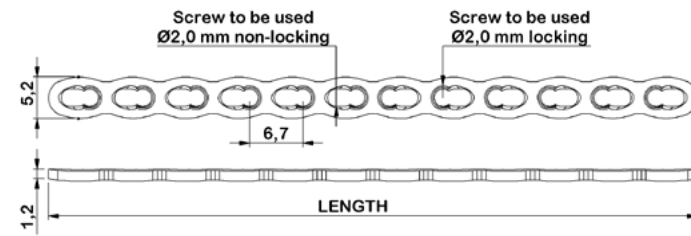

Intended use : Temporary fixation of fractures, osteotomies, nonunions, malunions, pseudoarthroses, replantations, and fusions of small bones, maxillo-facial bones and small bone fragments.

2,0 mm Mini Adaptation T Locking Plate (2 holes head)



TI	HOLES (SHAFT)	HOLES (HEAD)	LENGTH (mm)
A310 02 041 0103	7	2	52,5

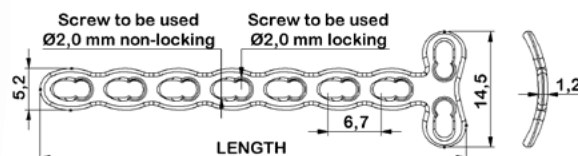

Intended use : Temporary fixation of fractures, osteotomies, nonunions, malunions, pseudoarthroses, replantations, and fusions of small bones, maxillo-facial bones and small bone fragments.

Mini Fragment Locking Plates & Screws

2,0 mm Mini Adaptation Y Locking Plate (3 holes head)

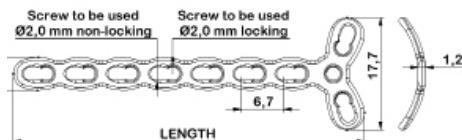

TI	HOLES (SHAFT)	HOLES (HEAD)	LENGTH (mm)
A110 02 182 0009	7	3	54

Intended use : Temporary fixation of fractures, osteotomies, nonunions, malunions, pseudoarthroses, replantations, and fusions of small bones, maxillo-facial bones and small bone fragments.

2,0 mm Mini H Locking Plate

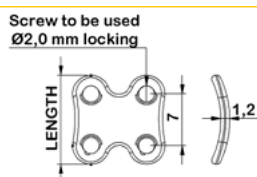

TI	HOLES	LENGTH (mm)
A110 02 182 0003	4	12

Intended use : Temporary fixation of fractures, osteotomies, nonunions, malunions, pseudoarthroses, replantations, and fusions of small bones, maxillo-facial bones and small bone fragments.

2,0 mm Mini Locking Screw

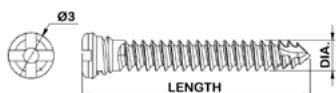

TI	DIA. x LENGTH (mm)	TI	DIA. x LENGTH (mm)
A1982005	2,0X6	A1982015	2,0X15
A1982007	2,0X7	A1982025	2,0X16
A1982017	2,0X8	A1982027	2,0X18
A1982009	2,0X9	A1982636	2,0X20
A1982019	2,0X10	A1982638	2,0X22
A1982011	2,0X11	A1982640	2,0X24
A1982021	2,0X12	A1983565	2,0X26
A1982013	2,0X13	A1983570	2,0X28
A1982023	2,0X14		

2,0 mm Mini Screw

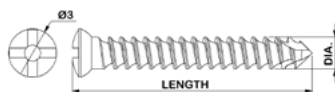

TI	DIA. x LENGTH (mm)	TI	DIA. x LENGTH (mm)
A110 03 216 0060	2,0X6	A110 03 216 0160	2,0X16
A110 03 216 0320	2,0X7	A110 03 216 0180	2,0X18
A110 03 216 0080	2,0X8	A110 03 216 0200	2,0X20
A110 03 216 0340	2,0X9	A110 03 216 0220	2,0X22
A110 03 216 0100	2,0X10	A110 03 216 0240	2,0X24
A110 03 216 0360	2,0X11	A110 03 216 0260	2,0X26
A110 03 216 0120	2,0X12	A110 03 216 0280	2,0X28
A110 03 216 0380	2,0X13	A110 03 216 0300	2,0X30
A110 03 216 0140	2,0X14		

Mini Fragment Locking Plates & Screws

2,4 mm Mini Straight Locking Plate

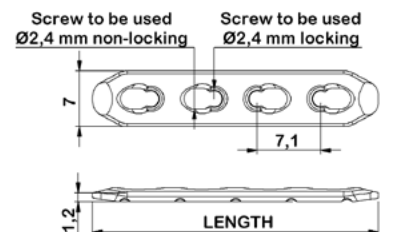

TI	HOLES	LENGTH (mm)
A110 02 222 0006	4	36,0
A110 02 222 0008	5	43,6
A110 02 222 0010	6	51,2
A110 02 222 0012	7	58,8
A110 02 222 0014	8	66,4
A110 02 222 0016	10	81,6

Intended use : Temporary fixation of fractures, osteotomies, nonunions, replantations, and fusions of small bones and small bone fragments.

2,4 mm Mini T Locking Plate (3 holes head)

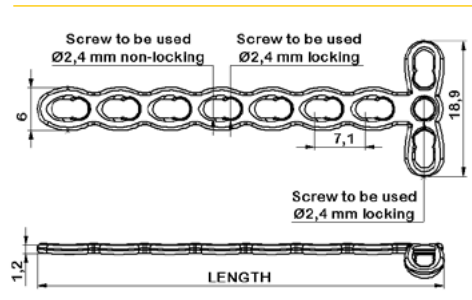

TI	HOLES (SHAFT)	HOLES (HEAD)	LENGTH (mm)
A110 02 222 0018	7	3	57

Intended use : Temporary fixation of fractures, osteotomies, nonunions, replantations, and fusions of small bones and small bone fragments.

2,4 mm Mini Condylar Locking Plate

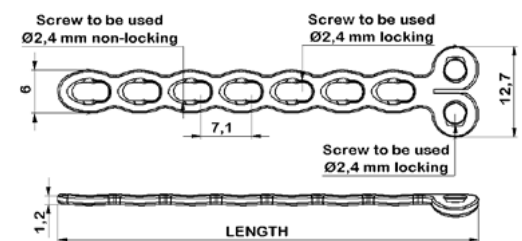

TI	HOLES (SHAFT)	HOLES (HEAD)	LENGTH (mm)
A110 02 222 0020	7	2	59

Intended use : Fixation of fractures, osteotomies, nonunions, replantations, and fusions of small bones and small bone fragments.

Mini Fragment Locking Plates & Screws

2,4 mm Mini Adaptation Locking Plate

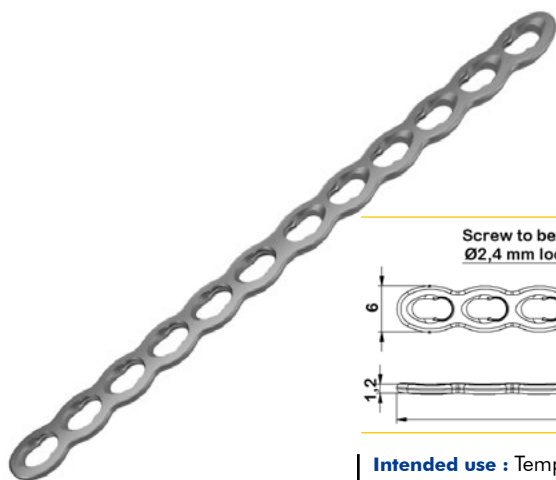

TI	HOLES	LENGTH (mm)
A110 02 222 0022	12	87,9

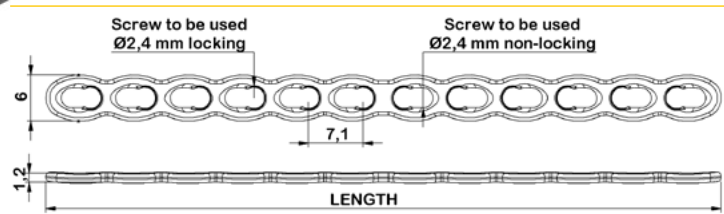

Intended use : Temporary fixation of fractures, osteotomies, nonunions, replantations, and fusions of small bones and small bone fragments.

2,4 mm Mini Adaptation T Locking Plate (2 holes head)



TI	HOLES (SHAFT)	HOLES (HEAD)	LENGTH (mm)
A110 02 222 0024	7	2	59

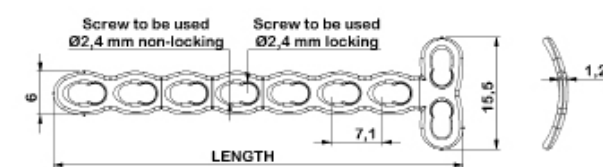

Intended use : Temporary fixation of fractures, osteotomies, nonunions, replantations, and fusions of small bones and small bone fragments.

2,4 mm Mini Adaptation Y Locking Plate (3 holes head)



TI	HOLES (SHAFT)	HOLES (HEAD)	LENGTH (mm)
A310 02 043 0013	7	3	60,5

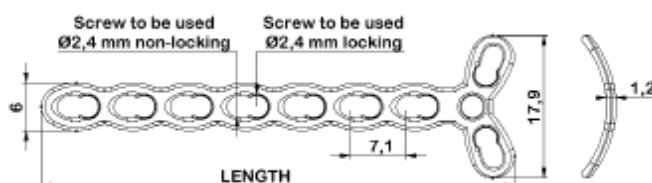

Intended use : Temporary fixation of fractures, osteotomies, nonunions, replantations, and fusions of small bones and small bone fragments.

Mini Fragment Locking Plates & Screws

2,4 mm Mini Locking Screw

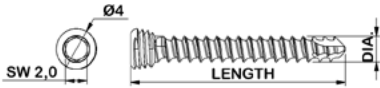

TI	DIA. x LENGTH (mm)
A110 03 213 0060	2,4X6
A100 03216 0070	2,4X7
A110 03 213 0080	2,4X8
A100 03216 0090	2,4X9
A110 03 213 0100	2,4X10
A100 03216 0011	2,4X11
A110 03 213 0120	2,4X12
A100 03216 0013	2,4X13
A110 03 213 0140	2,4X14

TI	DIA. x LENGTH (mm)
A100 03216 0015	2,4X15
A110 03 213 0160	2,4X16
A110 03 213 0180	2,4X18
A110 03 213 0200	2,4X20
A110 03 213 0220	2,4X22
A110 03 213 0240	2,4X24
A110 03 213 0260	2,4X26
A110 03 213 0280	2,4X28
A110 03 213 0300	2,4X30

2,4 mm Mini Screw

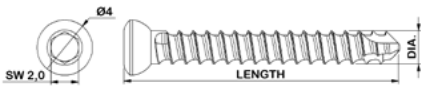

TI	DIA. x LENGTH (mm)
A1982306	2,4X6
A1982308	2,4X8
A1982310	2,4X10
A1982312	2,4X12
A1982314	2,4X14
A1982316	2,4X16
A1982318	2,4X18
A1982320	2,4X20
A1982322	2,4X22

TI	DIA. x LENGTH (mm)
A1982324	2,4X24
A1982326	2,4X26
A1982328	2,4X28
A1982330	2,4X30
A100 03216 0017	2,4X7
A100 03216 0019	2,4X9
A100 03216 0021	2,4X11
A100 03216 0023	2,4X13
A100 03216 0025	2,4X15

2,7 mm Mini Condylar Locking Plate

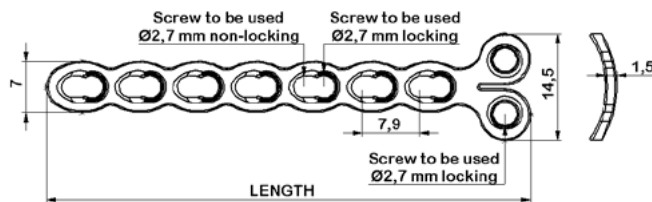
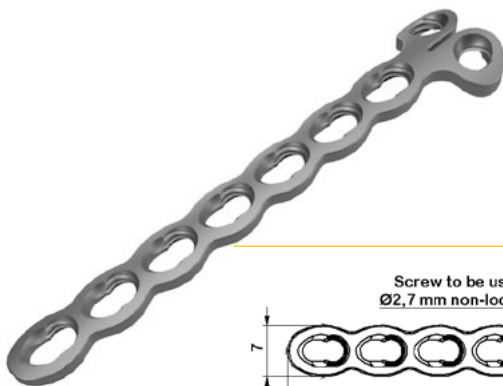

TI	HOLES (SHAFT)	HOLES (HEAD)	LENGTH (mm)
A310 02 063 0002	7	2	66

Intended use : Temporary fixation of fractures, osteotomies, nonunions, replantations, and fusions of small bones and small bone fragments.

Mini Fragment Locking Plates & Screws

2,7 mm Mini Adaptation Locking Plate

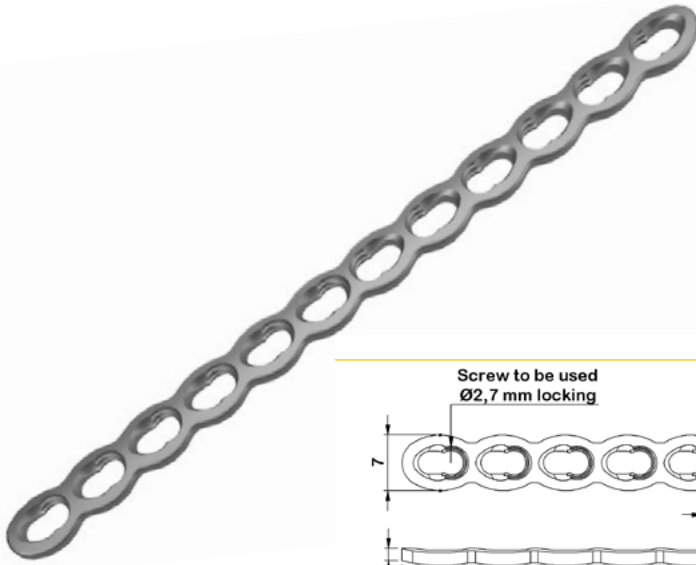

TI	HOLES	LENGTH (mm)
A110 02 410 0012	12	97

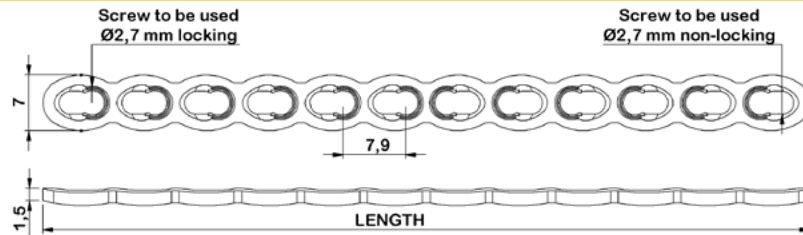

Intended use : Temporary fixation of fractures, osteotomies, nonunions, replantations, and fusions of small bones and small bone fragments.

2,7 mm Mini T Locking Plate (2 holes head)

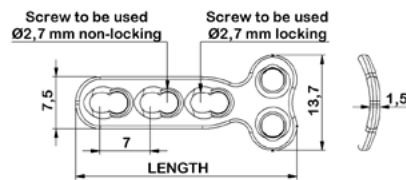

TI	HOLES (SHAFT)	HOLES (HEAD)	LENGTH (mm)
A310 02 062 0002	3	2	32
A310 02 062 0003	4	2	40

Intended use : Temporary fixation of fractures, osteotomies, nonunions, replantations, and fusions of small bones and small bone fragments.

2,7 mm Mini Straight Locking Plate

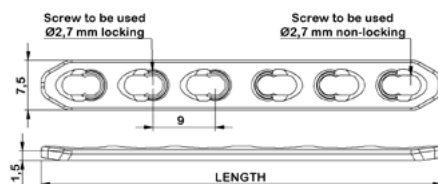
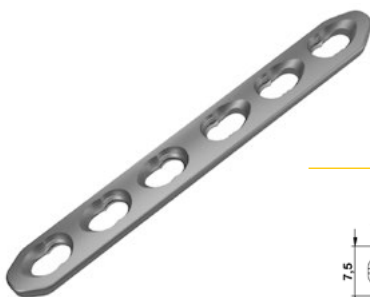

TI	HOLES	LENGTH (mm)
A110 02 410 0004	4	40
A110 02 410 0005	5	49
A110 02 410 0006	6	58
A110 02 410 0007	7	67
A110 02 410 0008	8	76
A110 02 410 0010	10	94

Intended use : Temporary fixation of fractures, osteotomies, nonunions, replantations, and fusions of small bones and small bone fragments.

Mini Fragment Locking Plates & Screws

2,7 mm Mini L Locking Plate

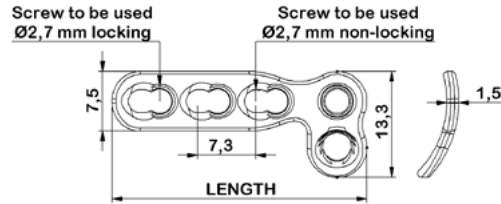

TI	HOLES (SHAFT)	HOLES (HEAD)	LENGTH (mm)	SIDE
A310 02 040 0003	3	2	32	Left
A310 02 041 0003	3	2	32	Right
A310 02 050 0003	4	2	40	Left
A310 02 050 0004	4	2	40	Right

Intended use : Temporary fixation of fractures, osteotomies, nonunions, replantations, and fusions of small bones and small bone fragments.

2,7 mm Mini Oblique L Locking Plate

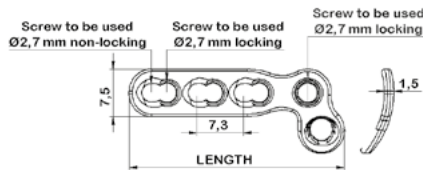

TI	HOLES (SHAFT)	HOLES (HEAD)	LENGTH (mm)	SIDE
A310 02 060 0003	3	2	35	Left
A310 02 061 0003	3	2	35	Right
A110 02 410 0002	4	2	42	Left
A110 02 410 0009	4	2	42	Right

Intended use : Temporary fixation of fractures, osteotomies, nonunions, replantations, and fusions of small bones and small bone fragments.

2,7 mm Mini Locking Screw

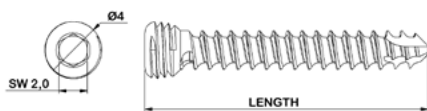

TI	DIA. x LENGTH (mm)	TI	DIA. x LENGTH (mm)
A1982710	2,7X10	A1982726	2,7X26
A1982712	2,7X12	A1982728	2,7X28
A1982714	2,7X14	A1982730	2,7X30
A1982716	2,7X16	A1982732	2,7X32
A1982718	2,7X18	A1982734	2,7X34
A1982720	2,7X20	A1982736	2,7X36
A1982722	2,7X22	A1982738	2,7X38
A1982724	2,7X24	A1982740	2,7X40

2,7 mm Mini Screw

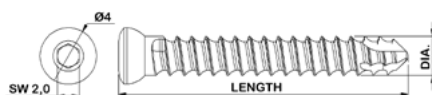

TI	DIA. x LENGTH (mm)	TI	DIA. x LENGTH (mm)
A110 03 217 0100	2,7X10	A110 03 217 0260	2,7X26
A110 03 217 0120	2,7X12	A110 03 217 0280	2,7X28
A110 03 217 0140	2,7X14	A110 03 217 0300	2,7X30
A110 03 217 0160	2,7X16	A110 03 217 0320	2,7X32
A110 03 217 0180	2,7X18	A110 03 217 0340	2,7X34
A110 03 217 0200	2,7X20	A110 03 217 0360	2,7X36
A110 03 217 0220	2,7X22	A110 03 217 0380	2,7X38
A110 03 217 0240	2,7X24	A110 03 217 0400	2,7X40



■ www.aysam.com.tr
■ www.aysamstore.com.tr
■ aysam@aysam.com.tr
f [aysam.orthopedics](https://www.facebook.com/aysam.orthopedics)
t [aysamortho](https://twitter.com/aysamortho)
in [aysam](https://www.linkedin.com/company/aysam)
You [aysam orthopaedics](https://www.youtube.com/channel/UC...)

"We supply WORLD's
Orthopedic & Trauma
Implants..."

Chest Wall Plates, Screws & Splints



Chest Wall Plates, Screws & Splints

2,9 mm Sternal Locking T Plate



TI	HOLES
A15408 128 07	7



TI	HOLES
A15408 128 08	8

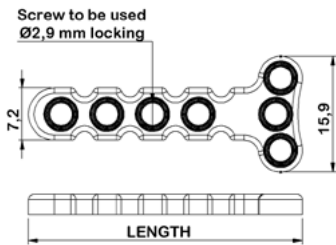

Intended use : Temporary fixation of fractures, malunions, nonunions, pseudoarthroses and osteotomies of the sternum.

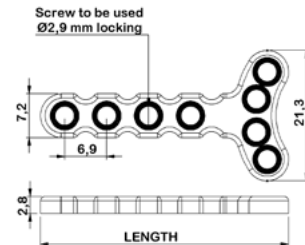

Intended use : Temporary fixation of fractures, malunions, nonunions, pseudoarthroses and osteotomies of the sternum.

2,9 mm Sternal Locking I Plate



TI	HOLES
A15408 2906	9



TI	HOLES
A15408 2908	11

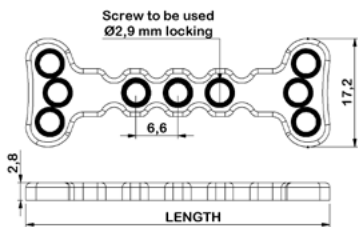

Intended use : Temporary fixation of fractures, malunions, nonunions, pseudoarthroses and osteotomies of the sternum.

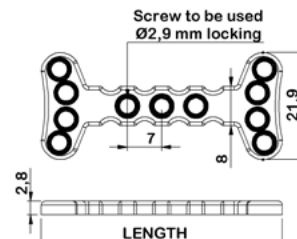

Intended use : Temporary fixation of fractures, malunions, nonunions, pseudoarthroses and osteotomies of the sternum.

Chest Wall Plates, Screws & Splints

2,9 mm Sternal Locking Straight Plate



TI	HOLES
A15408 2910	8
A15408 2912	9
A15408 2914	10

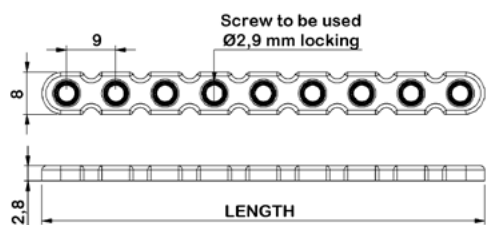

Intended use : Fixation of fractures, malunions, nonunions, pseudoarthroses and osteotomies of the sternum.

2,9 mm Universal Locking Straight Plate



TI	HOLES
A15408 2916	8
A15408 2918	24
A15408 2920	30

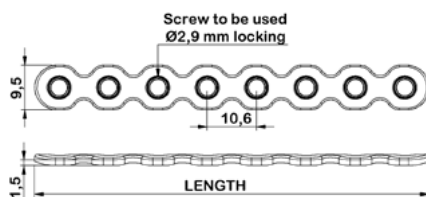

Intended use : Fixation of fractures, malunions, nonunions, pseudoarthroses and osteotomies of the ribs.

Chest Wall Plates, Screws & Splints

2,9 mm Self-Tapping Rib Locking Screw



TI	DIA. x LENGTH (mm)
A15409 2906	2,9X6
A15409 2908	2,9X8
A15409 2910	2,9X10
A15409 2912	2,9X12
A15409 2914	2,9X14
A15409 2916	2,9X16
A15409 2918	2,9X18
A15409 2920	2,9X20

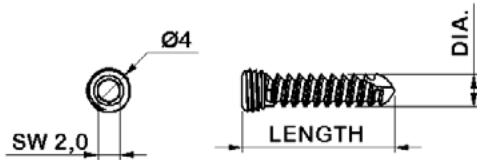

2,9 mm Self-Tapping Rib Screw



TI	DIA. x LENGTH (mm)
A15508 2910	2,9X10
A15508 2912	2,9X12

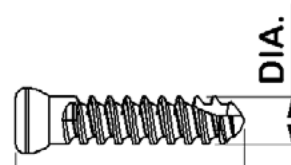

Rib Intramedullary Splints



TI	WIDTH (mm)	LENGTH (mm)
A100 02 222 0003	3	50
A100 02 222 0004	4	50
A100 02 222 0005	5	50
A100 02 222 0006	3	65
A100 02 222 0007	4	65
A100 02 222 0008	5	65
A100 02 222 0009	3	80
A100 02 222 0010	4	80
A100 02 222 0011	5	80

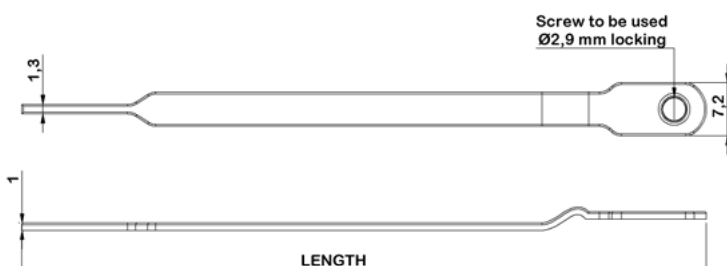

Intended use : Fixation of fractures, malunions, non-unions, pseudoarthroses and osteotomies of the ribs.

"We supply WORLD's
Orthopedic & Trauma
Implants..."

Angled Blade Plates & Pediatric Plates



Angled Blade Plates & Pediatric Plates

4,5 mm 135° Angled Blade Plate for operation on adult femur

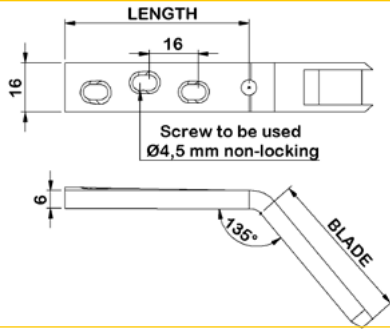

Intended use : Temporary fixation of fractures, malunions, nonunions, pseudoarthroses and osteotomies of the proximal femur for adult patients

SS	HOLES	BLADE (mm)	LENGTH (mm)	SS	HOLES	BLADE (mm)	LENGTH (mm)
A100 02 040 4050	4	50	76	A100 02 140 1280	7	80	124
A100 02 040 4060	4	60	76	A100 02 140 1290	7	90	124
A100 02 040 4070	4	70	76	A100 02 140 1200	7	100	124
A100 02 040 4080	4	80	76	A100 02 141 9050	8	50	140
A100 02 040 4090	4	90	76	A100 02 141 9060	8	60	140
A100 02 040 4100	4	100	76	A100 02 141 9070	8	70	140
A100 02 041 4050	5	50	92	A100 02 141 9080	8	80	140
A100 02 041 4060	5	60	92	A100 02 141 9090	8	90	140
A100 02 041 4070	5	70	92	A100 02 141 9100	8	100	140
A100 02 041 4080	5	80	92	A100 02 041 9050	9	50	156
A100 02 041 4090	5	90	92	A100 02 041 9060	9	60	156
A100 02 041 4100	5	100	92	A100 02 041 9070	9	70	156
A100 02 040 1250	6	50	108	A100 02 041 9080	9	80	156
A100 02 040 1260	6	60	108	A100 02 041 9090	9	90	156
A100 02 040 1270	6	70	108	A100 02 041 9100	9	100	156
A100 02 040 1280	6	80	108	A100 02 041 1250	12	50	204
A100 02 040 1290	6	90	108	A100 02 041 1260	12	60	204
A100 02 040 1200	6	100	108	A100 02 041 1270	12	70	204
A100 02 140 1250	7	50	124	A100 02 041 1280	12	80	204
A100 02 140 1260	7	60	124	A100 02 041 1290	12	90	204
A100 02 140 1270	7	70	124	A100 02 041 1200	12	100	204

4,5 mm 95° Angled Blade Plate for operation on adult femur

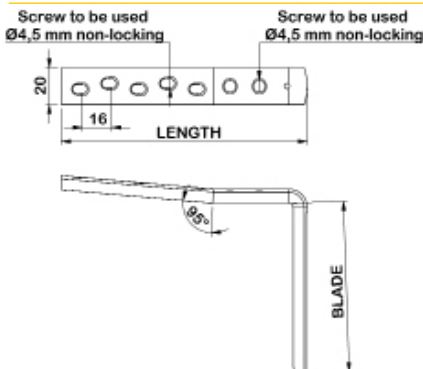

Intended use : Temporary fixation of fractures, malunions, nonunions, pseudoarthroses and osteotomies of the proximal femur for adult patients

SS	HOLES	BLADE (mm)	LENGTH (mm)	SS	HOLES	BLADE (mm)	LENGTH (mm)
A100 02 140 4050	4	50	86	A100 02 140 6080	7	80	134
A100 02 140 4060	4	60	86	A100 02 140 7065	7	90	134
A100 02 140 4070	4	70	86	A100 02 140 7085	7	100	134
A100 02 140 4080	4	80	86	A100 02 140 8050	8	50	150
A100 02 140 4090	4	90	86	A100 02 140 8060	8	60	150
A100 02 140 4100	4	100	86	A100 02 140 8070	8	70	150
A100 02 141 4050	5	50	102	A100 02 140 8080	8	80	150
A100 02 141 4060	5	60	102	A100 02 141 6090	8	90	150
A100 02 141 4070	5	70	102	A100 02 141 6100	8	100	150
A100 02 141 4080	5	80	102	A100 02 140 9050	9	50	166
A100 02 141 4090	5	90	102	A100 02 140 9060	9	60	166
A100 02 141 4100	5	100	102	A100 02 140 9070	9	70	166
A100 02 140 6051	6	50	118	A100 02 140 9080	9	80	166
A100 02 140 6061	6	60	118	A100 02 140 9090	9	90	166
A100 02 140 6071	6	70	118	A100 02 140 9100	9	100	166
A100 02 140 6081	6	80	118	A100 02 141 1250	12	50	214
A100 02 140 6090	6	90	118	A100 02 141 1260	12	60	214
A100 02 140 6100	6	100	118	A100 02 141 1270	12	70	214
A100 02 140 6050	7	50	134	A100 02 141 1280	12	80	214
A100 02 140 6060	7	60	134	A100 02 141 1290	12	90	214
A100 02 140 6070	7	70	134	A100 02 141 1200	12	100	214

Angled Blade Plates & Pediatric Plates

4,5 mm 90° Angled Blade Plate Adolescent

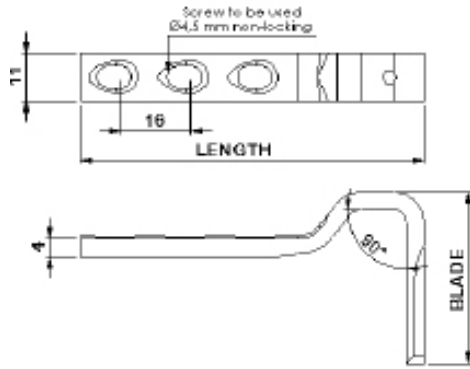

SS	HOLES	BLADE (mm)	LENGTH (mm)
A100 02 070 1040	3	40	78,5
A100 02 070 1045	3	45	78,5
A100 02 070 1050	3	50	78,5
A100 02 070 1055	3	55	78,5
A100 02 070 1060	3	60	78,5

Intended use : Temporary fixation of fractures, malunions, nonunions, pseudoarthroses and osteotomies of the proximal femur in children. Especially used for fixation of subtrochanteric varus osteotomies in treatment of congenital dislocation of hip in adolescents.

3,5 mm 90° Angled Blade Plate Pediatric

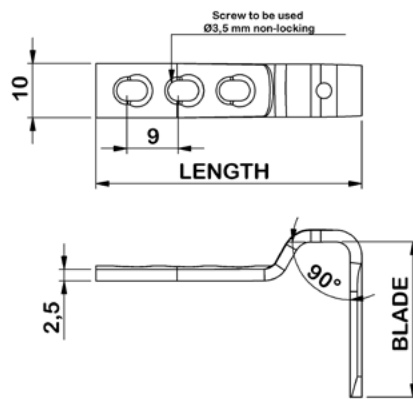

SS	HOLES	BLADE (mm)	LENGTH (mm)
A100 02 050 1225	3	25	51,7
A100 02 050 1230	3	30	51,7
A100 02 050 1232	3	32	51,7
A100 02 050 1235	3	35	51,7

Intended use : Temporary fixation of fractures, malunions, nonunions, pseudoarthroses and osteotomies of the proximal femur in children. Especially used for fixation of subtrochanteric varus osteotomies in treatment of congenital dislocation of hip in children.

3,5 mm Mini Pediatric Locking Plate 100°

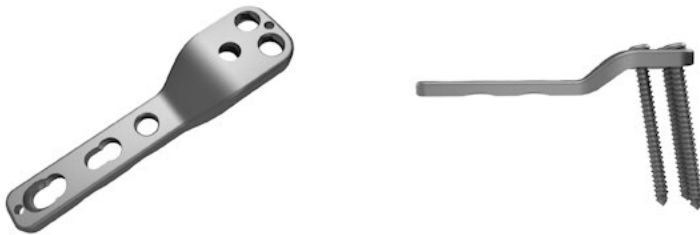

SS	TI	HOLES	LENGTH (mm)
A100 02 051 0725	A100 02 051 0730	3	64

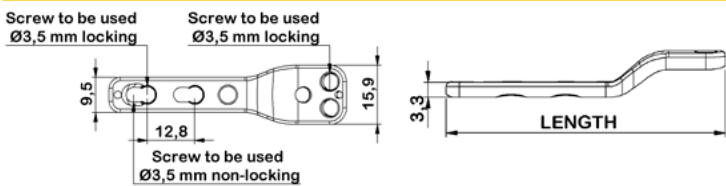

Intended use : Temporary fixation of fractures, malunions, nonunions, pseudoarthroses and osteotomies of the proximal femur in children. Especially used for fixation of subtrochanteric varus osteotomies in treatment of congenital dislocation of hip in children.

Angled Blade Plates & Pediatric Plates

3,5 mm Pediatric Locking Plate 100°

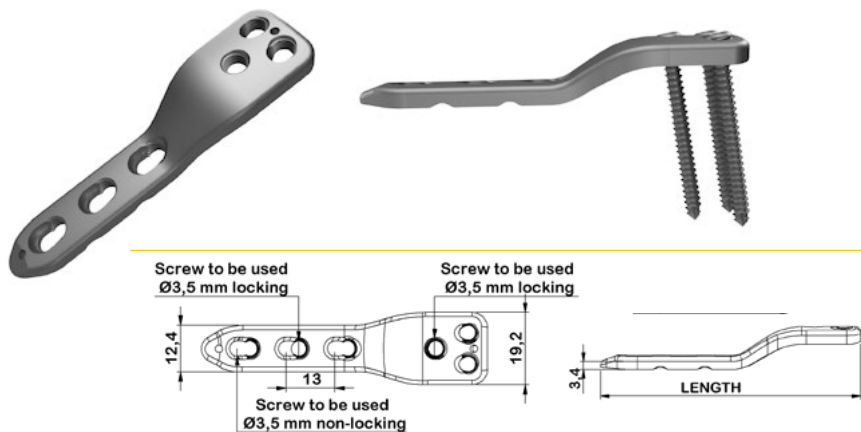

SS	TI	HOLES	LENGTH (mm)
A100 02 051 0732	A100 02 051 0735	3	76

Intended use : Temporary fixation of fractures, malunions, nonunions, pseudoarthroses and osteotomies of the proximal femur in children. Especially used for fixation of subtrochanteric varus osteotomies in treatment of congenital dislocation of hip in children

3,5 mm Pediatric Locking Plate 110°

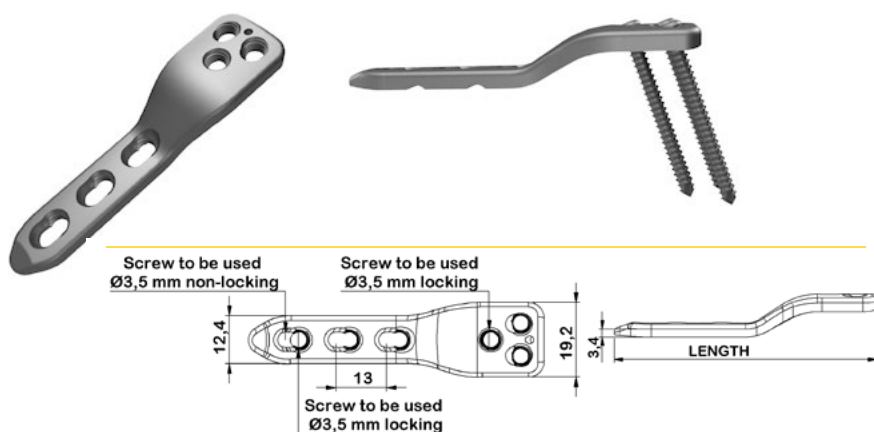

SS	TI	HOLES	LENGTH (mm)
A100 02 051 1232	A100 02 051 1235	3	76

Intended use : Temporary fixation of fractures, malunions, nonunions, pseudoarthroses and osteotomies of the proximal femur in children. Especially used for fixation of subtrochanteric varus osteotomies in treatment of congenital dislocation of hip in children.

3,5 mm Pediatric Locking Plate 150°

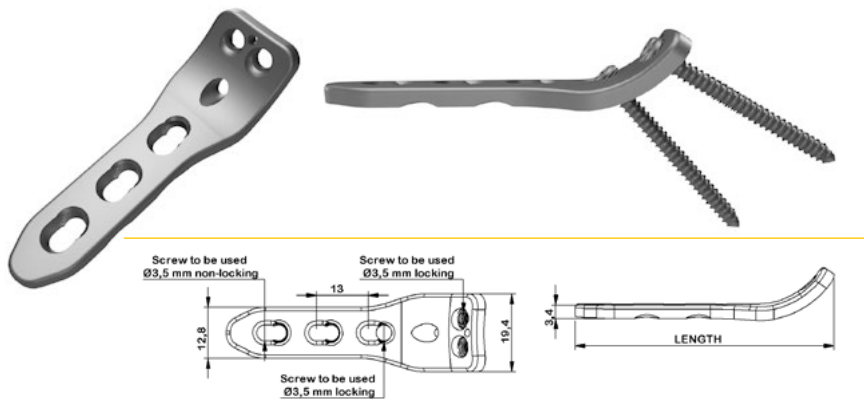

SS	TI	HOLES	LENGTH (mm)
A100 02 050 0725	A100 02 050 0730	3	65

Intended use : Temporary fixation of fractures, malunions, nonunions, pseudoarthroses and osteotomies of the proximal femur in children. Especially used for fixation of subtrochanteric valgus osteotomies in treatment of congenital dislocation of hip in children.

Pediatric Eight Plate (for epiphysiodesis)

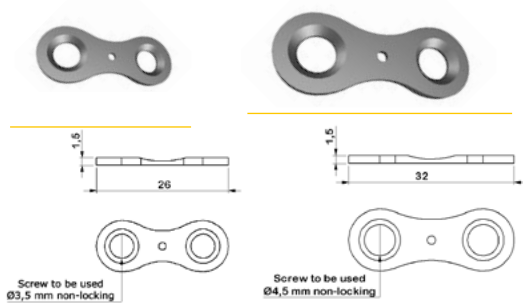

TI	TYPE
A100 02 050 0732	Small
A100 02 050 0735	Large

Intended use : Gradual correction of pediatric deformities in both the upper and lower extremities.

"We supply WORLD's
Orthopedic & Trauma
Implants..."

Trochanteric Plates & Cable Systems



Trochanteric Plates & Cable Systems

4,5/5,0 mm Straight Cable Grip Plate



SS	TYPE
A900 04 020 0051	Small
A900 04 020 0052	Medium
A900 04 020 0053	Large

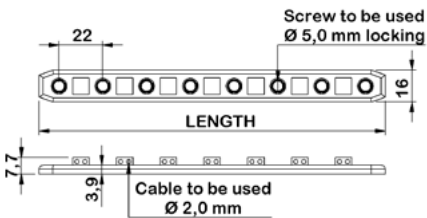

Intended use : Temporary fixation of fractures, malunions, nonunions, pseudoarthroses and osteotomies of the proximal femur and femoral shaft, especially in periprosthetic fractures. This plate group is used together with screws, cables and crimp blocks.

4,5/5,0 mm Trochanteric Hook Cable Plate 1



TI	TYPE
A900 04 021 0051	Small
A900 04 021 0052	Medium
A900 04 021 0053	Large

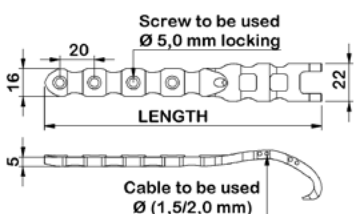

Intended use : Temporary fixation of fractures, malunions, nonunions, pseudoarthroses and osteotomies of the proximal femur and femoral shaft, especially in periprosthetic fractures. This plate group is used together with screws, cables and crimp blocks.

Trochanteric Plates & Cable Systems

4,5/5,0 mm Trochanteric Cable Hook Plate 2



TI	TYPE
A900 04 023 0051	Small
A900 04 023 0052	Medium
A900 04 023 0053	Large

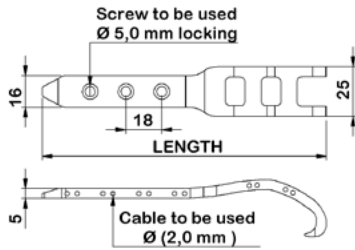

Intended use : Temporary fixation of fractures, malunions, nonunions, pseudoarthroses and osteotomies of the proximal femur and femoral shaft, especially in periprosthetic fractures. This plate group is used together with screws, cables and crimp blocks.

Trochanteric Cable Hook Grip Plate



SS	TYPE
A900 04 022 0051	Small
A900 04 022 0052	Medium
A900 04 022 0053	Large

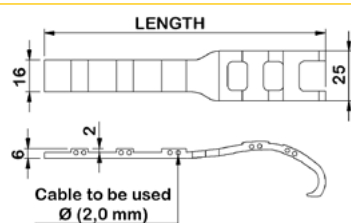

Intended use : Temporary fixation of fractures, malunions, nonunions, pseudoarthroses and osteotomies of the proximal femur. Especially used for fixation of periprosthetic fractures. This plate group is used together with cables and crimp blocks.

Trochanteric Plates & Cable Systems

Trochanteric Grip



SS/TI

A900 04 020 0050

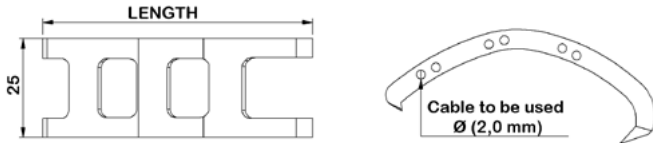

Intended use : Temporary fixation of fractures, malunions, nonunions, pseudoarthroses and osteotomies of the proximal femur. Especially used for fixation of periprosthetic fractures. This plate group is used together with cables and crimp blocks.

3,5 mm Cable Locking Screw



TI

A900 03 020 0005

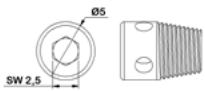

Intended use : Fixation of cables used together with 3,5 mm locking plates.

5,0 mm Cable Locking Screw



TI

A900 03 020 0008

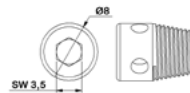

Intended use : Fixation of cables used together with 5,0 mm locking plates.

Cable Crimp Block

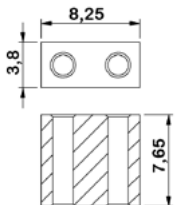

Intended use : Temporary fixation of fractures, malunions, nonunions, pseudoarthroses and osteotomies of the trochanteric region of proximal femur. Especially used for fixation of periprosthetic fractures. This grip is used together with cables and crimp blocks.

SS	TYPE
A900 03 015 0015	Cable 1,5 mm
A900 03 020 0020	Cable 2,0 mm
A900 04 015 0015	Crimp Block 1,5 mm
A900 04 020 0020	Crimp Block 2,0 mm



"We supply WORLD's
Orthopedic & Trauma
Implants..."

Cannulated Screws



Cannulated Screws

2,7 mm Cannulated Screw Partially Threaded



TI	DIA. x LENGTH (mm)
A6072718	2,7X18
A6072720	2,7X20
A6072722	2,7X22
A6072724	2,7X24
A6072726	2,7X26
A6072728	2,7X28
A6072730	2,7X30



Intended use : Temporary fixation of fractures and arthrodeses of small bones & joints eg. ;
 -fractures of forearm, hand and foot (distal radius, carpal, metacarpal, tarsal, metatarsal bones
 -arthrodeses of forearm, hand and foot (intercarpal, intertarsal, interphalangeal, metacarpophalangeal, metatarsophalangeal Joints)

3,5 mm Cannulated Screw Partially Threaded



TI	DIA. x LENGTH (mm)	TI	DIA. x LENGTH (mm)
A6073516	3,5X16	A6073534	3,5X34
A6073518	3,5X18	A6073536	3,5X36
A6073520	3,5X20	A6073538	3,5X38
A6073522	3,5X22	A6073540	3,5X40
A6073524	3,5X24	A6073542	3,5X42
A6073526	3,5X26	A6073544	3,5X44
A6073528	3,5X28	A6073546	3,5X46
A6073530	3,5X30	A6073548	3,5X48
A6073532	3,5X32	A6073550	3,5X50



Intended use : Temporary fixation of fractures and arthrodeses of small bones & joints eg. ;
 -fractures of forearm, hand and foot (distal radius, carpal, metacarpal, tarsal, metatarsal bones
 -arthrodeses of forearm, hand and foot (intercarpal, intertarsal, interphalangeal, metacarpophalangeal, metatarsophalangeal Joints)

3,5 mm Cannulated Screw Full Threaded



TI	DIA. x LENGTH (mm)	TI	DIA. x LENGTH (mm)
A6083514	3,5X14	A6083534	3,5X34
A6083516	3,5X16	A6083536	3,5X36
A6083518	3,5X18	A6083538	3,5X38
A6083520	3,5X20	A6083540	3,5X40
A6083522	3,5X22	A6083542	3,5X42
A6083524	3,5X24	A6083544	3,5X44
A6083526	3,5X26	A6083546	3,5X46
A6083528	3,5X28	A6083548	3,5X48
A6083530	3,5X30	A6083550	3,5X50
A6083532	3,5X32		

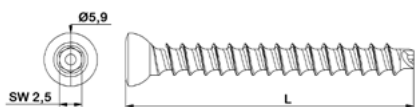

Intended use : Temporary fixation of fractures and arthrodeses of small bones & joints eg. ;
 -fractures of forearm, hand and foot (distal radius, carpal, metacarpal, tarsal, metatarsal bones
 -arthrodeses of forearm, hand and foot (intercarpal, intertarsal, interphalangeal, metacarpophalangeal, metatarsophalangeal Joints)

Cannulated Screws

4,0 mm Cannulated Screw Partially Threaded



TI	DIA. x LENGTH (mm)	TI	DIA. x LENGTH (mm)
A6074020	4,0X20	A6074046	4,0X46
A6074022	4,0X22	A6074048	4,0X48
A6074024	4,0X24	A6074050	4,0X50
A6074026	4,0X26	A6074052	4,0X52
A6074028	4,0X28	A6074054	4,0X54
A6074030	4,0X30	A6074056	4,0X56
A6074032	4,0X32	A6074058	4,0X58
A6074034	4,0X34	A6074060	4,0X60
A6074036	4,0X36	A6074062	4,0X62
A6074038	4,0X38	A6074064	4,0X64
A6074040	4,0X40	A6074066	4,0X66
A6074042	4,0X42	A6074068	4,0X68
A6074044	4,0X44	A6074070	4,0X70



Intended use :

- Temporary fixation of fractures with medium fragments, e.g.:
- tarsal and metatarsal fractures and fixation in tarsal, metatarsal osteotomies,
 - tarsometatarsal and metatarsophalangeal arthrodeses,
 - ligament fixation,
 - hallux valgus correction osteotomies

4,0 mm Cannulated Screw Full Threaded



TI	DIA. x LENGTH (mm)	TI	DIA. x LENGTH (mm)
A6084020	4,0X20	A6084046	4,0X46
A6084022	4,0X22	A6084048	4,0X48
A6084024	4,0X24	A6084050	4,0X50
A6084026	4,0X26	A6084052	4,0X52
A6084028	4,0X28	A6084054	4,0X54
A6084030	4,0X30	A6084056	4,0X56
A6084032	4,0X32	A6084058	4,0X58
A6084034	4,0X34	A6084060	4,0X60
A6084036	4,0X36	A6084062	4,0X62
A6084038	4,0X38	A6084064	4,0X64
A6084040	4,0X40	A6084066	4,0X66
A6084042	4,0X42	A6084068	4,0X68
A6084044	4,0X44	A6084070	4,0X70

Intended use :

- Temporary fixation of fractures with medium fragments, e.g.:
- tarsal and metatarsal fractures and fixation in tarsal, metatarsal osteotomies,
 - tarsometatarsal and metatarsophalangeal arthrodeses,
 - ligament fixation,
 - hallux valgus correction osteotomies

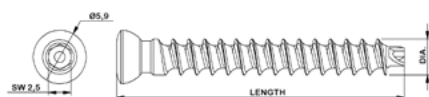

Cannulated Screws

4,5 mm Cannulated Screw Partially Threaded



SS	TI	DIA. x LENGTH (mm)	SS	TI	DIA. x LENGTH (mm)
A030120	A6074220	4,5X20	A030140	A6074240	4,5X40
A030122	A6074222	4,5X22	A030142	A6074242	4,5X42
A030124	A6074224	4,5X24	A030144	A6074244	4,5X44
A030126	A6074226	4,5X26	A030146	A6074246	4,5X46
A030128	A6074228	4,5X28	A030148	A6074248	4,5X48
A030130	A6074230	4,5X30	A030150	A6074250	4,5X50
A030132	A6074232	4,5X32	A030152	A6074252	4,5X52
A030134	A6074234	4,5X34	A030154	A6074254	4,5X54
A030136	A6074236	4,5X36	A030156	A6074256	4,5X56
A030138	A6074238	4,5X38	A030158	A6074258	4,5X58
			A030160	A6074260	4,5X60



Intended use : Temporary fixation of fractures with medium fragments, e.g.:

- malleolar fractures
- pilon tibial fractures
- fractures of the calcaneus and talus
- tibial plateau fractures
- carpal and tarsal arthrodeses

4,5 mm Cannulated Screw Full Threaded



SS	TI	DIA. x LENGTH (mm)	SS	TI	DIA. x LENGTH (mm)
A040120	A6074520	4,5X20	A040142	A6074542	4,5X42
A040122	A6074522	4,5X22	A040144	A6074544	4,5X44
A040124	A6074524	4,5X24	A040146	A6074546	4,5X46
A040126	A6074526	4,5X26	A040148	A6074548	4,5X48
A040128	A6074528	4,5X28	A040150	A6074550	4,5X50
A040130	A6074530	4,5X30	A040152	A6074552	4,5X52
A040132	A6074532	4,5X32	A040154	A6074554	4,5X54
A040134	A6074534	4,5X34	A040156	A6074556	4,5X56
A040136	A6074536	4,5X36	A040158	A6074558	4,5X58
A040138	A6074538	4,5X38	A040160	A6074560	4,5X60
A040140	A6074540	4,5X40			

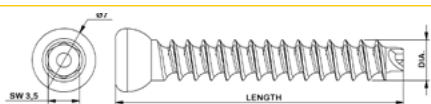

Intended use : Temporary fixation of fractures with medium fragments, e.g.:

- malleolar fractures
- pilon tibial fractures
- fractures of the calcaneus and talus
- tibial plateau fractures
- carpal and tarsal arthrodeses

Cannulated Screws

6,5 mm Cannulated Screw 16 mm Threaded

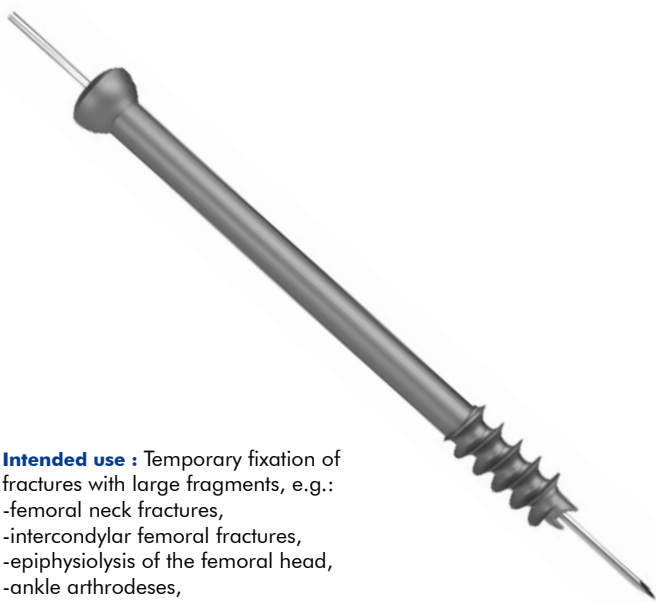

Intended use : Temporary fixation of fractures with large fragments, e.g.:

- femoral neck fractures,
- intercondylar femoral fractures,
- epiphysiolysis of the femoral head,
- ankle arthrodeses,
- iliosacral dislocations,
- proximal tibia plateau fractures



SS	TI	DIA. x LENGTH (mm)
A 101 04 225 0300	A 111 04 225 0300	6,5X30
A 101 04 225 0350	A 111 04 225 0350	6,5X35
A 101 04 225 0400	A 111 04 225 0400	6,5X40
A 101 04 225 0450	A 111 04 225 0450	6,5X45
A 101 04 225 0500	A 111 04 225 0500	6,5X50
A 101 04 225 0550	A 111 04 225 0550	6,5X55
A 101 04 225 0600	A 111 04 225 0600	6,5X60
A 101 04 225 0650	A 111 04 225 0650	6,5X65
A 101 04 225 0700	A 111 04 225 0700	6,5X70
A 101 04 225 0750	A 111 04 225 0750	6,5X75
A 101 04 225 0800	A 111 04 225 0800	6,5X80
A 101 04 225 0850	A 111 04 225 0850	6,5X85
A 101 04 225 0900	A 111 04 225 0900	6,5X90
A 101 04 225 0950	A 111 04 225 0950	6,5X95
A 101 04 225 1000	A 111 04 225 1000	6,5X100
A 101 04 225 1050	A 111 04 225 1050	6,5X105
A 101 04 225 1100	A 111 04 225 1100	6,5X110
A 101 04 225 1150	A 111 04 225 1150	6,5X115
A 101 04 225 1200	A 111 04 225 1200	6,5X120

6,5 mm Cannulated Screw 32 mm Threaded

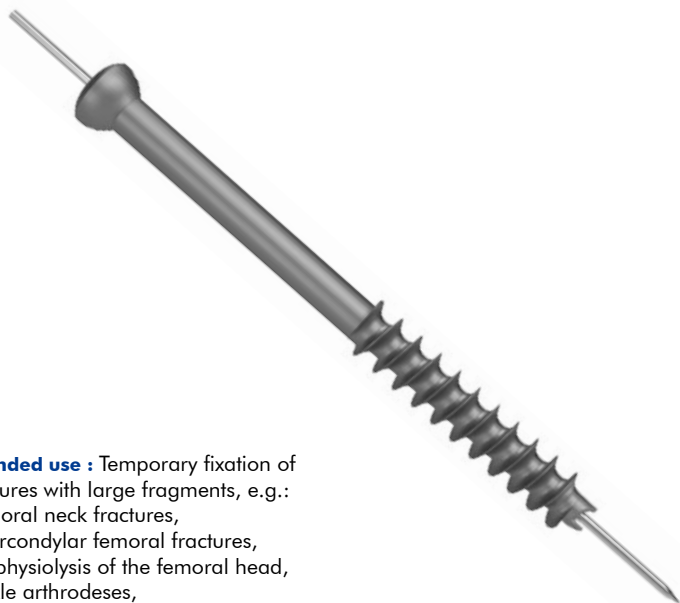

Intended use : Temporary fixation of fractures with large fragments, e.g.:

- femoral neck fractures,
- intercondylar femoral fractures,
- epiphysiolysis of the femoral head,
- ankle arthrodeses,
- iliosacral dislocations,
- proximal tibia plateau fractures



SS	TI	DIA. x LENGTH (mm)
A 101 04 300 0500	A 111 04 300 0500	6,5X50
A 101 04 300 0550	A 111 04 300 0550	6,5X55
A 101 04 300 0600	A 111 04 300 0600	6,5X60
A 101 04 300 0650	A 111 04 300 0650	6,5X65
A 101 04 300 0700	A 111 04 300 0700	6,5X70
A 101 04 300 0750	A 111 04 300 0750	6,5X75
A 101 04 300 0800	A 111 04 300 0800	6,5X80
A 101 04 300 0850	A 111 04 300 0850	6,5X85
A 101 04 300 0900	A 111 04 300 0900	6,5X90
A 101 04 300 0950	A 111 04 300 0950	6,5X95
A 101 04 300 1000	A 111 04 300 1000	6,5X100
A 101 04 300 1050	A 111 04 300 1050	6,5X105
A 101 04 300 1100	A 111 04 300 1100	6,5X110
A 101 04 300 1150	A 111 04 300 1150	6,5X115
A 101 04 300 1200	A 111 04 300 1200	6,5X120

Cannulated Screws

6,5 mm Cannulated Screw Full Threaded



SS	TI	DIA. x LENGTH (mm)	SS	TI	DIA. x LENGTH (mm)
A101 04 330 0350	A111 04 330 0350	6,5X35	A101 04 330 0800	A111 04 330 0800	6,5X80
A101 04 330 0400	A111 04 330 0400	6,5X40	A101 04 330 0850	A111 04 330 0850	6,5X85
A101 04 330 0450	A111 04 330 0450	6,5X45	A101 04 330 0900	A111 04 330 0900	6,5X90
A101 04 330 0500	A111 04 330 0500	6,5X50	A101 04 330 0950	A111 04 330 0950	6,5X95
A101 04 330 0550	A111 04 330 0550	6,5X55	A101 04 330 1000	A111 04 330 1000	6,5X100
A101 04 330 0600	A111 04 330 0600	6,5X60	A101 04 330 1050	A111 04 330 1050	6,5X105
A101 04 330 0650	A111 04 330 0650	6,5X65	A101 04 330 1100	A111 04 330 1100	6,5X110
A101 04 330 0700	A111 04 330 0700	6,5X70	A101 04 330 1150	A111 04 330 1150	6,5X115
A101 04 330 0750	A111 04 330 0750	6,5X75	A101 04 330 1200	A111 04 330 1200	6,5X120

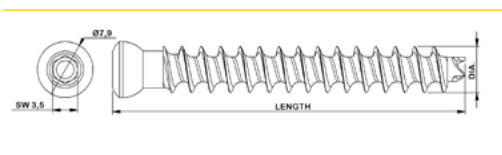

Intended use : Temporary fixation of fractures with large fragments, e.g.:

- femoral neck fractures,
- intercondylar femoral fractures,
- epiphysiolysis of the femoral head,
- ankle arthrodeses,
- iliosacral dislocations,
- proximal tibia plateau fractures

7,3 mm Cannulated Screw 16 mm Threaded



SS	TI	DIA. x LENGTH (mm)	SS	TI	DIA. x LENGTH (mm)
A6049050	A6048050	7,3X50	A6049090	A6048090	7,3X90
A6049055	A6048055	7,3X55	A6049095	A6048095	7,3X95
A6049060	A6048060	7,3X60	A6049100	A6048100	7,3X100
A6049065	A6048065	7,3X65	A6049105	A6048105	7,3X105
A6049070	A6048070	7,3X70	A6049110	A6048110	7,3X110
A6049075	A6048075	7,3X75	A6049115	A6048115	7,3X115
A6049080	A6048080	7,3X80	A6049120	A6048120	7,3X120
A6049085	A6048085	7,3X85			



Intended use : Temporary fixation of fractures with large fragments, e.g.:

- femoral neck fractures,
- intercondylar femoral fractures,
- epiphysiolysis of the femoral head,
- ankle arthrodeses,
- iliosacral dislocations,
- proximal tibia plateau fractures

Cannulated Screws

7,3 mm Cannulated Screw 32 mm Threaded



SS	TI	DIA. x LENGTH (mm)	SS	TI	DIA. x LENGTH (mm)
A6059050	A6058050	7,3X50	A6059090	A6058090	7,3X90
A6059055	A6058055	7,3X55	A6059095	A6058095	7,3X95
A6059060	A6058060	7,3X60	A6059100	A6058100	7,3X100
A6059065	A6058065	7,3X65	A6059105	A6058105	7,3X105
A6059070	A6058070	7,3X70	A6059110	A6058110	7,3X110
A6059075	A6058075	7,3X75	A6059115	A6058115	7,3X115
A6059080	A6058080	7,3X80	A6059120	A6058120	7,3X120
A6059085	A6058085	7,3X85			

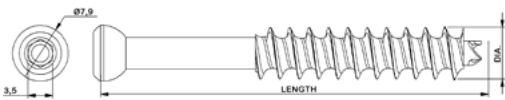

Intended use : Temporary fixation of fractures with large fragments, e.g.:

- femoral neck fractures,
- intercondylar femoral fractures,
- epiphysiolysis of the femoral head,
- ankle arthrodeses,
- iliosacral dislocations,
- proximal tibia plateau fractures

Washer Ø13

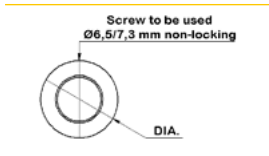

TI	DIA. (mm)
A110 04 000 0014	13

Washer Ø10

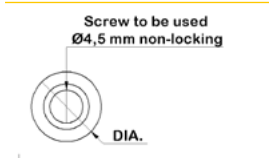

SS	DIA. (mm)
A110 04 000 0010	10

Washer Ø8,0

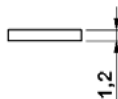
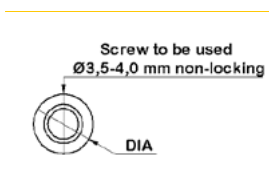

SS	TI	DIA. (mm)
A34004108	A34004008	8

■ www.aysam.com.tr
■ www.aysamstore.com.tr
■ aysam@aysam.com.tr
f [aysam.orthopedics](https://www.facebook.com/aysam.orthopedics)
t [aysamortho](https://www.instagram.com/aysamortho)
in [aysam](https://www.linkedin.com/company/aysam)
You Tube [aysam orthopaedics](https://www.youtube.com/channel/UC...)



"We supply WORLD's
Orthopedic & Trauma
Implants..."

Headless & Herbert Screws



Headless, Herbert Screw & Interference Screws

3,0 mm Headless Cannulated Compression Screw

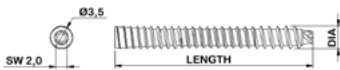

Intended use : Temporary fixation of fractures, malunions, nonunions, osteotomies, pseudoarthroses, arthrodesis, of the hand and foot bones(carpal, metacarpal, tarsal, metatarsal, phalanges bones), distal and proximal humerus, radius and ulna in adult and pediatric patients. Ligamentous injuries of small medium and large joints.

TI	DIA. x LENGTH (mm)
A6013014	3,0X14
A6013016	3,0X16
A6013018	3,0X18
A6013020	3,0X20
A6013022	3,0X22
A6013024	3,0X24
A6013026	3,0X26
A6013028	3,0X28
A6013030	3,0X30
A6013035	3,0X35
A6013040	3,0X40
A6013045	3,0X45
A6013050	3,0X50

3,5 mm Headless Cannulated Compression Screw

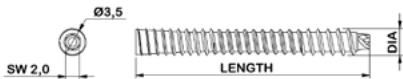

Intended use : Temporary fixation of fractures, malunions, nonunions, osteotomies, pseudoarthroses, arthrodesis, of the hand and foot bones(carpal, metacarpal, tarsal, metatarsal, phalanges bones), distal and proximal humerus, radius and ulna in adult and pediatric patients. Ligamentous injuries of small medium and large joints.

TI	DIA. x LENGTH (mm)
A6013514	3,5X14
A6013516	3,5X16
A6013518	3,5X18
A6013520	3,5X20
A6013522	3,5X22
A6013524	3,5X24
A6013526	3,5X26
A6013528	3,5X28
A6013530	3,5X30
A6013535	3,5X35
A6013540	3,5X40
A6013545	3,5X45
A6013550	3,5X50

4,0 mm Headless Cannulated Compression Screw

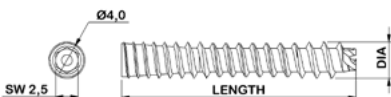

Intended use : Temporary fixation of fractures, malunions, nonunions, osteotomies, pseudoarthroses, arthrodesis, of the distal and proximal humerus, radius and ulna in adult and pediatric patients. Ligamentous injuries of small medium and large joints. Fixation of fractures with medium fragments, e.g.:

- malleolar fractures
- tibia pilon fractures
- fractures of the calcaneus and talus
- tibial plateau fractures
- carpal and tarsal arthrodes

TI	DIA. x LENGTH (mm)
A6014015	4,0X15
A6014020	4,0X20
A6014025	4,0X25
A6014030	4,0X30
A6014035	4,0X35
A6014040	4,0X40
A6014045	4,0X45
A6014050	4,0X50
A6014055	4,0X55
A6014060	4,0X60
A6014065	4,0X65
A6014070	4,0X70
A6014075	4,0X75

Headless, Herbert Screw & Interference Screws

5,0 mm Headless Cannulated Compression Screw



TI	DIA. x LENGTH (mm)
A6015030	5,0X30
A6015035	5,0X35
A6015040	5,0X40
A6015045	5,0X45
A6015050	5,0X50
A6015055	5,0X55
A6015060	5,0X60
A6015065	5,0X65
A6015070	5,0X70
A6015075	5,0X75
A6015080	5,0X80

Intended use : Temporary fixation of fractures, malunions, nonunions, osteotomies, pseudoarthroses, arthrodesis, of the, distal and proximal humerus, radius and ulna in adult and pediatric patients. ligamentous injuries of small medium and large joints. Fixation of fractures with medium fragments, e.g.:

- malleolar fractures
- tibia pilon fractures
- fractures of the calcaneus and talus
- tibial plateau fractures
- carpal and tarsal arthroses

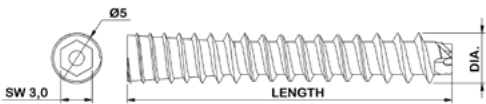

6,5 mm Headless Cannulated Compression Screw



TI	DIA. x LENGTH (mm)
A6016540	6,5X40
A6016545	6,5X45
A6016550	6,5X50
A6016555	6,5X55
A6016560	6,5X60
A6016565	6,5X65
A6016570	6,5X70
A6016575	6,5X75
A6016580	6,5X80
A6016585	6,5X85
A6016590	6,5X90

Intended use : Temporary fixation of fractures with large fragments, e.g.:

- femoral neck fractures
- intercondylar femoral fractures
- epiphyseolysis of the femoral head
- ankle arthroses
- iliosacral dislocations

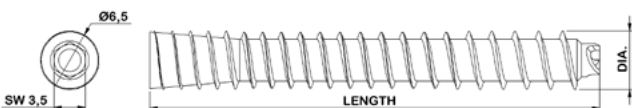

3,0/4,0 mm Herbert Screw



TI	LENGTH (mm)
A34.114	14
A34.116	16
A34.118	18
A34.120	20
A34.122	22
A34.124	24
A34.126	26
A34.128	28
A34.130	30
A34.132	32

Intended use : Temporary fixation of fractures, malunions, nonunions, osteotomies, pseudoarthroses, arthrodesis, of the, hand and foot bones (carpal, metacarpal, tarsal, metatarsal, phalanges bones), distal and proximal humerus, radius and ulna in adult and pediatric patients. Ligamentous injuries of small medium and large joints.

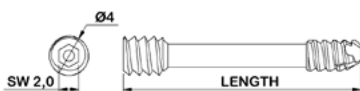

Headless, Herbert Screw & Interference Screws

Interference Screw

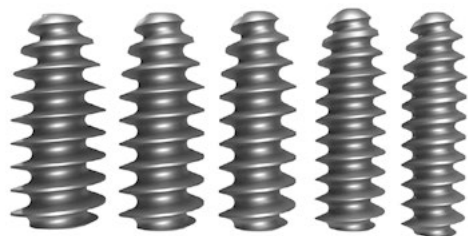

TI	Diameter (mm)	LENGTH (mm)	LENGTH (mm)	LENGTH (mm)
A6072710	7	20	25	30
A6072712	8	20	25	30
A6072714	9	20	25	30
A6072716	10	20	25	30
A6072732	11	20	25	30

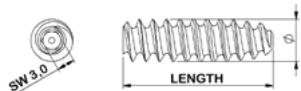

Intended use : Temporary fixation of both bone-patellar tendon-bone (BTB) and soft tissue grafts in ACL and PCL reconstructions.



"We supply WORLD's
Orthopedic & Trauma
Implants..."

Intramedullary Nails



Intramedullary Nails/Humerus

Humerus Intramedullary Nail

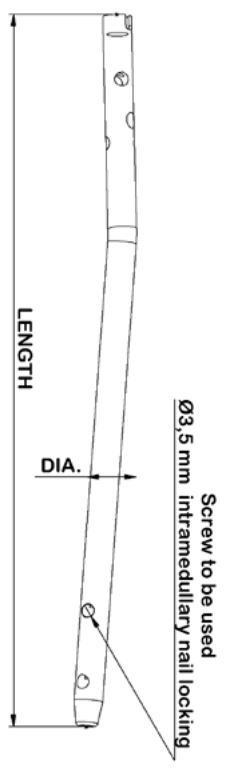

Intended use : Temporary fixation of fractures, osteotomies, nonunions, malunions, pseudoarthroses of humerus. Especially used in humeral shaft fractures.

SS	TI	DIA x LENGTH (mm)
A100 03 036 0718	A100 03 035 0718	7X180
A100 03 036 0720	A100 03 035 0720	7X200
A100 03 036 0722	A100 03 035 0722	7X220
A100 03 036 0724	A100 03 035 0724	7X240
A100 03 036 0726	A100 03 035 0726	7X260
A100 03 036 0728	A100 03 035 0728	7X280
A100 03 036 0730	A100 03 035 0730	7X300
A100 03 036 0732	A100 03 035 0732	7X320
A100 03 036 0818	A100 03 035 0818	8X180
A100 03 036 0820	A100 03 035 0820	8X200
A100 03 036 0822	A100 03 035 0822	8X220
A100 03 036 0824	A100 03 035 0824	8X240
A100 03 036 0826	A100 03 035 0826	8X260
A100 03 036 0828	A100 03 035 0828	8X280
A100 03 036 0830	A100 03 035 0830	8X300
A100 03 036 0832	A100 03 035 0832	8X320
A100 03 036 1018	A100 03 035 1018	8,5X180
A100 03 036 1020	A100 03 035 1020	8,5X200
A100 03 036 1022	A100 03 035 1022	8,5X220
A100 03 036 1024	A100 03 035 1024	8,5X240
A100 03 036 1026	A100 03 035 1026	8,5X260
A100 03 036 1028	A100 03 035 1028	8,5X280
A100 03 036 1030	A100 03 035 1030	8,5X300
A100 03 036 1032	A100 03 035 1032	8,5X320
A100 03 036 0918	A100 03 035 0918	9X180
A100 03 036 0920	A100 03 035 0920	9X200
A100 03 036 0922	A100 03 035 0922	9X220
A100 03 036 0924	A100 03 035 0924	9X240
A100 03 036 0926	A100 03 035 0926	9X260
A100 03 036 0928	A100 03 035 0928	9X280
A100 03 036 0930	A100 03 035 0930	9X300
A100 03 036 0932	A100 03 035 0932	9X320

3,5 mm Intramedullary Nail Locking Screw

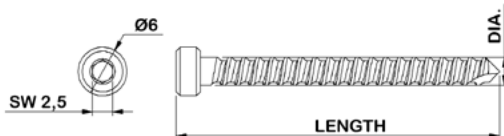

SS	TI	DIA x LENGTH (mm)
A101 03 036 4020	A101 03 035 4020	3,5X20
A101 03 036 4025	A101 03 035 4025	3,5X25
A101 03 036 4030	A101 03 035 4030	3,5X30
A101 03 036 4035	A101 03 035 4035	3,5X35
A101 03 036 4040	A101 03 035 4040	3,5X40
A101 03 036 4045	A101 03 035 4045	3,5X45
A101 03 036 4050	A101 03 035 4050	3,5X50

Humerus Intramedullary Nail End Cap



SS	TI
A100 03 201 0000	A100 03 202 0000

Intramedullary Nails/Femur

Femur Intramedullary Nail (ANTEGRADE)

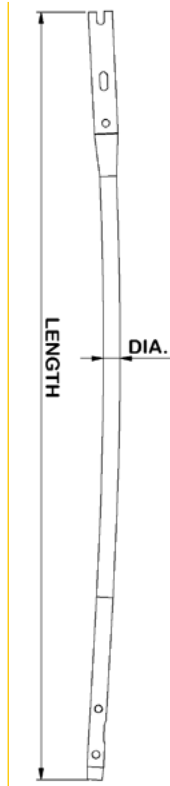

Intended use :
Temporary fixation of fractures, osteotomies, nonunions, malunions, pseudoarthroses of femur. Especially used in femoral shaft fractures.

SS	TI	DIA x LENGTH (mm)	SS	TI	DIA x LENGTH (mm)
A4099320	A4089320	9X320	A4090320	A4080320	10X320
A4099340	A4089340	9X340	A4090340	A4080340	10X340
A4099360	A4089360	9X360	A4090360	A4080360	10X360
A4099380	A4089380	9X380	A4090380	A4080380	10X380
A4099400	A4089400	9X400	A4090400	A4080400	10X400
A4099420	A4089420	9X420	A4090420	A4080420	10X420
A4099440	A4089440	9X440	A4090440	A4080440	10X440
A4099460	A4089460	9X460	A4090460	A4080460	10X460
A4091320	A4081320	11X320	A4092320	A4082320	12X320
A4091340	A4081340	11X340	A4092340	A4082340	12X340
A4091360	A4081360	11X360	A4092360	A4082360	12X360
A4091380	A4081380	11X380	A4092380	A4082380	12X380
A4091400	A4081400	11X400	A4092400	A4082400	12X400
A4091420	A4081420	11X420	A4092420	A4082420	12X420
A4091440	A4081440	11X440	A4092440	A4082440	12X440
A4091460	A4081460	11X460	A4092460	A4082460	12X460
A4093320	A4083320	13X320	A4094320	A4084320	14X320
A4093340	A4083340	13X340	A4094340	A4084340	14X340
A4093360	A4083360	13X360	A4094360	A4084360	14X360
A4093380	A4083380	13X380	A4094380	A4084380	14X380
A4093400	A4083400	13X400	A4094400	A4084400	14X400
A4093420	A4083420	13X420	A4094420	A4084420	14X420
A4093440	A4083440	13X440	A4094440	A4084440	14X440
A4093460	A4083460	13X460	A4094460	A4084460	14X460
A4095320	A4085320	15X320	A4096320	A4086320	16X320
A4095340	A4085340	15X340	A4096340	A4086340	16X340
A4095360	A4085360	15X360	A4096360	A4086360	16X360
A4095380	A4085380	15X380	A4096380	A4086380	16X380
A4095400	A4085400	15X400	A4096400	A4086400	16X400
A4095420	A4085420	15X420	A4096420	A4086420	16X420
A4095440	A4085440	15X440	A4096440	A4086440	16X440
A4095460	A4085460	15X460	A4096460	A4086460	16X460

Femur Intramedullary Nail End Cap



SS	TI
A100 03 040 4900	A100 03 040 5000

4,5 mm Intramedullary Nail Locking Screw

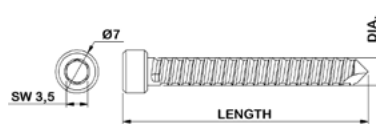

SS	TI	DIA x LENGTH (mm)
A4194020	A4184020	4,5X20
A4194025	A4184025	4,5X25
A4194030	A4184030	4,5X30
A4194035	A4184035	4,5X35
A4194040	A4184040	4,5X40
A4194045	A4184045	4,5X45
A4194050	A4184050	4,5X50
A4194055	A4184055	4,5X55
A4194060	A4184060	4,5X60
A4194065	A4184065	4,5X65
A4194070	A4184070	4,5X70
A4194075	A4184075	4,5X75

Intramedullary Nails/Femur

Distal Femur Intramedullary Nail (DFN / RETROGRADE)

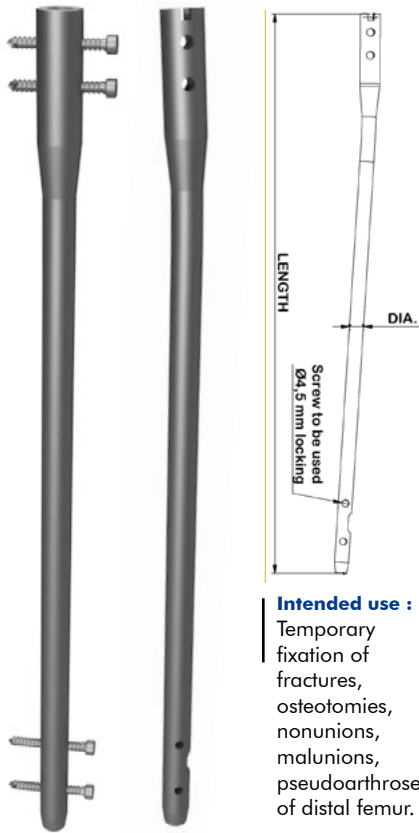

Intended use :

Temporary fixation of fractures, osteotomies, nonunions, malunions, pseudoarthroses of distal femur.

SS	TI	DIA. x LENGTH (mm)
A4499200	A4489200	9X200
A4499220	A4489220	9X220
A4499240	A4489240	9X240
A4499260	A4489260	9X260
A4490200	A4480200	10X200
A4490220	A4480220	10X220
A4490240	A4480240	10X240
A4490260	A4480260	10X260
A4491200	A4481200	11X200
A4491220	A4481220	11X220
A4491240	A4481240	11X240
A4491260	A4481260	11X260
A4490300	A4480300	12X200
A4490320	A4480320	12X220
A4490340	A4480340	12X240
A4490360	A4480360	12X260
A4491300	A4481300	13X200
A4491320	A4481320	13X220
A4491340	A4481340	13X240
A4491360	A4481360	13X260

4,5 mm Intramedullary Nail Locking Screw

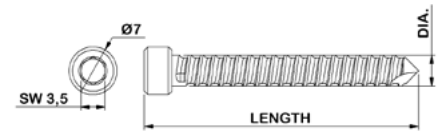

SS	TI	DIA. X LENGTH (mm)
A4194020	A4184020	4,5X20
A4194025	A4184025	4,5X25
A4194030	A4184030	4,5X30
A4194035	A4184035	4,5X35
A4194040	A4184040	4,5X40
A4194045	A4184045	4,5X45
A4194050	A4184050	4,5X50
A4194055	A4184055	4,5X55
A4194060	A4184060	4,5X60
A4194065	A4184065	4,5X65
A4194070	A4184070	4,5X70
A4194075	A4184075	4,5X75

Femur Short Reconstruction Intramedullary Nail (PFN)

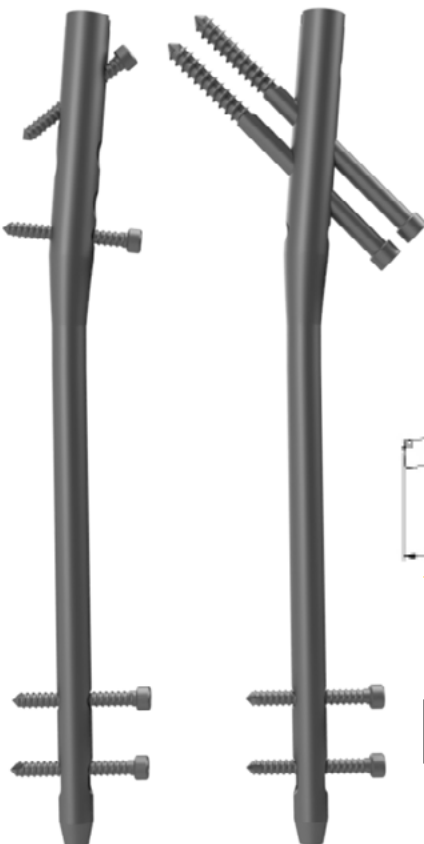

TI	DIA. x LENGTH (mm)
A4289240	9X240
A4280240	10X240
A4281240	11X240
A3282240	12X240

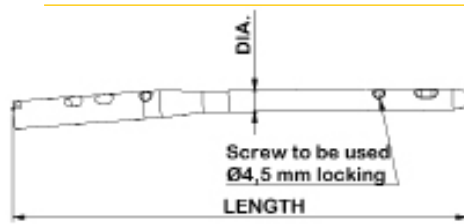

Intended use : Temporary fixation of fractures, osteotomies, nonunions, malunions, pseudoarthroses of proximal femur. Especially used in ipsilateral pertrochanteric, intertrochanteric, subtrochanteric, femoral neck fractures.

Distal Femur Intramedullary Nail (DFN / RETROGRADE) End Cap



SS	TI
A100 03 040 4700	A100 03 040 4800

Intramedullary Nails/Femur

Femur Long Reconstruction Intramedullary Nail

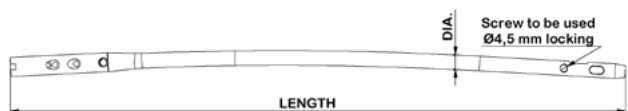
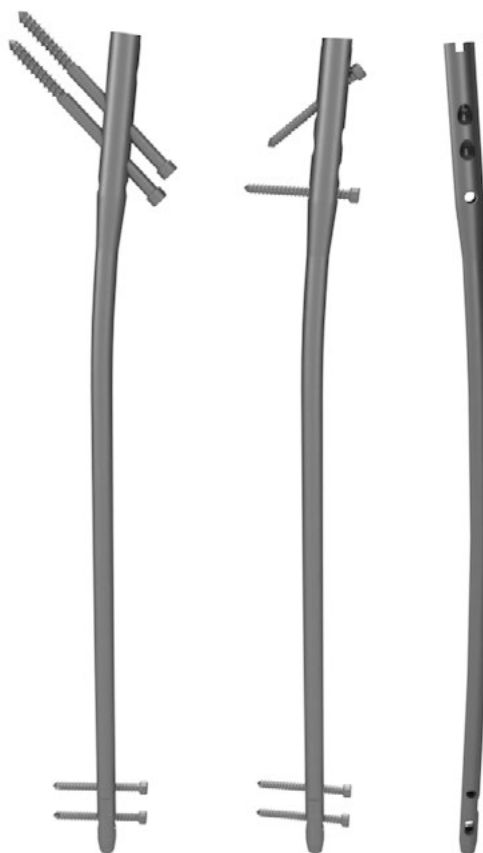

TI	DIA. x LENGTH (mm)	SIDE	TI	DIA. x LENGTH (mm)	SIDE
A4389340	9X340	Left	A4399340	9X340	Right
A4389360	9X360	Left	A4399360	9X360	Right
A4389380	9X380	Left	A4399380	9X380	Right
A4389400	9X400	Left	A4399400	9X400	Right
A4389420	9X420	Left	A4399420	9X420	Right
A4380340	10X340	Left	A4390340	10X340	Right
A4380360	10X360	Left	A4390360	10X360	Right
A4380380	10X380	Left	A4390380	10X380	Right
A4380400	10X400	Left	A4390400	10X400	Right
A4380420	10X420	Left	A4390420	10X420	Right
A4381340	11X340	Left	A4391340	11X340	Right
A4381360	11X360	Left	A4391360	11X360	Right
A4381380	11X380	Left	A4391380	11X380	Right
A4381400	11X400	Left	A4391400	11X400	Right
A4381420	11X420	Left	A4391420	11X420	Right
A4382340	12X340	Left	A4392340	12X340	Right
A4382360	12X360	Left	A4392360	12X360	Right
A4382380	12X380	Left	A4392380	12X380	Right
A4382400	12X400	Left	A4392400	12X400	Right
A4382420	12X420	Left	A4392420	12X420	Right
A4383340	13X340	Left	A4393340	13X340	Right
A4383360	13X360	Left	A4393360	13X360	Right
A4383380	13X380	Left	A4393380	13X380	Right
A4383400	13X400	Left	A4393400	13X400	Right
A4383420	13X420	Left	A4393420	13X420	Right

Intended use : Temporary fixation of fractures, osteotomies, nonunions, malunions, pseudoarthroses of proximal femur. Especially used in ipsilateral pertrochanteric, intertrochanteric, subtrochanteric, femoral neck fractures and femoral shaft fractures.

Femur Long Reconstruction Intramedullary Nail Lag Screw



TI	DIA. x LENGTH (mm)	TI	DIA. x LENGTH (mm)
A4385065	6,4X65	A4385095	6,4X95
A4385070	6,4X70	A4385100	6,4X100
A4385075	6,4X75	A4385105	6,4X105
A4385080	6,4X80	A4385110	6,4X110
A4385085	6,4X85	A4385115	6,4X115
A4385090	6,4X90	A4385120	6,4X120



Intramedullary Nails/Femur

4,5 mm Intramedullary Nail Locking Screw

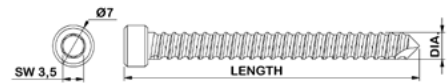

TI	DIA. x LENGTH (mm)
A4184020	4,5X20
A4184025	4,5X25
A4184030	4,5X30
A4184035	4,5X35
A4184040	4,5X40
A4184045	4,5X45
A4184050	4,5X50
A4184055	4,5X55
A4184060	4,5X60
A4184065	4,5X65
A4184070	4,5X70
A4184075	4,5X75

Femur Long Reconstruction Intramedullary Nail End Cap

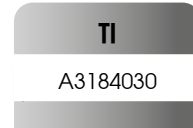

APFNA Femur Short Intramedullary Nail

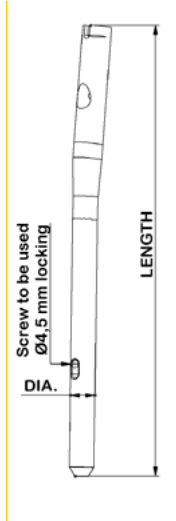

TI	DIA. x LENGTH (mm)
A3080320	9X180
A3080340	9X200
A3080360	9X240
A3080380	10X180
A3080400	10X200
A3080420	10X240
A3080440	11X180
A3080460	11X200
A3081320	11X240
A3081340	12X180
A3081360	12X200
A3081380	12X240
A3081400	13X180
A3081420	13X200
A3081440	13X240
A3081460	14X180
A3082320	14X200
A3082340	14X240

Intended use : Temporary fixation of fractures, osteotomies, nonunions, malunions, pseudoarthroses of proximal femur. Especially used in pertrochanteric, intertrochanteric, subtrochanteric, femoral neck fractures

Intramedullary Nails/Femur

APFNA Intramedullary Nail End Cap

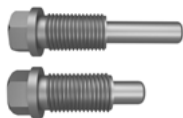

TI	DIA. x LENGTH (mm)
A3184020	26
A3184025	40

APFNA Intramedullary Nail Blade Screw



TI	DIA. x LENGTH (mm)
A3395075	10,4X75
A3395080	10,4X80
A3395085	10,4X85
A3395090	10,4 X90
A3395095	10,4X95
A3395100	10,4X100
A3395105	10,4X105
A3395110	10,4X110
A3395115	10,4X115
A3395120	10,4X120

AROCOM Proximal Femur Anti-Rotation Compression Intramedullary Nail

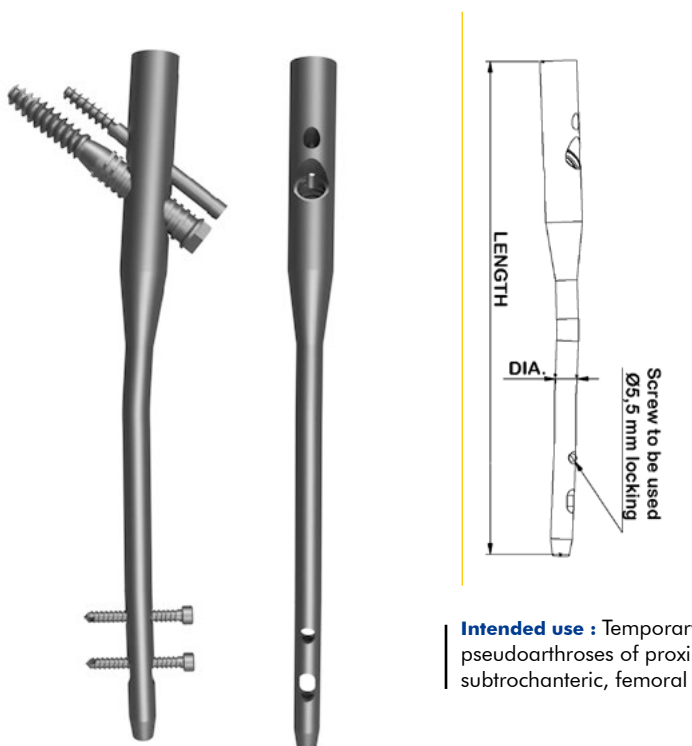

TI	DIA. x LENGTH (mm)
A3089320	10X220
A3089340	11X220
A3089360	12X220
A3089380	13X220

Intended use : Temporary fixation of fractures, osteotomies, nonunions, malunions, pseudoarthroses of proximal femur. Especially used in pertrochanteric, intertrochanteric, subtrochanteric, femoral neck fractures.

AROCOM Proximal Femur Anti-Rotation Intramedullary Nail End Cap

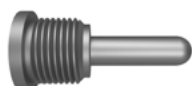

TI
A3184035



TI	LENGTH
A3184040	35

Intramedullary Nails/Femur

AROCOM Proximal Femur Anti-Rotation Intramedullary Nail Lag Screw



TI	DIA x LENGTH (mm)	TI	DIA. x LENGTH (mm)
A3082360	10X75	A3083320	10X105
A3082380	10X80	A3083340	10X110
A3082400	10X85	A3083360	10X115
A3082420	10X90	A3083380	10X120
A3082440	10X95	A3083400	10X125
A3082460	10X100	A3083420	10X130

AROCOM Proximal Femur Anti-Rotation Intramedullary Nail Anti-Rotation Screw



TI	DIA x LENGTH (mm)	TI	DIA. x LENGTH (mm)
A3083460	6X65	A3084440	6X100
A3084320	6X70	A3084460	6X105
A3084340	6X75	A3085320	6X110
A3084360	6X80	A3085340	6X115
A3084380	6X85	A3085360	6X120
A3084400	6X90	A3085380	6X125
A3084420	6X95	A3085400	6X130

AROCOM Proximal Femur Anti-Rotation Intramedullary Nail Connection Sleeve



TI	DIA. x LENGTH (mm)
A3083440	12X52

AROCOM Proximal Femur Anti-Rotation Intramedullary Nail Locking Screw



TI	DIA. x LENGTH (mm)	TI	DIA. x LENGTH (mm)
A3085420	5.5X26	A3086400	5,5X40
A3085440	5.5X28	A3086420	5.5X42
A3085460	5.5X30	A3086440	5.5X44
A3086320	5.5X32	A3086460	5.5X46
A3086340	5.5X34	A4283240	5.5X48
A3086360	5.5X36	A4284240	5.5X50
A3086380	5.5X38		

Intramedullary Nails/Femur

ANTIRO Proximal Femur Anti-Rotation Intramedullary Nail



TI	DIA. x LENGTH (mm)
A3089400	10X220
A3089420	11X220
A3089440	12X220
A3089460	13X220

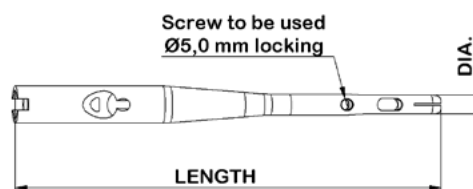

Intended use : Temporary fixation of fractures, osteotomies, nonunions, malunions, pseudoarthroses of proximal femur. Especially used in pertrochanteric, intertrochanteric, subtrochanteric, femoral neck fractures.

ANTIRO Proximal Femur Anti-Rotation Intramedullary Nail End Cap



TI
A3184045

ANTIRO Proximal Femur Anti-Rotation Intramedullary Nail Compression Screw



TI
A3184050

ANTIRO Proximal Femur Anti-Rotation Intramedullary Nail Lag Screw



TI	DIA. x LENGTH (mm)
A4384320	11,5X75
A4384340	11,5X80
A4384360	11,5X85
A4384380	11,5X90
A4384400	11,5X95
A4384420	11,5X100
A4384440	11,5X105
A4384460	11,5X110
A4385320	11,5X115
A4385340	11,5X120

Intramedullary Nails/Femur

ANTIRO Proximal Femur Anti-Rotation Intramedullary Nail Pin



TI	DIA. x LENGTH (mm)	TI	DIA. x LENGTH (mm)
A4385360	5X75	A4385460	5X100
A4385380	5X80	A4386320	5X105
A4385400	5X85	A4386340	5X110
A4385420	5X90	A4386360	5X115
A4385440	5X95	A4386380	5X120

ANTIRO Proximal Femur Anti-Rotation Intramedullary Nail Locking Screw



TI	DIA. x LENGTH (mm)	TI	DIA. x LENGTH (mm)
A43879320	5X20	A43879440	5X50
A43879340	5X25	A43879460	5X55
A43879360	5X30	A43870320	5X60
A43879380	5X35	A43870340	5X65
A43879400	5X40	A43870360	5X70
A43879420	5X45	A43870380	5X75



Intramedullary Nails/Tibia

Tibia Intramedullary Nail

SS	TI	DIA. x LENGTH (mm)	SS	TI	DIA. x LENGTH (mm)
A4199260	A4189260	8X255	A4192260	A4182260	11X255
A4199280	A4189280	8X270	A4192280	A4182280	11X270
A4199300	A4189300	8X285	A4192300	A4182300	11X285
A4199320	A4189320	8X300	A4192320	A4182320	11X300
A4199340	A4189340	8X315	A4192340	A4182340	11X315
A4199360	A4189360	8X330	A4192360	A4182360	11X330
A4199380	A4189380	8X345	A4192380	A4182380	11X345
A4199400	A4189400	8X360	A4192400	A4182400	11X360
A3199340	A3189340	8X375	A3192340	A3182340	11X375
A3199360	A3189360	8X390	A3192360	A3182360	11X390
A3199380	A3189380	8X405	A3192380	A3182380	11X405
A3199400	A3189400	8X420	A3192400	A3182400	11X420
A4190260	A4180260	9X255	A4193260	A4183260	12X255
A4190280	A4180280	9X270	A4193280	A4183280	12X270
A4190300	A4180300	9X285	A4193300	A4183300	12X285
A4190320	A4180320	9X300	A4193320	A4183320	12X300
A4190340	A4180340	9X315	A4193340	A4183340	12X315
A4190360	A4180360	9X330	A4193360	A4183360	12X330
A4190380	A4180380	9X345	A4193380	A4183380	12X345
A4190400	A4180400	9X360	A4193400	A4183400	12X360
A3190340	A3180340	9X375	A3193340	A3183340	12X375
A3190360	A3180360	9X390	A3193360	A3183360	12X390
A3190380	A3180380	9X405	A3193380	A3183380	12X405
A3190400	A3180400	9X420	A3193400	A3183400	12X420
A4191260	A4181260	10X255	A4194260	A4184260	13X255
A4191280	A4181280	10X270	A4194280	A4184280	13X270
A4191300	A4181300	10X285	A4194300	A4184300	13X285
A4191320	A4181320	10X300	A4194320	A4184320	13X300
A4191340	A4181340	10X315	A4194340	A4184340	13X315
A4191360	A4181360	10X330	A4194360	A4184360	13X330
A4191380	A4181380	10X345	A4194380	A4184380	13X345
A4191400	A4181400	10X360	A4194400	A4184400	13X360
A3191340	A3181340	10X375	A3194340	A3184340	13X375
A3191360	A3181360	10X390	A3194360	A3184360	13X390
A3191380	A3181380	10X405	A3194380	A3184380	13X405
A3191400	A3181400	10X420	A3194400	A3184400	13X420

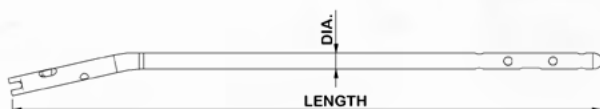
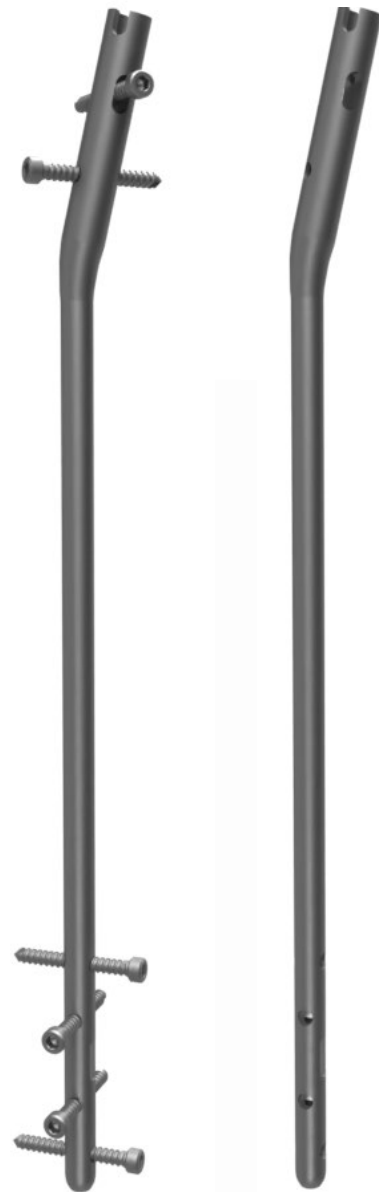

Intended use : Temporary fixation of fractures, osteotomies, nonunions, malunions, pseudoarthroses of tibia. Especially used for tibia shaft fractures.

Intramedullary Nails/Tibia

ANT Tibia Intramedullary Nail

TI	DIA. x LENGTH (mm)	TI	DIA. x LENGTH (mm)
A100 03 037 2708	8X270	A100 03 037 2709	9X270
A100 03 037 2808	8X285	A100 03 037 2809	9X285
A100 03 037 3008	8X300	A100 03 037 3009	9X300
A100 03 037 3108	8X315	A100 03 037 3109	9X315
A100 03 037 3308	8X330	A100 03 037 3309	9X330
A100 03 037 3408	8X345	A100 03 037 3409	9X345
A100 03 037 3608	8X360	A100 03 037 3609	9X360
A100 03 037 3808	8X375	A100 03 037 3809	9X375
A100 03 037 4008	8X390	A100 03 037 4009	9X390
A100 03 037 4208	8X405	A100 03 037 4209	9X405
A100 03 037 2710	10X270	A100 03 037 4409	9X420
A100 03 037 2810	10X285	A100 03 037 2711	11X270
A100 03 037 3010	10X300	A100 03 037 2811	11X285
A100 03 037 3110	10X315	A100 03 037 3011	11X300
A100 03 037 3310	10X330	A100 03 037 3111	11X315
A100 03 037 3410	10X345	A100 03 037 3311	11X330
A100 03 037 3610	10X360	A100 03 037 3411	11X345
A100 03 037 3810	10X375	A100 03 037 3611	11X360
A100 03 037 4010	10X390	A100 03 037 3811	11X375
A100 03 037 4210	10X405	A100 03 037 4011	11X390
A100 03 037 4410	10X420	A100 03 037 4211	11X405
A100 03 037 2712	12X270	A100 03 037 4411	11X420
A100 03 037 2812	12X285	A100 03 037 2813	13X285
A100 03 037 3012	12X300	A100 03 037 3013	13X300
A100 03 037 3112	12X315	A100 03 037 3113	13X315
A100 03 037 3312	12X330	A100 03 037 3313	13X330
A100 03 037 3412	12X345	A100 03 037 3413	13X345
A100 03 037 3612	12X360	A100 03 037 3613	13X360
A100 03 037 3812	12X375	A100 03 037 3813	13X375
A100 03 037 4012	12X390	A100 03 037 4013	13X390
A100 03 037 4212	12X405	A100 03 037 4213	13X405
A100 03 037 4412	12X420	A100 03 037 4413	13X420

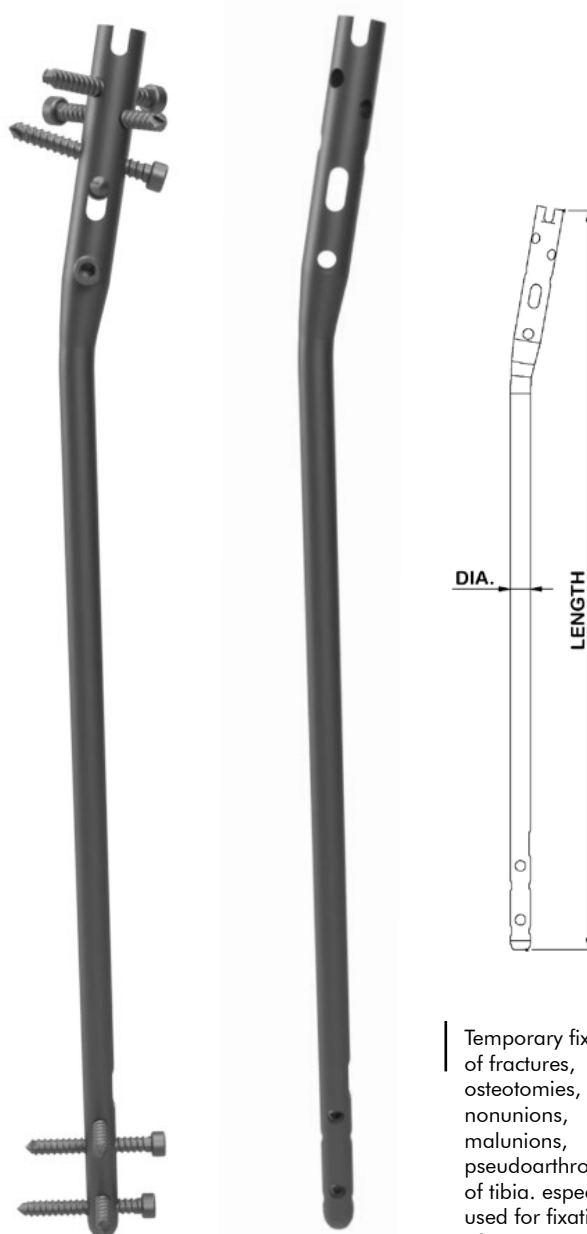

Temporary fixation of fractures, osteotomies, nonunions, malunions, pseudoarthroses of tibia. especially used for fixation of ipsilateral tibia plateau and shaft fractures.

4,5 mm Intramedullary Nail Locking Screw



TI	DIA x LENGTH (mm)	TI	DIA x LENGTH (mm)
A4184020	4,5X20	A4184050	4,5X50
A4184025	4,5X25	A4184055	4,5X55
A4184030	4,5X30	A4184060	4,5X60
A4184035	4,5X35	A4184065	4,5X65
A4184040	4,5X40	A4184070	4,5X70
A4184045	4,5X45	A4184075	4,5X75

ANT Tibia Intramedullary Nail End Cap



TI
A100 03 040 4600

"We supply WORLD's
Orthopedic & Trauma
Implants..."

Elastic Nails



Elastic Nails

Elastic Nail

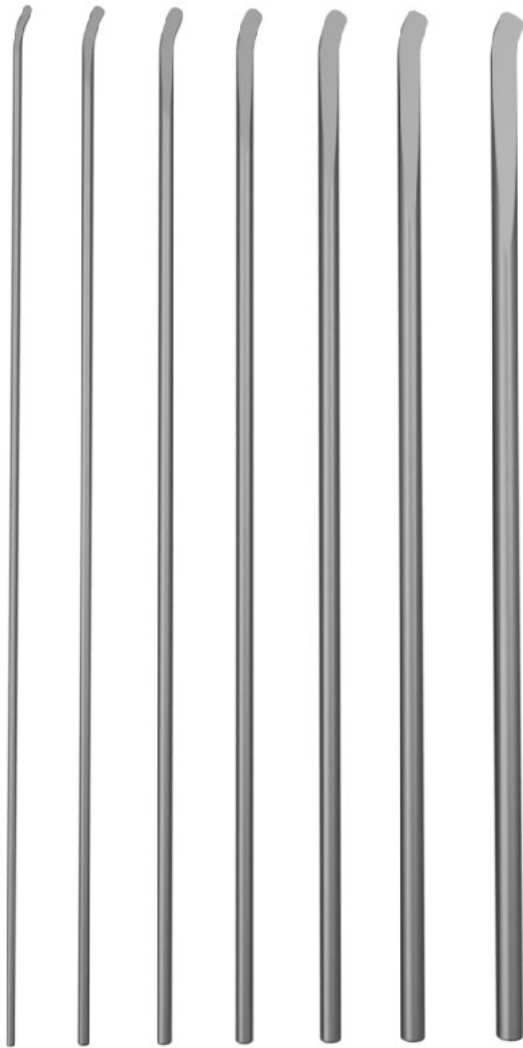

TI	DIAMETER (mm)	LENGTH (mm)
A45015440	1,5	440
A45020440	2,0	440
A45025440	2,5	440
A45030440	3,0	440
A45035440	3,5	440
A45040440	4,0	440
A45045440	4,5	440
A45050440	5,0	440
A45055440	5,5	440

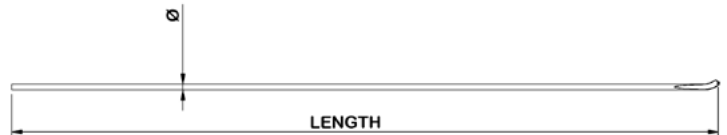

Intended use : Temporary fixation of fractures, osteotomies, malunions, nonunions, pseduarthroses of long bones (humerus, ulna, radius, femur, tibia, fibula). Especially used in pediatric and adolescent patients.

Elastic Nail End Cap

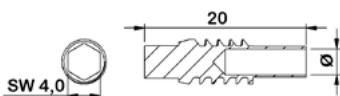

TI	DIAMETER (mm)
A45015	1,5
A45020	2,0
A45025	2,5
A45030	3,0
A45035	3,5
A45040	4,0
A45045	4,5
A45050	5,0
A45055	5,5

"We supply WORLD's
Orthopedic & Trauma
Implants..."

Spinal Systems



Asino Fixed Angle Screw



Intended use : Temporary fixation of fractures, pseudoarthrosis, spondylolisthesis of vertebrae.

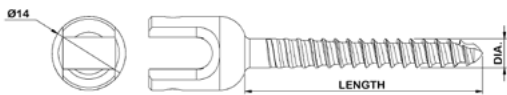

TI	DIA x LENGTH (mm)
A8124025	4,0X25
A8124030	4,0X30
A8124035	4,0X35
A8124040	4,0X40
A8124525	4,5X25
A8124530	4,5X30
A8124535	4,5X35
A8124540	4,5X40
A8124545	4,5X45
A8125030	5,0X30
A8125035	5,0X35
A8125040	5,0X40
A8125045	5,0X45
A8125050	5,0X50
A8125530	5,5X30
A8125535	5,5X35
A8125540	5,5X40
A8125545	5,5X45
A8125550	5,5X50
A8126030	6,0X30
A8126035	6,0X35
A8126040	6,0X40
A8126045	6,0X45
A8126050	6,0X50
A8126055	6,0X55

TI	DIA x LENGTH (mm)
A8126530	6,5X30
A8126535	6,5X35
A8126540	6,5X40
A8126545	6,5X45
A8126550	6,5X50
A8126555	6,5X55
A8126560	6,5X60
A8126565	6,5X65
A8127030	7,0X30
A8127035	7,0X35
A8127040	7,0X40
A8127045	7,0X45
A8127050	7,0X50
A8127055	7,0X55
A8127060	7,0X60
A8127065	7,0X65
A8127530	7,5X30
A8127535	7,5X35
A8127540	7,5X40
A8127545	7,5X45
A8127550	7,5X50
A8127555	7,5X55
A8127560	7,5X60
A8127565	7,5X65mm

Asino Fixed-Angle Reduction Screw



Intended use : Temporary fixation of fractures, pseudoarthrosis, spondylolisthesis of vertebrae. Especially used for reduction of displaced vertebrae.



TI	DIA x LENGTH (mm)
A8164025	4,0X25
A8164030	4,0X30
A8164035	4,0X35
A8164040	4,0X40
A8164530	4,5X30
A8164535	4,5X35
A8164540	4,5X40
A8164545	4,5X45
A8165030	5,0X30
A8165035	5,0X35
A8165040	5,0X40
A8165045	5,0X45
A8165530	5,5X30
A8165535	5,5X35
A8165540	5,5X40
A8165545	5,5X45
A8165550	5,5X50

TI	DIA x LENGTH (mm)
A8166030	6,0X30
A8166035	6,0X35
A8166040	6,0X40
A8166045	6,0X45
A8166050	6,0X50
A8166530	6,5X30
A8166535	6,5X35
A8166540	6,5X40
A8166545	6,5X45
A8166550	6,5X50
A8166555	6,5X55
A8167030	7,0X30
A8167035	7,0X35
A8167040	7,0X40
A8167045	7,0X45
A8167050	7,0X50

Asino Multi-Axial Screw

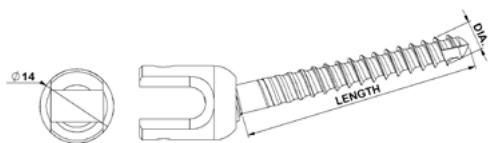

Intended use : Temporary fixation of fractures, pseudoarthrosis, spondylolisthesis of vertebrae.

TI	DIA x LENGTH (mm)
A8104025	4,0X25
A8104030	4,0X30
A8104035	4,0X35
A8104040	4,0X40
A8104530	4,5X30
A8104535	4,5X35
A8104540	4,5X40
A8104545	4,5X45
A8105030	5,0X30
A8105035	5,0X35
A8105040	5,0X40
A8105045	5,0X45
A8105530	5,5X30
A8105535	5,5X35
A8105540	5,5X40
A8105545	5,5X45
A8105550	5,5X50
A8106030	6,0X30
A8106035	6,0X35
A8106040	6,0X40
A8106045	6,0X45
A8106050	6,0X50
A8106055	6,0X55

TI	DIA x LENGTH (mm)
A8106530	6,5X30
A8106535	6,5X35
A8106540	6,5X40
A8106545	6,5X45
A8106550	6,5X50
A8106555	6,5X55
A8107030	7,0X30
A8107035	7,0X35
A8107040	7,0X40
A8107045	7,0X45
A8107050	7,0X50
A8107530	7,5X30
A8107535	7,5X35
A8107540	7,5X40
A8107545	7,5X45
A8107550	7,5X50
A8107555	7,5X55
A8107560	7,5X60
A8107565	7,5X65

Asino Multi-Axial Reduction Screw

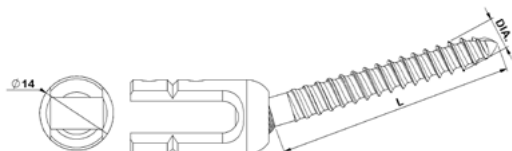

Intended use : Temporary fixation of fractures, pseudoarthrosis, spondylolisthesis of vertebrae. especially used for reduction of displaced vertebrae.

TI	DIA x LENGTH (mm)
A8144025	4,0X25
A8144030	4,0X30
A8144035	4,0X35
A8144040	4,0X40
A8144530	4,5X30
A8144535	4,5X35
A8144540	4,5X40
A8144545	4,5X45
A8145030	5,0X30
A8145035	5,0X35
A8145040	5,0X40
A8145045	5,0X45
A8145050	5,0X50
A8145530	5,5X30
A8145535	5,5X35
A8145540	5,5X40
A8145545	5,5X45

TI	DIA x LENGTH (mm)
A8146030	6,0X30
A8146035	6,0X35
A8146040	6,0X40
A8146045	6,0X45
A8146050	6,0X50
A8146530	6,5X30
A8146535	6,5X35
A8146540	6,5X40
A8146545	6,5X45
A8146550	6,5X50
A8147035	7,0X35
A8147040	7,0X40
A8147045	7,0X45

Asino Cross Link Plate



TI	DIA x LENGTH (mm)
A8482001	6,0X28
A8482002	6,0X48
A8482003	6,0X68
A8482004	6,0X88

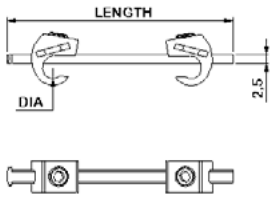

Intended use : Temporary fixation of fractures, pseudoarthrosis, spondylolisthesis of vertebrae. Used for purpose of cross linking of two rods.

6,0 mm Hook



TI	TYPE
A8460001	Pedicle Hook
A8460002	Laminar Hook
A8460003	Transverse Process Hook

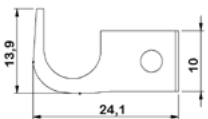

Intended use : Temporary fixation of fractures, pseudoarthrosis, spondylolisthesis of vertebrae.

Set Screw



TI
A8420600

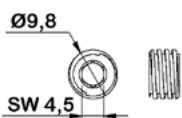

Lateral Connector 6,0 mm



TI
A8426006

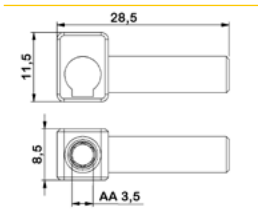

Connector 6,0 mm



TI
A8440810

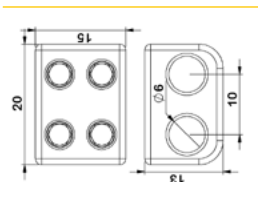

Rod 6,0 mm

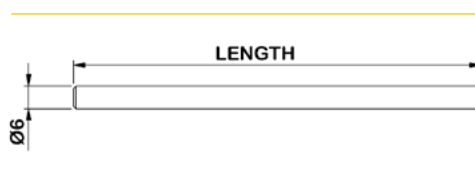
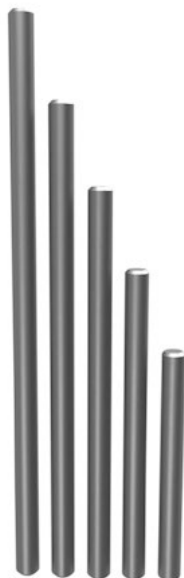

TI	DIA x LENGTH (mm)
A8001030	6,0X30
A8001035	6,0X35
A8001040	6,0X40
A8001050	6,0X50
A8001060	6,0X60
A8001070	6,0X70
A8001080	6,0X80
A8001090	6,0X90
A8001100	6,0X100
A8001110	6,0X110
A8001250	6,0X250
A8001500	6,0X500

Pediatric Rod 5,0 mm

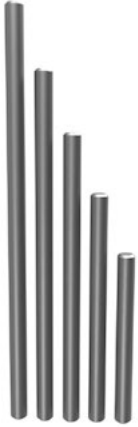

TI	DIA x LENGTH (mm)
A425 20 060 0060	5,0X60
A425 20 060 0080	5,0X80
A425 20 060 0100	5,0X100
A425 20 060 0110	5,0X110
A425 20 060 0120	5,0X120
A425 20 060 0130	5,0X130
A425 20 060 0140	5,0X140
A425 20 060 0150	5,0X150
A425 20 060 0160	5,0X160
A425 20 060 0180	5,0X180

TI	DIA x LENGTH (mm)
A425 20 060 0200	5,0X200
A425 20 060 0240	5,0X240
A425 20 060 0260	5,0X260
A425 20 060 0280	5,0X280
A425 20 060 0300	5,0X300
A425 20 060 0320	5,0X320
A425 20 060 0340	5,0X340
A425 20 060 0360	5,0X360
A425 20 060 0380	5,0X380

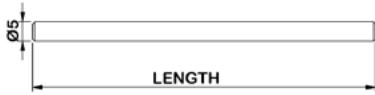

Anterior Cervical Plate 1

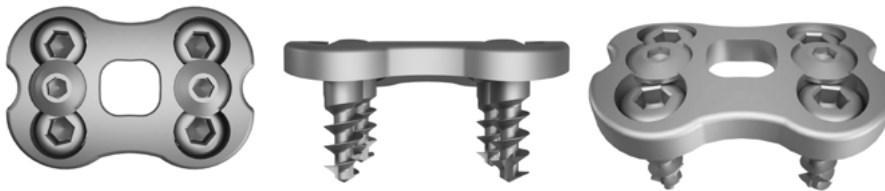

TI	LENGTH (mm)
A433 02 011 0020	26
A433 02 011 0030	30
A433 02 011 0040	33
A433 02 011 0050	36
A433 02 011 0060	39
A433 02 011 0070	42
A433 02 011 0080	45
A433 02 013 0020	48
A433 02 013 0030	51
A433 02 013 0040	54
A433 02 013 0050	57
A433 02 013 0060	61
A433 02 013 0070	64
A433 02 013 0080	70

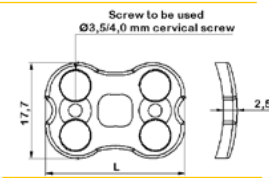

Intended use : Temporary fixation of fractures, pseudoarthrosis, spondylolisthesis, fusion of cervical vertebrae.

Anterior Cervical Screw-Plate Locking Apparatus



TI
A442 00 000 0001

Cervical Screw



TI	DIA x LENGTH (mm)
A6133528	3,5X12
A6133530	3,5X14
A6133532	3,5X16
A6133534	3,5X18
A6133536	3,5X20

Anterior Cervical Plate 2

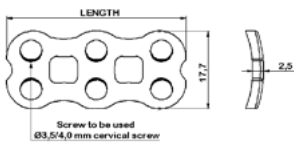

Intended use : Temporary fixation of fractures, pseudoarthrosis, spondylolisthesis, fusion of cervical vertebrae.

TI	LENGTH (mm)
A433 02 015 0020	25
A433 02 015 0030	27,5
A433 02 015 0040	30
A433 02 015 0050	32,5
A433 02 015 0060	35
A433 02 015 0070	37,5
A433 02 015 0080	40
A438 02 002 0070	45
A438 02 002 0075	50
A438 02 002 0080	55
A438 02 002 0085	60
A438 02 002 0090	65
A438 02 002 0095	70
A438 02 002 0100	75

Cervical Expansion Head Locking Screw

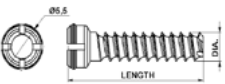

Cervical Screw Head Expansion Aparatus



TI	DIA x LENGTH (mm)
A400 02 051 0030	4,0X13
A400 02 051 0034	4,0X14
A400 02 051 0036	4,0X15
A400 02 051 0040	4,0X16
A400 02 051 0044	4,0X17
A400 02 052 0025	4,0X18

Anterior Thoracic and Lumbar Plate



TI	LENGTH (mm)
A400 02 440 0040	60
A400 02 440 0050	65
A400 02 440 0060	70
A400 02 440 0070	75
A400 02 440 0080	80
A400 02 440 0090	85
A400 02 440 0100	90
A400 02 440 0110	100

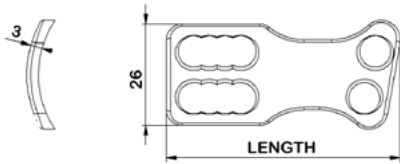

Intended use : Temporary fixation of fractures, pseudoarthrosis, spondylolisthesis, fusion of thoracic and lumbar vertebrae.

Anterior Thoracic and Lumbar Bolt



TI	DIA x LENGTH (mm)
A6134510	6,5X30
A6134512	6,5X35
A6134514	6,5X40
A6134516	6,5X45
A6134518	6,5X50

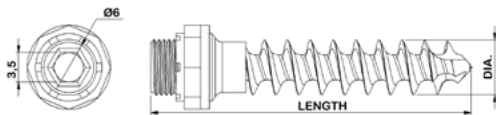

Anterior Thoracic and Lumbar Screw



TI	DIA x LENGTH (mm)
A6144014	6,5X30
A6144016	6,5X35
A6144018	6,5X40
A6144020	6,5X45
A6144022	6,5X50

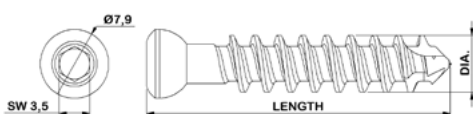

"We supply WORLD's
Orthopedic & Trauma
Implants..."

External Fixators



Ayfix Dynamic Axial External Fixators

Ayfix Dynamic Axial External Fixator Femur-Tibia



Half-Pin (Schanz Screw) to be used
Ø (5,0/5,5/6,0 mm)

Allen Wrench to be used
Ø (6,0 mm)

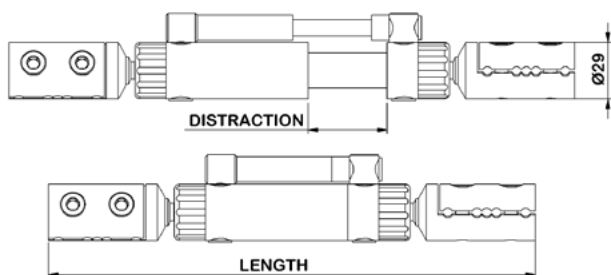

CAT. NO	TYPE	DISTRACTION (mm)	LENGTH (mm)
A600 11 100 0001	Long	60	270
A600 11 100 0002	Medium	40	250
A600 11 100 0003	Short	20	230

Intended use : Temporary fixation of fractures, nonunions, malunions, osteotomies, pseduarthrosis, of femur and tibia, arthrodesis of hip, knee, ankle joints. Especially used for fixation of open fractures of femur, tibia and for distraction and compression purposes on fracture site.

| available as aluminium/stainless steel/peek.

Ayfix Dynamic Axial External Fixator Femur-Tibia T-Clamp

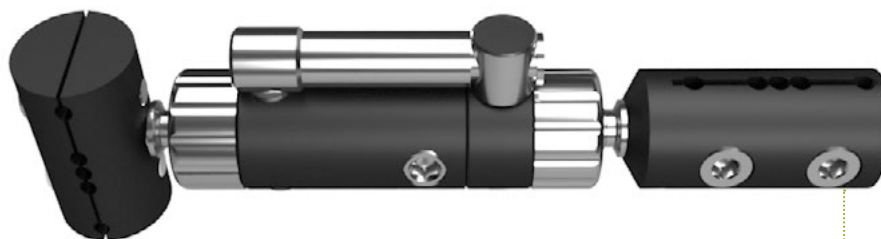

Half-Pin (Schanz Screw) to be used
Ø (5,0/5,5/6,0 mm)

Allen Wrench to be used
Ø (6,0 mm)

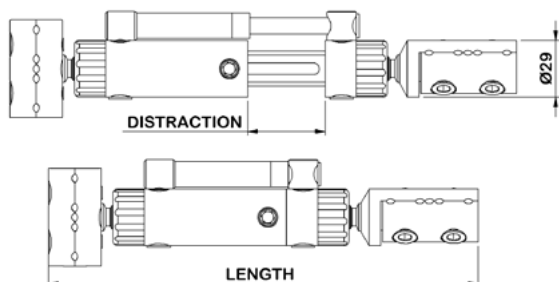

CAT. NO	TYPE	DISTRACTION (mm)	LENGTH (mm)
A600 16 100 0006	Long	60	240
A600 16 100 0007	Medium	40	220
A600 16 100 0008	Short	20	200

Intended use : Temporary fixation of fractures, nonunions, malunions, osteotomies, pseduarthrosis, of femur and tibia, arthrodesis of hip, knee, ankle joints. Especially used for fixation of open fractures of proximal and distal femur-tibia and for distraction and compression purposes on fracture site.

| available as aluminium/stainless steel/peek.

Ayfix Dynamic Axial External Fixators

Ayfix Dynamic Axial External Fixator Trochanteric Clamp (135°)



Half-Pin (Schanz Screw) to be used
Ø (5,0/5,5/6,0 mm)

Allen Wrench to be used
Ø (6,0 mm)

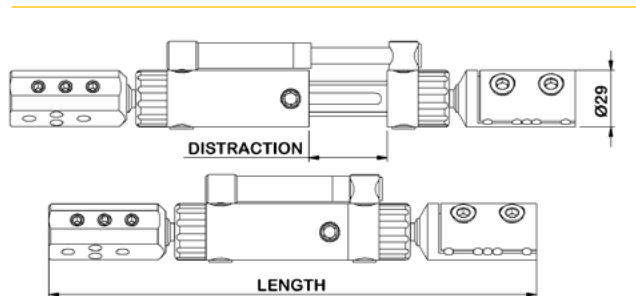

CAT. NO	TYPE	DISTRACTION (mm)	LENGTH (mm)
A600 11 100 0040	Long	60	270
A600 11 100 0041	Medium	40	250
A600 11 100 0042	Short	20	230

Intended use : Temporary fixation of fractures, nonunions, malunions, osteotomies, pseduarthrosis, of femur. Especially used for fixation of fractures of proximal femur (intertrochanteric, pertrochanteric) in elderly patients for early mobilization, for distraction and compression purposes on fracture site.

| available as aluminium/stainless steel/peek.

Ayfix Dynamic Axial External Fixator Square Clamp Femur-Tibia



Half-Pin (Schanz Screw) to be used
Ø (5,0/5,5/6,0 mm)

Allen Wrench to be used
Ø (6,0 mm)

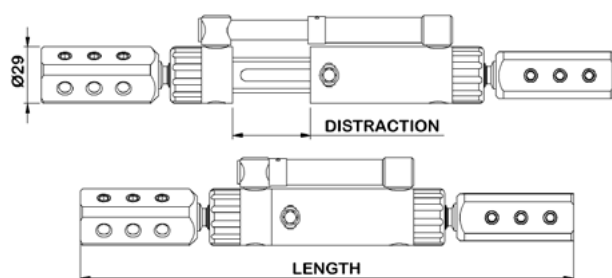

CAT. NO	TYPE	DISTRACTION (mm)	LENGTH (mm)
A600 11 100 0140	Long	60	270
A600 11 100 0141	Medium	40	250
A600 11 100 0142	Short	20	230

Intended use : Temporary fixation of fractures, nonunions, malunions, osteotomies, pseduarthrosis, of femur and tibia, arthrodesis of hip, knee, ankle joints. Especially used for fixation of open fractures of femur, tibia and for distraction and compression purposes on fracture site.

| available as aluminium/stainless steel/peek.

Ayfix Dynamic Axial External Fixators

Ayfix Limb Lengthening External Fixator Femur-Tibia



Half-Pin (Schanz Screw) to be used
 Ø (5,0/5,5/6,0 mm)

Allen Wrench to be used
 Ø (6,0 mm)

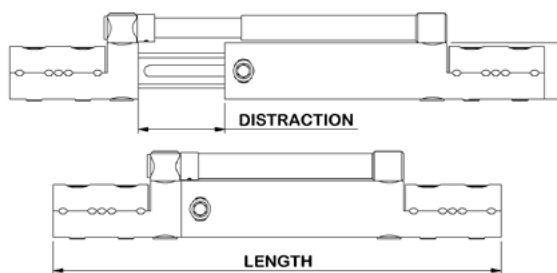

CAT. NO	TYPE	DISTRACTION (mm)	LENGTH (mm)
A600 11 100 0020	Long	97	250
A600 11 100 0021	Medium	77	230
A600 11 100 0022	Short	57	210

Intended use : Temporary fixation of fractures, nonunions, malunions, osteotomies, pseduarthrosis, of femur and tibia, arthrodesis of hip knee ankle joints. Especially used for fixation of open fractures of femur, tibia and for distraction and compression purposes on fracture site also used for lengthening purposes of femur and tibia bones.

| available as aluminium/stainless steel/peek.

Ayfix Dynamic Axial Ankle Fixator



Half-Pin (Schanz Screw) to be used
 Ø (5,0/5,5/6,0 mm)

Allen Wrench to be used
 Ø (6,0 mm)

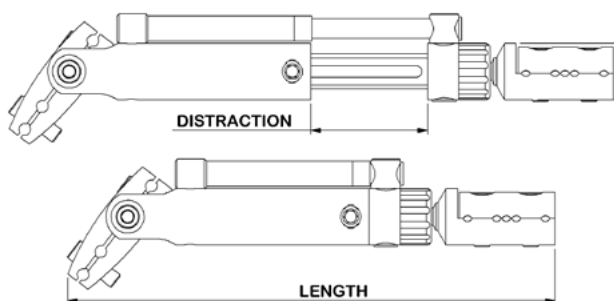

CAT. NO	TYPE	DISTRACTION (mm)	LENGTH (mm)
A600 11 100 0004	Left - Long	80	275
A600 11 100 0005	Left - Medium	60	255
A600 11 100 0006	Left - Short	40	235
A600 11 101 0004	Right - Long	80	275
A600 11 101 0005	Right - Medium	60	255
A600 11 101 0006	Right - Short	40	235

Intended use : Temporary fixation of fractures, nonunions, malunions, osteotomies, pseduarthrosis, of distal tibia, arthrodesis of ankle joints. Especially used for fixation of open fractures of distal tibia and for distraction and compression purposes on fracture site.

| available as aluminium/stainless steel/peek.

Ayfix Dynamic Axial External Fixators

Ayfix Dynamic Axial External Fixator Humerus



Allen Wrench to be used
Ø (5,0 mm)

Half-Pin (Schanz Screw) to be used
Ø (4,0/4,5/5,0 mm)

CAT. NO	TYPE	DISTRACTION (mm)	LENGTH (mm)
A600 16 100 0001	Long	51	235
A600 16 100 0002	Medium	31	215
A600 16 100 0003	Short	11	195

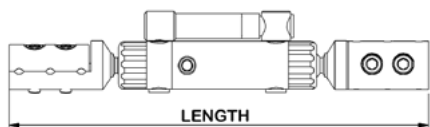
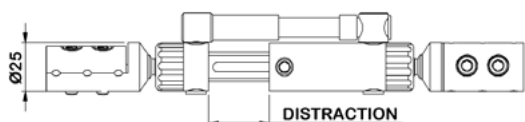

Intended use : Temporary fixation of fractures, nonunions, malunions, osteotomies, psuedarthrosis, of humerus, arthrodesis of elbow joint. Especially used for fixation of open fractures of humerus and for distraction and compression purposes on fracture site.

| available as aluminium/stainless steel/peek.

Ayfix Dynamic Axial External Fixator T-Clamp Humerus



Half-Pin (Schanz Screw) to be used
Ø (4,0/4,5/5,0 mm)

Allen Wrench to be used
Ø (5,0 mm)

CAT. NO	TYPE	DISTRACTION (mm)	LENGTH (mm)
A600 16 101 0001	Long	51	207
A600 16 101 0002	Medium	31	187
A600 16 101 0003	Short	11	167

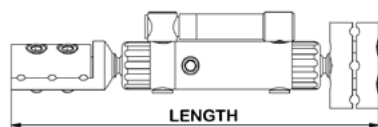
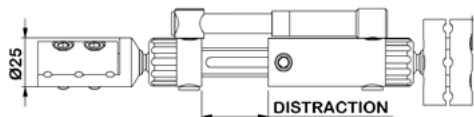

Intended use : Temporary fixation of fractures, nonunions, malunions, osteotomies, psuedarthrosis, of proximal humerus, arthrodesis of shoulder joint. Especially used for fixation of open fractures of proximal humerus and for distraction and compression purposes on fracture

| available as aluminium/stainless steel/peek.

Ayfix Dynamic Axial External Fixators

Ayfix Limb Lengthening External Fixator Humerus



Half-Pin (Schanz Screw) to be used
Ø (4,0/4,5/5,0 mm)

Allen Wrench to be used
Ø (5,0 mm)

CAT. NO	TYPE	DISTRACTION (mm)	LENGTH (mm)
A600 16 100 0010	Long	81	215
A600 16 100 0011	Medium	61	195
A600 16 100 0012	Short	41	175

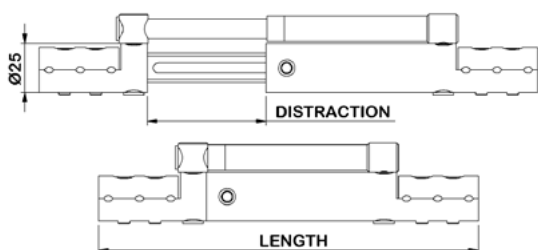

Intended use : Temporary fixation of fractures, nonunions, malunions, osteotomies, pseduarthrosis, of humerus, arthrodesis of elbow joint. Especially used for fixation of open fractures of humerus and for distraction and compression purposes on fracture site also used for lengthening purposes of humerus bone.

| available as aluminium/stainless steel/peek.

Ayfix Dynamic External Fixator Forearm

Allen Wrench to be used
Ø (5,0 mm)



Half-Pin (Schanz Screw) to be used
Ø (3,5/4,0/4,5 mm)

CAT. NO	TYPE	DISTRACTION (mm)	LENGTH (mm)
A600 17 100 0001	Long	42	200
A600 17 100 0002	Medium	22	180
A600 17 100 0003	Short	14	168

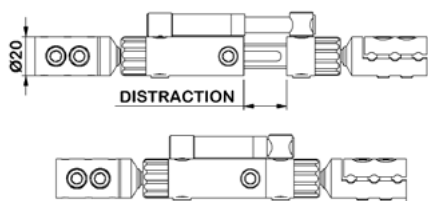

Intended use : Temporary fixation of fractures, nonunions, malunions, osteotomies, pseduarthrosis, of ulna and radius, arthrodesis of wrist joint. Especially used for fixation of open fractures of ulna and radius and for distraction and compression purposes on fracture site. Also used for lengthening purposes ulna and radius. It is used for temporary fixation of PEDIATRIC FEMUR & TIBIA FRACTURES .

| available as aluminium/stainless steel/peek.

Ayfix Dynamic Axial External Fixators

Ayfix Colles Type Wrist Fixator



Allen Wrench to be used
Ø (3,0/4,0/5,0 mm)

Half-Pin (Schanz Screw) to be used
Ø (2,5/3,0/3,5 mm)

CAT. NO.	LENGTH (mm)
A600 12 110 0010	218

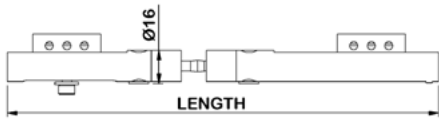

Intended use : Temporary fixation of fractures, nonunions, malunions, osteotomies, psuedarthrosis, of distal radius, arthrodesis of wrist joint. Especially used for fixation of open and/or communitated intra-articular fractures of distal radius and for distraction and compression purposes on fracture site.

| available as aluminium/stainless steel/peek.

Wrist Fixator



Half-Pin (Schanz Screw) to be used
Ø (2,5/3,0/3,5 mm)

Allen Wrench to be used
Ø (4,0 mm)

CAT. NO.	LENGTH (mm)
A600 12 110 0011	210

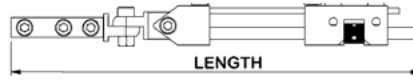

Intended use : Temporary fixation of fractures, nonunions, malunions, osteotomies, psuedarthrosis, of distal radius, arthrodesis of wrist joint. Especially used for fixation of open and/or communitated intra-articular fractures of distal radius and for distraction and compression purposes on fracture site.

Penning Type Wrist Fixator



Allen Wrench to be used
Ø (3,0/4,0 mm)

Half-Pin (Schanz Screw) to be used
Ø (2,5/3,0/3,5 mm)

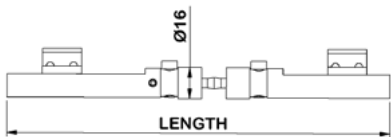

Intended use : Temporary fixation of fractures, nonunions, malunions, osteotomies, psuedarthrosis, of distal radius, arthrodesis of wrist joint. Especially used for fixation of open and/or communitated intra-articular fractures of distal radius and for distraction and compression purposes on fracture site.

| available as aluminium/stainless steel/peek.

CAT. NO	TYPE	LENGTH (mm)
A600 12 110 0012	SHORT	190
A600 12 110 0013	LONG	220

Ayfix Dynamic Axial External Fixators

Ayfix Pelvis Fixator



Half-Pin (Schanz Screw) to be used
Ø (5,0/5,5/6,0 mm)

CAT. NO	TYPE	DISTRACTION (mm)	LENGTH (mm)
A600 25 000 0000	LONG	60	373
A600 25 000 0001	STANDARD	40	333

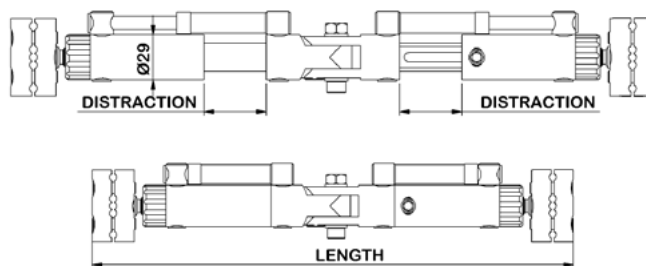

Intended use : Temporary fixation of fractures, osteotomies of pelvis in adults. Especially used for fixation of open and/or communitated fractures of pelvis.

| available as aluminium/stainless steel/peek.

Ayfix Pediatric Pelvis Fixator



Half-Pin (Schanz Screw) to be used
Ø (4,0/4,5/5,0 mm)

CAT. NO	DISTRACTION (mm)	LENGTH (mm)
A600 25 000 0110	25	275

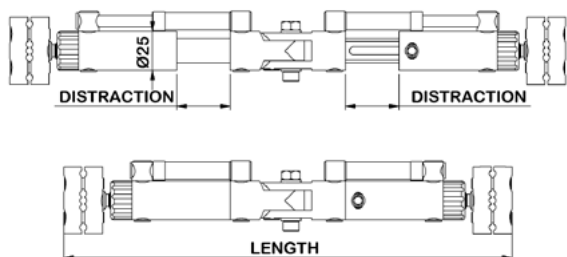

Intended use : Temporary fixation of fractures, osteotomies of pelvis in adolescents.. Especially used for fixation of open and/or communitated fractures of pelvis.

| available as aluminium/stainless steel/peek.

Ayfix Dynamic Axial External Fixators

Dynamic Axial Knee Fixator



Allen Wrench to be used
Ø (6,0 mm)

Half-Pin (Schanz Screw) to be used
Ø (5,0/5,5/6,0 mm)

CAT. NO	DISTRACTION (mm)	LENGTH (mm)
A600 15 100 0002	71,5	350

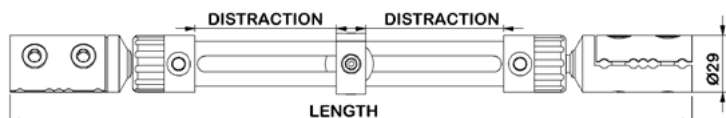

Intended use : Temporary fixation of fractures, nonunions, malunions, osteotomies, pseduarthrosis, of distal femur and proximal tibia, arthrodesis of knee joint. Especially used for fixation of open and communitated fractures of distal femur and proximal tibia and for distraction and compression purposes on knee joint.

| available as aluminium/stainless steel/peek.

Dynamic Axial Elbow Fixator



Allen Wrench to be used
Ø (5,0 mm)

Half-Pin (Schanz Screw) to be used
Ø (3,5/4,0/4,5 mm)

CAT. NO	DISTRACTION (mm)	LENGTH (mm)
A600 15 100 0001	59	298

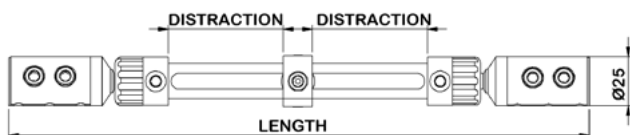

Intended use : Temporary fixation of fractures, nonunions, malunions, osteotomies, pseduarthrosis, of distal humerus and proximal radius/ulna, arthrodesis of elbow joint. Especially used for fixation of open and communitated fractures of distal humerus and proximal radius/ulna and for distraction and compression purposes on elbow joint.

| available as aluminium/stainless steel/peek.

Ayfix Dynamic Axial External Fixators

Ayfix Limb Reconstruction Fixator Femur-Tibia



Half-Pin (Schanz Screw) to be used
Ø (5,0/5,5/6,0 mm)

Allen Wrench to be used
Ø (6,0 mm)

CAT. NO	TYPE	DISTRACTION (mm)	LENGTH (mm)
A600 11 100 0010	Long	140	400
A600 11 100 0013	Medium	90	300
A600 11 100 0012	Short	40	250

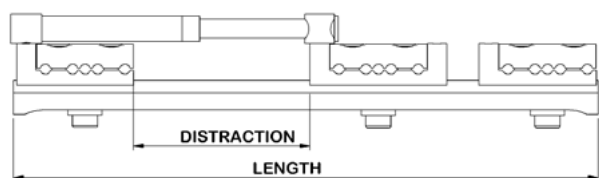

Intended use : Temporary fixation of fractures, nonunions, malunions, osteotomies, psuedarthrosis, of femur and tibia, arthrodesis of knee and ankle joints. Especially used for the treatment of reconstruction of femoral and tibial bone defects by sliding distal or proximal osteotomized bone with elongation of fibrous callus at osteotomy site. (new bone formation/ reconstruction of femoral and tibial bone defects. For adult patients.

| available as aluminium/stainless steel/peek.

Ayfix Limb Reconstruction Pediatric Fixator

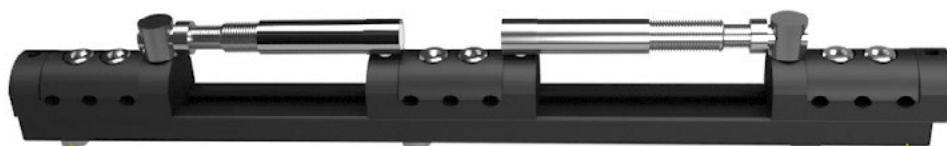

Half-Pin (Schanz Screw) to be used
Ø (4,0/4,5/5,0 mm)

Allen Wrench to be used
Ø (5,0 mm)

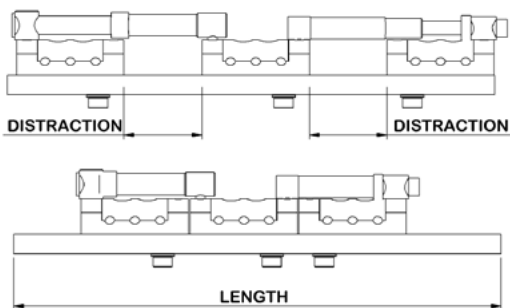

CAT. NO	TYPE	DISTRACTION (mm)	LENGTH (mm)
A600 11 101 0010	Long	90	250
A600 11 101 0013	Medium	90	200
A600 11 101 0012	Short	45	150

Intended use : Temporary fixation of fractures, nonunions, malunions, osteotomies, psuedarthrosis, of femur and tibia, arthrodesis of knee and ankle joints. Especially used for the treatment of reconstruction of femoral and tibial bone defects by sliding distal or proximal osteotomized bone with elongation of fibrous callus at osteotomy site. (new bone formation/ reconstruction of femoral and tibial bone defects. For pediatric patients.

| available as aluminium/stainless steel/peek.

Ayfix Dynamic Axial External Fixators

Polyaxial Femur-Tibia External Fixator

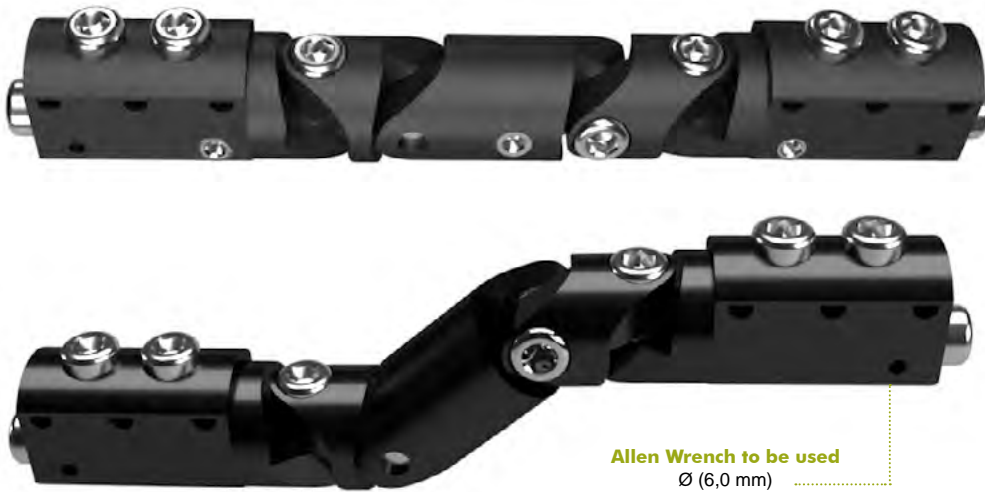

CAT. NO	LENGTH (mm)
A600 11 115 0000	245

Allen Wrench to be used
Ø (6,0 mm)

Half-Pin (Schanz Screw) to be used
Ø (5,0/5,5/6,0 mm)

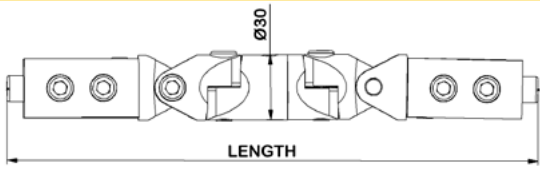

Intended use : Temporary fixation of fractures, nonunions, malunions, osteotomies, pseduarthrosis, of femur/tibia. Especially used for fixation of open fractures of femur/ tibia and for distraction and compression purposes on fracture site.

| available as aluminium/stainless steel/peek.

Polyaxial Humerus External Fixator



CAT. NO	LENGTH (mm)
A600 11 120 0000	170

Allen Wrench to be used
Ø (5,0/6,0 mm)

Half-Pin (Schanz Screw) to be used
Ø (4,0/4,5/5,0 mm)

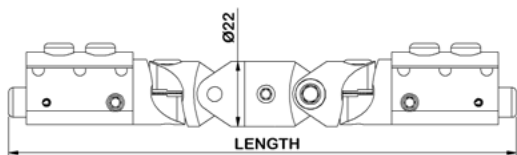

Intended use : Temporary fixation of fractures, nonunions, malunions, osteotomies, pseduarthrosis, of humerus,Especially used for fixation of open fractures of humerus and for distraction and compression purposes on fracture site.

| available as aluminium/stainless steel/peek.

Ayfix Dynamic Axial External Fixators

Ayfix Pertrochanteric Fixator

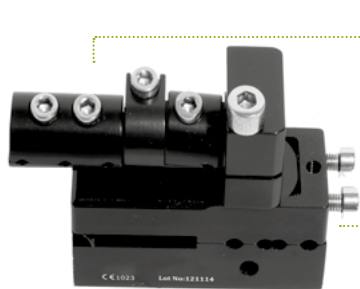

Allen Wrench to be used
Ø (6,0 mm)

Half-Pin (Schanz Screw) to be used
Ø (5,0/5,5/6,0 mm)

CAT. NO.	LENGTH (mm)
A600 12 120 0003	117,4

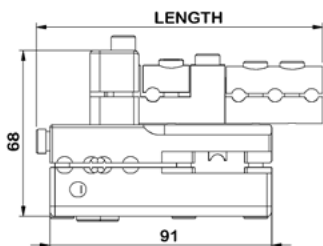

Intended use : Temporary fixation of fractures, nonunions, malunions, osteotomies, pseduarthrosis, of proximal femur. Especially used for fixation of open fractures of proximal femur. Especially used for fixation of fractures of proximal femur(intertrochanteric, pertrochanteric) in elderly patients for early mobilization, for distraction and compression purposes on fracture site.

Hybrid External Fixator Femur-Tibia



Allen Wrench to be used
Ø (6,0 mm)

Rings to be used : Ø (160 mm)

Half-Pin (Schanz Screw) to be used
: Ø (4,5/5,0/5,5/6,0 mm)

CAT. NO.	LENGTH (mm)
A600 11 014 0005	230,5

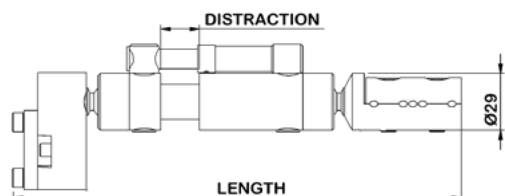

Intended use : Temporary fixation of fractures, nonunions, malunions, osteotomies, pseduarthrosis, of proximal femur. Especially used for fixation of open fractures of proximal femur. Especially used for fixation of fractures of proximal femur(intertrochanteric, pertrochanteric) in elderly patients for early mobilization. and for distraction and compression purposes on fracture site.

Ayfix Dynamic Axial External Fixators

Hybrid External Fixator Wrist



CAT. NO.	LENGTH (mm)
A600 25 001 0025	174,3

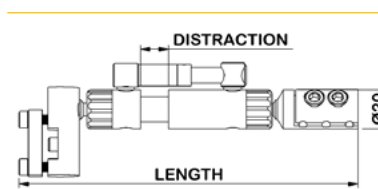

Intended use : Temporary fixation of fractures, nonunions, malunions, osteotomies, pseduarthrosis, of distal radius and ulna, arthrodesis of wrist joint. Especially used for fixation of open fractures of distal radius and ulna and for distraction and compression purposes on fracture site. This fixator provides multiplanar and stronger fixation when needed.

Hybrid External Fixator Finger



CAT. NO.	LENGTH (mm)
A600 25 001 0026	57,4

Ayfix Finger Fixator

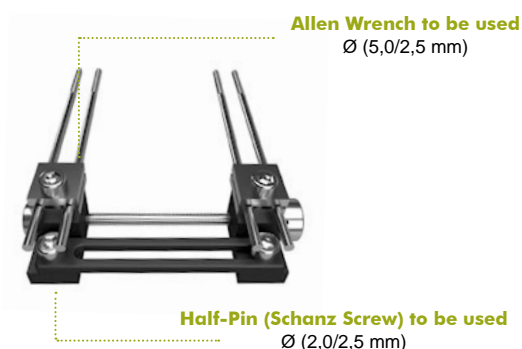

CAT. NO.	LENGTH (mm)
A600 12 120 0001	72,7

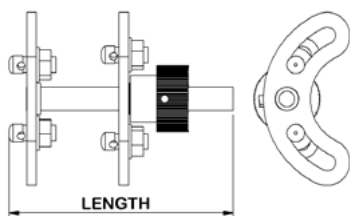

Intended use : Temporary fixation of fractures, nonunions, malunions, osteotomies, pseduarthrosis, of metacarpal, metatarsal and phalangeal bones, arthrodesis of metacarpophalangeal and interphalangeal joints. Especially used for fixation of open fractures of for distraction and compression purposes on fracture site and joints. This fixator provides multiplanar and stronger fixation when needed.

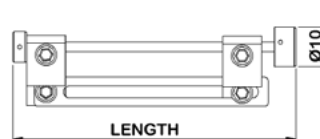

Intended use : Temporary fixation of fractures, nonunions, malunions, osteotomies, pseduarthrosis, of metacarpal, metatarsal, phalangeal bones. Arthrodesis of metacarpophalangeal and interphalangeal joints. Especially used for fixation of open fracture, for lengthening purposes of metacarpal metatarsal, phalangeal bones.

Mini Rail External Fixators

Mini Rail Fixator Short

Allen Wrench to be used
Ø (3,0 mm)

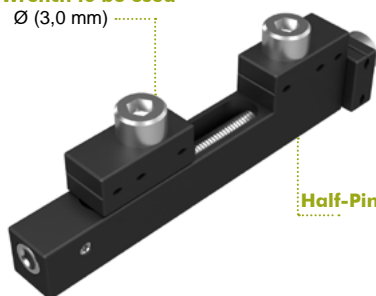

Half-Pin (Schanz Screw) to be used
Ø (1,5/2,0/2,5 mm)

CAT. NO	DISTRACTION (mm)	LENGTH (mm)
A600 12 120 0005	19,5	71,5

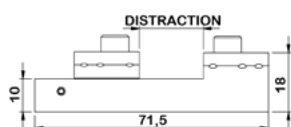

Intended use : Temporary fixation of fractures, nonunions, malunions, osteotomies, pseduarthrosis, of metacarpal & metatarsal bones. Arthrodesis of metametacarpophalangeal & metatarsophalangeal joints. Especially used for fixation of open fracture, for lengthening purposes of metacarpal & metatarsal bones.

| available as aluminium/stainless steel/peek.

Mini Rail Fixator Medium

Allen Wrench to be used
Ø (3,0 mm)

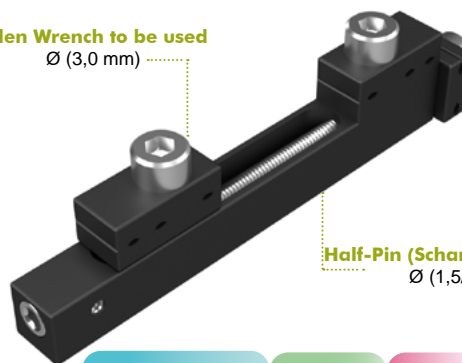

Half-Pin (Schanz Screw) to be used
Ø (1,5/2,0/2,5 mm)

CAT. NO	DISTRACTION (mm)	LENGTH (mm)
A600 12 120 0006	29,5	81,5

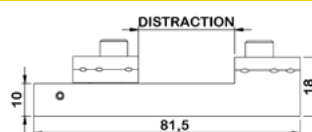

Intended use : Temporary fixation of fractures, nonunions, malunions, osteotomies, pseduarthrosis, of metacarpal & metatarsal bones. Arthrodesis of metametacarpophalangeal & metatarsophalangeal joints. Especially used for fixation of open fracture, for lengthening purposes of metacarpal & metatarsal bones.

| available as aluminium/stainless steel/peek.

Mini Rail Fixator Long

Allen Wrench to be used
Ø (3,0 mm)

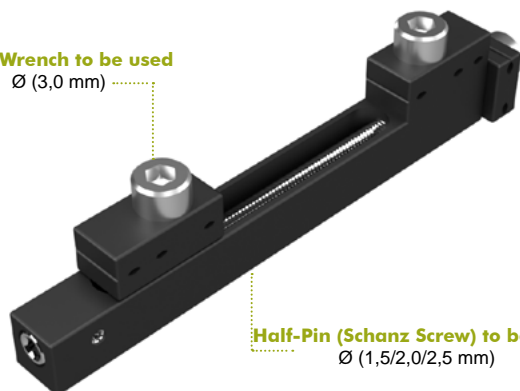

Half-Pin (Schanz Screw) to be used
Ø (1,5/2,0/2,5 mm)

CAT. NO	DISTRACTION (mm)	LENGTH (mm)
A600 12 120 0007	39,5	91,5

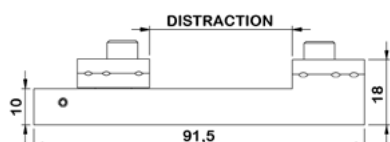

Intended use : Temporary fixation of fractures, nonunions, malunions, osteotomies, pseduarthrosis, of metacarpal, metatarsal, occasionally ulna, radius bones. Arthrodesis of metacarpophalangeal, matatarsophalangeal & occasionally wrist joints. Especially used for fixation of open fracture, for lengthening purposes of matacarpal, metatarsal, occasionally ulna, radius bones.

| available as aluminium/stainless steel/peek.

Mini Rail Fixator X Long

Allen Wrench to be used
Ø (3,0 mm)



Half-Pin (Schanz Screw) to be used
Ø (1,5/2,0/2,5 mm)

CAT. NO	DISTRACTION (mm)	LENGTH (mm)
A600 12 120 0002	69,5	121,5

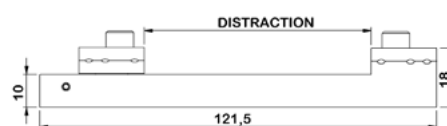

Intended use : Temporary fixation of fractures, nonunions, malunions, osteotomies, pseduarthrosis, of metacarpal, metatarsal, occasionally ulna, radius bones. Arthrodesis of metacarpophalangeal, matatarsophalangeal & occasionally wrist joints. Especially used for fixation of open fracture, for lengthening purposes of matacarpal, metatarsal, occasionally ulna, radius bones.

| available as aluminium/stainless steel/peek.

Mini Rail External Fixators

Mini Rail Fixator XX Long



CAT. NO	DISTRACTION (mm)	LENGTH (mm)
A600 12 120 0000	106,5	158,5

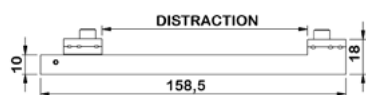

Intended use : Temporary fixation of fractures, nonunions, malunions, osteotomies, pseduarthrosis, of metacarpal, metatarsal, occasionally ulna, radius bones. Arthrodesis of metacarpophalangeal, matatarsophalangeal & occasionally wrist joints. Especially used for fixation of open fracture, for lengthening purposes of maticarpal, metatarsal, occasionally ulna, radius bones.

| available as aluminium/stainless steel/peek.

Mini Rail Fixator Vertical Axis

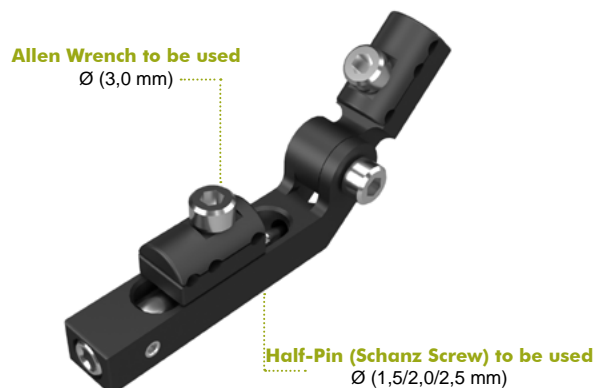

CAT. NO	DISTRACTION (mm)	LENGTH (mm)
A600 12 120 0009	11,7	71,5

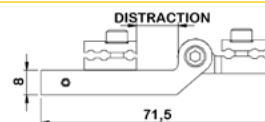

Intended use : Temporary fixation of fractures, nonunions, malunions, osteotomies, pseduarthrosis, of metacarpal & metatarsal bones. Arthrodesis of metametacarpophalangeal & metatarsophalangeal joints. Especially used for fixation of open fracture, for lengthening purposes of metacarpal & metatarsal bones.

| available as aluminium/stainless steel/peek.

Mini Rail Fixator Horizontal Axis

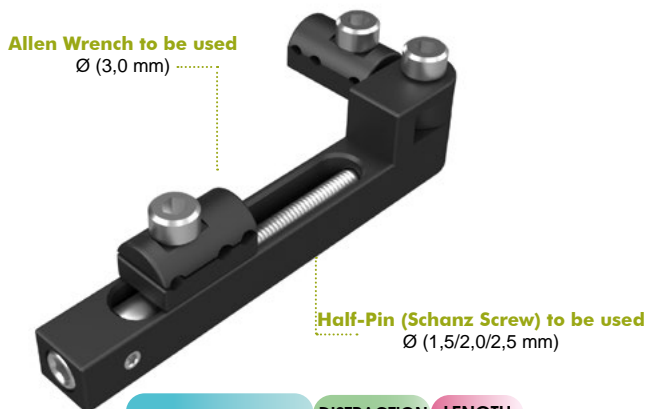

CAT. NO	DISTRACTION (mm)	LENGTH (mm)
A600 12 120 0008	27,5	90



Intended use : Temporary fixation of fractures, nonunions, malunions, osteotomies, pseduarthrosis, of metacarpal & metatarsal bones. Arthrodesis of metametacarpophalangeal & metatarsophalangeal joints. Especially used for fixation of open fracture, for lengthening purposes of metacarpal & metatarsal bones.

| available as aluminium/stainless steel/peek.

Mini Rail Fixator Horizontal Axis 90°

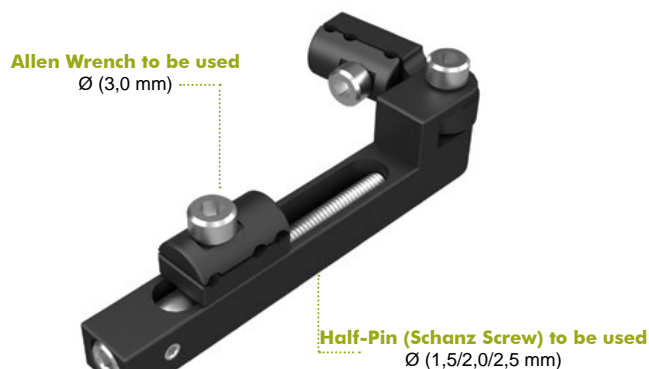

CAT. NO	DISTRACTION (mm)	LENGTH (mm)
A600 12 120 0010	27,5	91

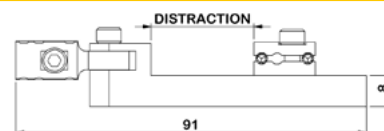

Intended use : Temporary fixation of fractures, nonunions, malunions, osteotomies, pseduarthrosis, of metacarpal & metatarsal bones. Arthrodesis of metametacarpophalangeal & metatarsophalangeal joints. Especially used for fixation of open fracture, for lengthening purposes of metacarpal & metatarsal bones.

| available as aluminium/stainless steel/peek.

Tubular External Fixators

Tubular Fixator Rod-Rod Clamp



ALUMINIUM	ROD DIAMETER (mm)
A600 11 006 0001	5,0
A600 11 014 0001	8,0
A600 11 010 0001	10,0

| available as aluminium/stainless steel/peek.

Tubular Fixator Rod-Pin Clamp



ALUMINIUM	ROD DIAMETER (mm)	SCREW DIAMETER (mm)
A600 11 006 0002	5,0	2,5-3,0-3,5
A600 11 014 0002	8,0	3,5-4,0-4,5
A600 11 010 0002	10,0	5,0-5,5-6,0

| available as aluminium/stainless steel/peek.

Tubular External Fixators

Tubular Fixator Carbon Rod



CARBON	DIAMETER x LENGTH (mm)
A600 11 005 0050	5,0X50
A600 11 005 0100	5,0X100
A600 11 005 0150	5,0X150
A600 11 005 0200	5,0X200
A600 11 005 0250	5,0X250
A600 11 005 0300	5,0X300
A600 11 005 0350	5,0X350
A600 11 006 0080	6,0X80
A600 11 006 0100	6,0X100
A600 11 006 0150	6,0X150
A600 11 006 0200	6,0X200
A600 11 006 0250	6,0X250
A600 11 006 0300	6,0X300
A600 11 006 0350	6,0X350
A600 11 008 0050	8,0X50
A600 11 008 0100	8,0X100
A600 11 008 0150	8,0X150

CARBON	DIAMETER x LENGTH (mm)
A600 11 008 0200	8,0X200
A600 11 008 0250	8,0X250
A600 11 008 0300	8,0X300
A600 11 008 0350	8,0X350
A600 11 010 0100	10,0X100
A600 11 010 0150	10,0X150
A600 11 010 0200	10,0X200
A600 11 010 0250	10,0X250
A600 11 010 0300	10,0X300
A600 11 010 0350	10,0X350
A600 11 014 0100	14,0X100
A600 11 014 0150	14,0X150
A600 11 014 0200	14,0X200
A600 11 014 0250	14,0X250
A600 11 014 0300	14,0X300
A600 11 014 0350	14,0X350

Tubular Fixator Multiple Pin Clamp



ALUMINIUM	DIAMETER (mm)
A600 11 006 0003	5,0
A600 11 014 0003	8,0
A600 11 010 0003	10,0

| available as aluminium/stainless steel/peek.

Tubular External Fixators

Tubular Fixator Straight Support



SS	DIAMETER (mm)
A600 11 005 0004	5,0
A600 11 008 0004	8,0
A600 11 010 0007	10,0

Tubular Fixator 30° Angled Support



SS	DIAMETER (mm)
A600 29 121 0120	5,0
A600 29 121 0080	8,0
A600 29 121 0100	10,0

Tubular Fixator Multiple Pin T Clamp



ALUMINIUM	DIAMETER (mm)
A600 11 006 0004	5,0
A600 11 014 0004	8,0
A600 11 010 0004	10,0

| available as aluminium/stainless steel/peek.

Tubular Fixator Semi Circular Rod



SS	DIAMETER x LENGTH (mm)
A600 10 151 0160	8,0X160
A600 10 151 0180	8,0X180
A600 10 151 0200	8,0X200
A600 10 121 0160	10,0X160
A600 10 121 0180	10,0X180
A600 10 121 0200	10,0X200

Tubular Fixator Compression Distraction Tube



ALUMINIUM	DIAMETER x LENGTH (mm)
A600 11 007 0022	8,0X200

Tubular External Fixators

Tubular Fixator Ankle Hinge



SS	DIAMETER x LENGTH (mm)
A600 11 007 0020	8,0x200

Tubular Fixator Elbow-Wrist Hinge



SS	DIAMETER x LENGTH (mm)
A600 11 007 0019	5,0x200



Hybrid External Fixators

Hybrid Fixator Aluminium 2/3 Ring



CAT. NO	DIAMETER (mm)
A600 11 007 0014	155
A600 11 007 0016	185
A600 11 007 0018	215

available as aluminium/stainless steel/peek.

Hybrid Fixator Aluminium 1/3 Ring



CAT. NO	DIAMETER (mm)
A600 11 008 0014	155
A600 11 008 0016	185
A600 11 008 0018	215

available as aluminium/stainless steel/peek.

Hybrid Fixator Three Hole Sliding Wire Clamp



CAT. NO.
A600 11 008 0026

available as aluminium/stainless steel/peek.

Washer



SS	DIAMETER (mm)
A600 10 030 0012	12
A600 10 030 0013	14

Hybrid Fixator Two Hole Wire Securing Pin



SS
A600 10 153 0001

Hybrid External Fixators

Olive Wire



CAT. NO	DIA. x LENGTH (mm)
A600 10 188 2030	2,0X300
A600 10 188 2040	2,0X400

Trocar Pointed Wire



SS	DIAMETER (mm)	LENGTH (mm)
A600 10 100 2030	2,0	300
A600 10 100 2040	2,0	400

Hybrid Fixator Independent Wire Clamp



SS
A600 11 008 0024

Hybrid Fixator Supplementary Pin Holder Clamp



CAT. NO
A600 11 008 0025

| available as aluminium/stainless steel/peek.

Hybrid Fixator Carbon Rod



CAT. NO
A600 11 006 0060

Hybrid External Fixators

Wire Fixation Bolt



SS
A600 10 090 0000

Hybrid Fixator Straight Posts



SS
A600 11 008 0021

Hybrid Fixator 30° Angled Posts



SS
A600 11 008 0022

Half Pin Universal Retaining Bolt



SS
A600 10 099 0001

Connection Bolt (M6)



SS	LENGTH (mm)
A600 10 020 0025	25
A600 10 020 0030	30

Spiked Washer



SS
A600 10 032 0000

Nut M6



SS
A600 10 021 0000

Hybrid Fixator Single Pin Clamp



SS
A600 11 007 0012

Hybrid Fixator Hinge Clamp



| available as aluminium/stainless steel/peek.

CAT. NO
A600 11 008 0019

Hybrid External Fixators

Hybrid Fixator Kit



CAT. NO

A600 11 007 0023

| available as aluminium/stainless steel/peek.

Hybrid Fixator Translation Rotation Hinge

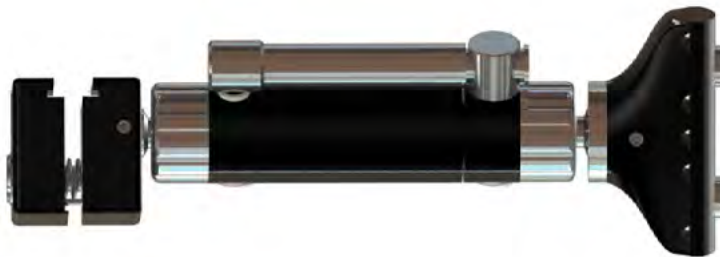

CAT. NO

A600 11 008 0020

| available as aluminium/stainless steel/peek.

Hybrid Fixator Telescopic Reduction Unit



CAT. NO

A600 11 007 0021

| available as aluminium/stainless steel/peek.

Square Socket

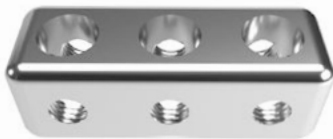

SS

HOLES

A600 14 002 0001	1
A600 14 002 0002	2
A600 14 002 0003	3
A600 14 002 0004	4

| available as aluminium/stainless steel/peek.

Hybrid Fixator Extension Plate



SS

A600 11 050 2251

Hybrid External Fixators

Threaded Rod (M6)

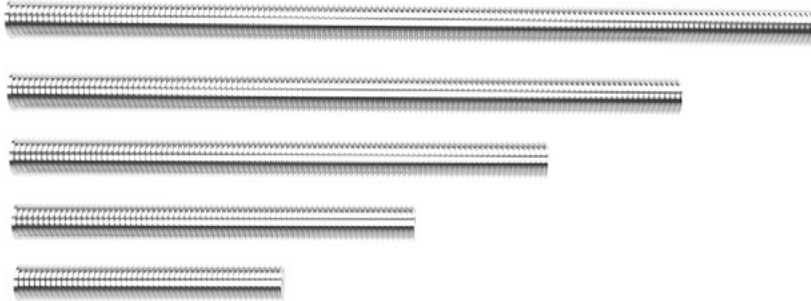

SS	LENGTH (mm)
A600 10 050 0050	50
A600 10 050 0075	75
A600 10 050 0100	100
A600 10 050 0115	115
A600 10 050 0125	125
A600 10 050 0150	150
A600 10 050 0175	175
A600 10 050 0200	200
A600 10 050 0250	250
A600 10 050 0300	300



Circular External Fixators

Half Ring



ALUMINIUM	DIAMETER (mm)
A600 10 120 0080	80
A600 10 120 0100	100
A600 10 120 0120	120
A600 10 120 0130	130
A600 10 120 0140	140
A600 10 120 0150	150
A600 10 120 0160	160
A600 10 120 0170	170
A600 10 120 0180	180
A600 10 120 0200	200
A600 10 120 0220	220

5/8 C Ring



ALUMINIUM	DIAMETER (mm)
A600 10 150 0080	80
A600 10 150 0100	100
A600 10 150 0120	120
A600 10 150 0140	140
A600 10 150 0150	150
A600 10 150 0160	160
A600 10 150 0170	170
A600 10 150 0180	180
A600 10 150 0200	200
A600 10 150 0220	220

3/4 Foot Ring

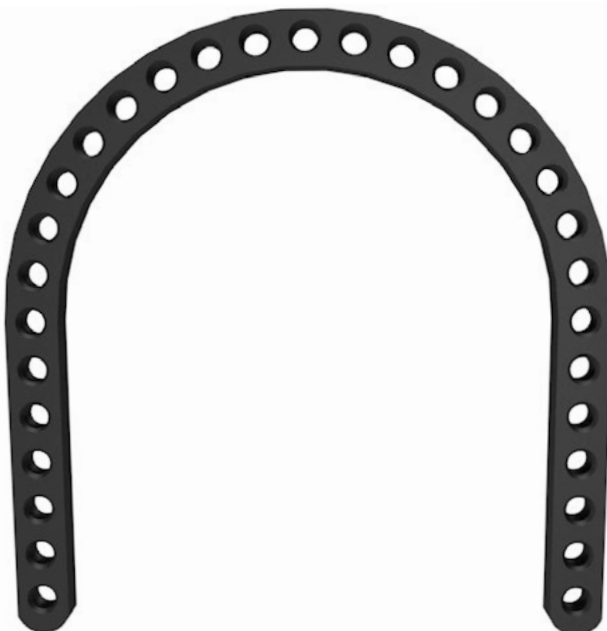

ALUMINIUM	DIAMETER (mm)
A600 29 120 0220	80
A600 29 120 0100	100
A600 29 120 0120	120
A600 29 120 0140	140
A600 29 120 0160	160

Circular External Fixators

Femur Arch



ALUMINIUM	SS	ANGLE/DIAMETER (mm)
A601 10 160 0090	A601 11 160 0090	90° / Ø 160
A601 10 180 0090	A601 11 180 0090	90° / Ø 180
A601 10 200 0090	A601 11 200 0090	90° / Ø 200
A601 10 160 0120	A601 11 160 0120	120° / Ø 160
A601 10 180 0120	A601 11 180 0120	120° / Ø 180
A601 10 200 0120	A601 11 200 0120	120° / Ø 200

Multiple Pin Fixation Clamp



SS
A601 10 013 0000
A601 10 013 0001
A601 10 013 0002
A601 10 013 0003

Oblique Support Connector



SS	LENGTH (mm)
A600 10 080 0000	30
A600 10 080 0001	58
A600 10 080 0002	82

Adjustable Clamp



SS
A600 10 001 0001

Telescopic Rod



SS	LENGTH (mm)
A600 10 071 0100	100
A600 10 071 0125	125
A600 10 071 0150	150
A600 10 071 0175	175
A600 10 071 0215	215

Double Female Hinge



SS
A601 10 099 0010

Circular External Fixators

Male Half Hinge



SS

A601 10 099 0015

Female Half Hinge



SS

A601 10 099 0020

Cannulated Bolt



SS

A600 10 090 0001

Slotted Bolt



SS

A600 10 091 0000

Half Pin Universal Retaining Bolt



SS

A600 10 099 0001

Single Pin Fixation Bolt



SS

A601 10 010 0000

Female Support



SS

HOLES

**LENGTH
(mm)**

A600 10 065 0000	1	23
A600 10 065 0002	2	32
A600 10 065 0003	3	41

Male Support



SS

HOLES

**LENGTH
(mm)**

A600 10 060 0112	1	33
A600 10 060 0222	2	42
A600 10 060 0332	3	51

Circular External Fixators

Connection Bolt (M6)



SS	LENGTH (mm)
A600 10 020 0016	16
A600 10 020 0020	20
A600 10 020 0025	25
A600 10 020 0030	30

Connecting Plate



SS	HOLES	LENGTH (mm)
A600 10 050 2035	2	41
A600 10 050 3050	3	51
A600 10 050 4060	4	61
A600 10 050 5070	5	71
A600 10 050 6085	6	81
A600 10 050 7100	7	91
A600 10 050 8110	8	101

Connecting Plate with Threaded End



SS	HOLES	LENGTH (mm)
A600 11 050 2131	5	131
A600 11 050 2171	7	171
A600 11 050 2211	9	211

90 ° Angled Connection Plate



SS	HOLES	LENGTH (mm)
A600 14 000 1150	2	50
A600 14 000 1175	4	75

Twisted Plate



SS	HOLES	LENGTH (mm)
A600 10 054 0046	2	50
A600 10 054 0067	3	70
A600 10 054 0088	4	90

Universal Hinge



SS
A601 15 000 0000

Curved Plate



ALUMINIUM
A601 15 000 0020

Circular External Fixators

Square Socket



SS	HOLES
A600 14 002 0001	1
A600 14 002 0002	2
A600 14 002 0003	3
A600 14 002 0004	4

Square Socket Centering Sleeve



SS	DIAMETER (mm)
A600 14 002 0605	6

Washer



SS	DIAMETER (mm)
A600 10 030 0012	12
A600 10 030 0013	14

Slotted Washer



SS
A600 10 034 0000

Oval Washer



SS	DIAMETER (mm)
A600 10 031 0012	12

Conical Washer



SS
A600 10 110 0001

Star Washer



SS
A600 10 032 0000

Nut M6



SS
A600 10 021 0000

Circular External Fixators

Threaded Rod (M6)

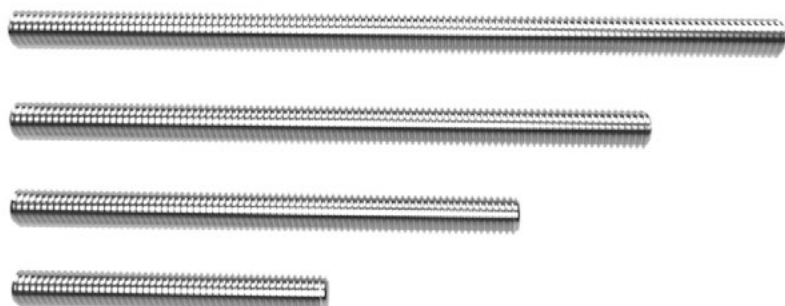

SS	LENGTH (mm)
A600 10 050 0050	50
A600 10 050 0075	75
A600 10 050 0100	100
A600 10 050 0115	115
A600 10 050 0125	125
A600 10 050 0150	150
A600 10 050 0175	175
A600 10 050 0200	200
A600 10 050 0250	250
A600 10 050 0300	300
A600 10 050 0350	350
A600 10 050 0400	400

Lengthening Rod (M6)



CAT. NO	LENGTH (mm)
A600 10 011 0060	60
A600 10 011 0080	80
A600 10 011 0100	100
A600 10 011 0120	120
A600 10 011 0150	150
A600 10 011 0200	200

Slotted Rod (M6)

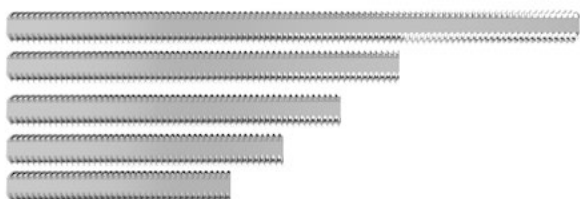

SS	LENGTH (mm)
A600 08 011 0040	40
A600 08 011 0050	50
A600 08 011 0060	60
A600 08 011 0070	70
A600 08 011 0100	100

Trocar Pointed Wire



SS	DIA x LENGTH (mm)
A600 10 100 1830	1,8X300
A600 10 100 1840	1,8X400
A600 10 100 2030	2,0X300
A600 10 100 2040	2,0X400

Circular External Fixators

Bayonet Pointed Wire



SS	DIA x LENGTH (mm)
A600 10 139 1830	1,8X300
A600 10 139 1840	1,8X400
A600 10 139 2030	2,0X300
A600 10 139 2040	2,0X400

Olive Wire



SS	DIA x LENGTH (mm)
A600 10 188 1830	1,8X300
A600 10 188 1840	1,8X400
A600 10 188 2030	2,0X300
A600 10 188 2040	2,0X400

Hybrid External Fixator (For adaptation to External Circular Fixation System)



Half-Pin (Schanz Screw) to be used
 Ø (2,5/3,0/3,5/4,0 mm) - MEDIUM
 Ø (4,5/5,0/5,5/6,0 mm) - LONG

CAT.NO	TYPE	LENGTH (mm)
A600 25 001 0025	Medium	230
A600 11 014 0005	Long	250

Pediatric Circular External Fixators

Pediatric Half Ring



ALUMINIUM	DIAMETER (mm)
A600 11 121 0070	70
A600 11 121 0080	80
A600 11 121 0090	90
A600 11 121 0100	100
A600 11 121 0110	110
A600 11 121 0120	120

Pediatric 5/8 C Ring



ALUMINIUM	DIAMETER (mm)
A600 11 151 0070	70
A600 11 151 0080	80
A600 11 151 0090	90
A600 11 151 0100	100
A600 11 151 0110	110
A600 11 151 0120	120

Pediatric Femur Arch



ALUMINIUM	ANGLE	DIAMETER (mm)
A601 11 090 0090	90°	90
A601 11 110 0090	90°	110
A601 11 090 0120	120°	90
A601 11 110 0120	120°	110

Pediatric Adjustable Clamp



SS
A600 11 002 0002

Pediatric Multiple Pin Fixation Clamp



SS
A601 11 014 0000

Pediatric Circular External Fixators

Pediatric Slotted Bolt



SS

A600 11 091 0000

Pediatric Oblique Support Connector



SS

**LENGTH
(mm)**

A600 11 080 0000

25

A600 11 080 0001

50

A600 11 080 0002

75

Pediatric Cannulated Bolt



SS

A600 11 090 0000

Pediatric Telescopic Rod



SS

A600 11 072 0001

Pediatric Half Pin Universal Retaining Bolt



SS

A600 11 099 0001

Pediatric Male Half Hinge



SS

A601 11 099 0015

Pediatric Female Half Hinge



SS

A601 11 099 0020

Pediatric Lengthening Rod



CAT. NO.

A601 11 001 0101

Pediatric Circular External Fixators

Pediatric Double Female Hinge



SS

A601 11 099 0010

Pediatric Connecting Plate



SS	HOLES	LENGTH (mm)
A600 11 050 2035	2	25
A600 11 050 3050	3	45
A600 11 050 4060	4	55
A600 11 050 5070	5	65

Pediatric Universal Hinge



SS

A601 16 000 0000

Pediatric Washer



SS

A600 11 030 0101

Pediatric Star Washer



SS

A600 11 032 0000

Pediatric Curved Plate



ALUMINIUM

A601 16 000 0020

Pediatric Nut (M5)



SS

A600 11 021 0000

Pediatric Slotted Washer



SS

A600 11 034 0000

Pediatric Oval Washer



SS

A600 11 031 0101

Pediatric Circular External Fixators

Pediatric Square Socket



SS	HOLES
A600 16 002 0001	1
A600 16 002 0002	2
A600 16 002 0003	3
A600 16 002 0004	4

Pediatric Square Socket Centering Sleeve



SS	DIAMETER (mm)
A600 14 002 0305	3
A600 14 002 0405	4
A600 14 002 0505	5

Pediatric Male Support



SS	HOLES	LENGTH (mm)
A600 11 060 0112	1	31,5
A600 11 060 0222	2	40,5
A600 11 060 0332	3	49,5

Pediatric Connection Bolt (M5)



SS	LENGTH (mm)
A600 11 020 0012	12
A600 11 020 0016	16

Pediatric 90° Angled Connection Plate



SS	HOLES	LENGTH (mm)
A600 14 001 1150	2	41
A600 14 001 1175	4	65

Twisted Plate



SS	HOLES	LENGTH (mm)
A600 11 054 0046	2	45
A600 11 054 0067	3	63
A600 11 054 0088	4	81

Pediatric Female Support



SS	HOLES	LENGTH (mm)
A600 11 065 0000	1	22,5
A600 11 065 0002	2	31,5
A600 11 065 0003	3	40,5

Pediatric Threaded Socket



SS	LENGTH (mm)
A600 16 001 1115	15
A600 16 001 1125	25

Pediatric Circular External Fixators

Pediatric Trocar Pointed Wire



SS	DIA x LENGTH (mm)
A600 11 100 1520	1,5X200
A600 11 100 1525	1,5X250
A600 11 100 1820	1,8X200
A600 11 100 1825	1,8X250

Pediatric Bayonet Pointed Wire



SS	DIA x LENGTH (mm)
A600 11 135 1520	1,5X200
A600 11 135 1525	1,5X250
A600 11 135 1820	1,8X200
A600 11 135 1825	1,8X250

Pediatric Olive Wire



SS	DIA x LENGTH (mm)
A600 11 188 1520	1,5X200
A600 11 188 1525	1,5X250
A600 11 188 1820	1,8X200
A600 11 188 1825	1,8X250

Pediatric Threaded Rod (M5)



SS	LENGTH (mm)
A600 11 050 0040	40
A600 11 050 0050	50
A600 11 050 0060	60
A600 11 050 0080	80
A600 11 050 0090	90
A600 11 050 0100	100
A600 11 050 0120	120
A600 11 050 0150	150
A600 11 050 0180	180

"We supply WORLD's
Orthopedic & Trauma
Implants..."

Wires, Pins, Staples, & Drills Bits



Wires, Pins, Staples & Drill Bits

Kirschner Wires with Trocar Point

SS	DIAMETER (mm)	SS	DIAMETER (mm)
A100 03 070 0620	0,6	A100 03 070 2028	2,0
A100 03 070 0825	0,8	A100 03 070 2225	2,2
A100 03 070 0925	0,9	A100 03 070 2510	2,5
A100 03 070 1025	1,0	A100 03 070 2810	2,8
A100 03 070 1210	1,2	A100 03 070 3010	3,0
A100 03 070 1510	1,4	A100 03 070 3225	3,2
A100 03 070 1525	1,5	A100 03 070 3510	3,5
A100 03 070 1625	1,6	A100 03 070 4010	4,0
A100 03 070 1810	1,8	A100 03 070 4529	4,5
		A100 03 070 5025	5,0

Kirschner Wires with Double Trocar Point

SS	DIAMETER (mm)	SS	DIAMETER (mm)
A100 03 073 0625	0,6	A100 03 073 2012	2,0
A100 03 073 0812	0,8	A100 03 073 2212	2,2
A100 03 073 0925	0,9	A100 03 073 2510	2,5
A100 03 073 1012	1,0	A100 03 073 3015	2,8
A100 03 073 1212	1,2	A100 03 073 3010	3,0
A100 03 073 1429	1,4	A100 03 073 3229	3,2
A100 03 073 1512	1,5	A100 03 073 3510	3,5
A100 03 073 1629	1,6	A100 03 073 4010	4,0
A100 03 073 1812	1,8	A100 03 073 6032	4,5
		A100 03 073 5020	5,0

Wires, Pins, Staples & Drill Bits

Threaded Kirschner Wires with Trocar Point



SS	DIAMETER (mm)	SS	DIAMETER (mm)
A100 03 071 0020	2,0	A100 03 071 0032	3,2
A100 03 071 0025	2,5	A100 03 071 0035	3,5
A100 03 071 0030	3,0	A100 03 071 0040	4,0

Cerclage Wire



SS	DIA x LENGTH (mm)	SS	DIA x LENGTH (mm)
A400 03 011 0329	0,3X5000	A400 03 011 1019	1,0X5000
A400 03 011 0427	0,4X5000	A400 03 011 1218	1,2X5000
A400 03 011 0525	0,5X5000	A400 03 011 1517	1,5X5000
A400 03 011 0623	0,6X5000	A400 03 011 1826	1,8X5000
A400 03 011 0722	0,7X5000	A400 03 011 2027	2,0X5000
A400 03 011 0821	0,8X5000	A400 03 011 2328	2,3X5000
A400 03 011 0920	0,9X5000	A400 03 011 2529	2,5X5000

Steinmann Pin with Trocar Point



SS	DIAMETER (mm)	SS	DIAMETER (mm)
A100 03 050 1829	1,8	A100 03 050 4012	4,0
A100 03 050 2029	2,0	A100 03 050 4512	4,5
A100 03 050 2529	2,5	A100 03 050 5012	5,0
A100 03 050 3012	3,0	A100 03 050 6012	6,0
A100 03 050 3512	3,5		

Wires, Pins, Staples & Drill Bits

Steinmann Pins with Central Thread



SS	DIAMETER (mm)	THREAD LENGTH (mm)	SS	DIAMETER (mm)	THREAD LENGTH (mm)
A100 03 051 3230	3,0	60	A100 03 051 5230	5,0	60
A100 03 051 4230	4,0	60	A100 03 051 5524	5,5	60
A100 03 051 4523	4,5	60	A100 03 050 6018	6,0	60

Schanz Screw



SS	DIAMETER (mm)	SS	DIAMETER (mm)
A100 03 090 5012	1,5	A100 03 090 4011	4,0
A100 03 090 6026	2,0	A100 03 090 4517	4,5
A100 03 091 6020	2,5	A100 03 090 5013	5,0
A100 03 090 3115	3,0	A100 03 090 5515	5,5
A100 03 090 6030	3,5	A100 03 090 6012	6,0

Schanz Screw Cortical



SS	DIA.x LENGTH (mm)
A600 11 110 0130	6,0X130
A600 11 110 0115	6,0X150
A600 11 110 0160	6,0X160
A600 11 110 0180	6,0X180
A600 11 110 0200	6,0X200
A600 11 110 0220	6,0X220

Schanz Screw Cancellous



SS	DIA.x LENGTH (mm)
A600 11 111 0150	6,0X150
A600 11 111 0160	6,0X160
A600 11 111 0180	6,0X180
A600 11 111 0200	6,0X200
A600 11 111 0220	6,0X220

Calibrated Self Tapping Schanz Screw



SS	DIAMETER (mm)
A600 13 110 4018	4,0
A600 13 110 5013	5,0
A600 13 110 0160	6,0

Rush Intramedullary Pin



SS	DIAMETER (mm)	SS	DIAMETER (mm)
A100 04 051 2016	2,0	A100 04 051 4514	4,5
A100 04 051 2518	2,5	A100 04 051 5016	5,0
A100 04 051 3016	3,0	A100 04 051 5522	5,5
A100 04 051 3218	3,2	A100 04 051 6020	6,0
A100 04 051 3220	3,5	A100 04 051 7025	7,0
A100 04 051 4016	4,0		

Pelvic Traction Screw



SS	DIAMETER (mm)
A602 00 010 3232	3,2
A602 00 010 4545	4,5
A602 00 010 8016	8,0
A602 00 010 8020	8,0

Wires, Pins, Staples & Drill Bits

Epiphyseal Staple Stainless Steel

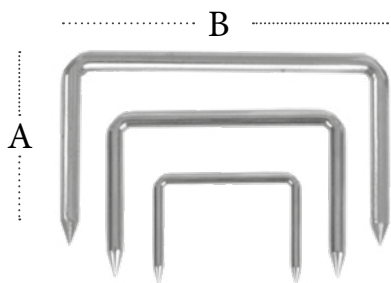

SS	A LENGTH (mm)	B LENGTH (mm)	DIAMETER (mm)
A100 03 110 0015	19	16	1,5
A100 03 110 0020	19	22	2,0
A100 03 110 0025	19	26	2,5

Coventry Staple Stainless Steel

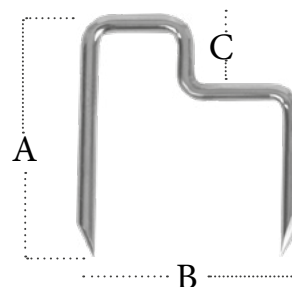

SS	A LENGTH (mm)	B LENGTH (mm)	C LENGTH (mm)	DIAMETER (mm)
A100 03 111 0140	33	25	14	2,5
A100 03 111 0050	33	25	10	2,5
A100 03 111 0100	33	25	5	2,5

Thorny Epiphyseal Staple Titanium

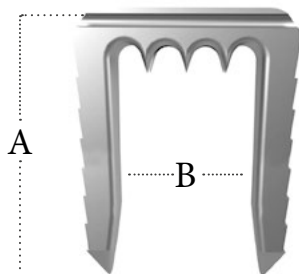

TI	A LENGTH (mm)	B LENGTH (mm)
A100 03 115 0650	20	6,5
A100 03 115 0800	20	8
A100 03 115 0115	20	10
A100 03 115 0150	20	15

Thorny Coventry Staple Titanium

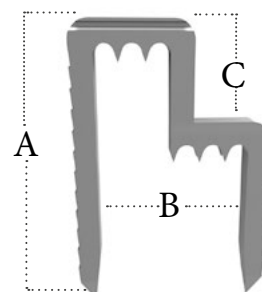

TI	A LENGTH (mm)	B LENGTH (mm)	C LENGTH (mm)
A100 03 111 0050	33	25	5
A100 03 111 0100	33	25	10
A100 03 111 0140	33	25	14
A100 03 111 0200	33	25	16

Thorny Washer



SS

A600 12 032 0000

Tibial Bolt



SS

DIAMETER
(mm)

A100 03 135 1000

3

A100 03 130 0800

4

Knowless Hip Pin



SS

DIAMETER
(mm)

A100 14 051 4070

3,0

A100 14 051 8075

3,2

A100 14 051 5060

4,0

A100 14 051 4585

4,5

A100 14 051 5016

5,0

Drill Bit



SS	DIAMETER (mm)
A101 03 090 0020	1,2
A101 03 091 0027	1,5
A101 03 091 0020	1,8
A101 03 090 2012	2,0
A101 03 090 2212	2,2
A101 03 091 0022	2,5
A101 03 090 2712	2,7
A101 03 092 0030	3,0
A101 03 090 3212	3,2
A101 03 090 3512	3,5
A101 03 090 0045	3,7
A101 03 092 0040	4,0
A101 03 090 4512	4,5
A101 03 090 4028	5,0
A101 03 090 0032	5,5
A101 03 091 0045	6,0

Gigli Saw



SS	LENGTH (mm)
A400 09 111 1030	300
A400 09 111 1040	400
A400 09 111 1050	500
A400 09 111 1060	600



STERILIZATION CONTAINERS
AND ACCESSORIES



ORTHOPEDIC SURGICAL
INSTRUMENTS



ORTHOPEDIC
INSTRUMENT CONTAINERS



ORTHOPEDIC SURGERY
INSTRUMENT SETS

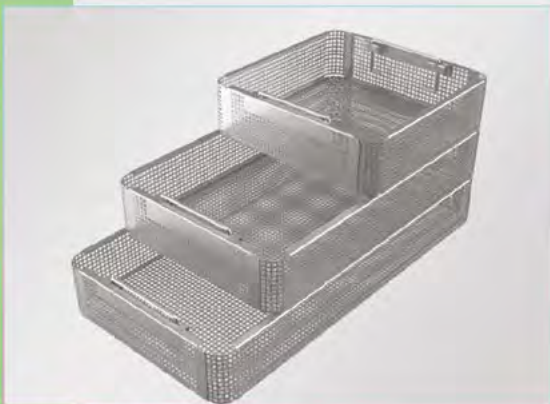

PERFORATED
SHEET BASKETS



ORTHOPAEDICS & MEDICAL DEVICES

ISTANBUL

Molla Gürani Mah. Molla Gürani Cad. No:59/9 Fındıkzade/Fatih
+90 212 531 12 00
istanbul@aysam.com.tr

SAMSUN

Ulugazi Mah. İstiklal Cad. No: 28/5 SAMSUN
Tel: +90 362 435 37 72 - Fax: +90 362 420 02 94
export@aysam.com.tr

WORKSHOP

Organize Sanayi Sitesi M.Erdoğan Cebeci Bulv. No: 34 Kutlukent / SAMSUN
Tel: +90 362 266 69 70
fabrika@aysam.com.tr

WAREHOUSE

Kirazlık Mah 1034 Cd. No:14 TEKKEKÖY/SAMSUN/TÜRKİYE
Tel: +90 362 435 37 72
depo@aysam.com.tr



quality & trust

